

# Damping Technology

ACE: Your partner for industrial shock absorbers, gas springs and vibration control

Main Catalogue 2017

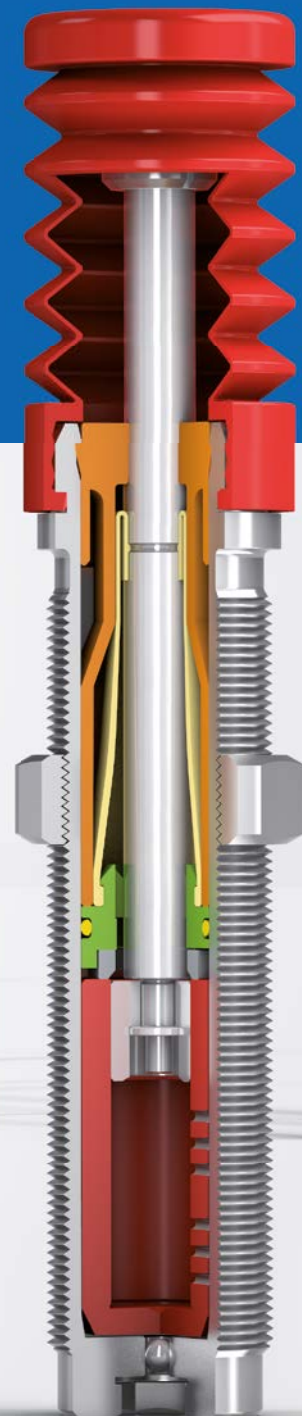

**Complete Product Range  
Data Sheets & Catalogues  
CAD Database  
Free Calculation Programs  
Distributors  
Services  
News  
etc.**

**[www.ace-ace.com](http://www.ace-ace.com)**

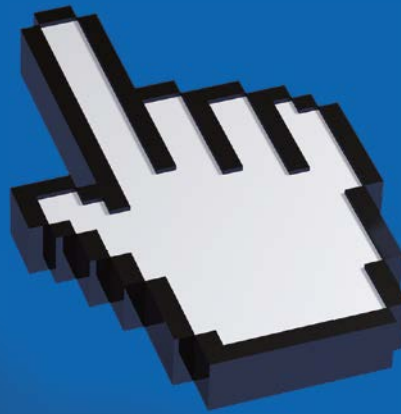



## Dear customer,

You have made the right decision.

You will find 300 pages of comprehensive information on the application fields of automation control, motion control, vibration control and safety products. Each section is marked with a different colour. This integrated concept is reflected in all documentation, the demonstration vehicle, our exhibition stand and our [www.ace-ace.com](http://www.ace-ace.com) website. Our web presentation, the tool for professionals, also offers the ACE YouTube channel with an extensive CAD library and calculation aids.

Innovations can as usual be found in the table of contents and on the individual catalogue pages.

ACE products assist you in making your production and processes faster, more efficient, quieter, easier, safer and more sustainable – underpinned by ACE product quality and our 5 star service.

## Your

Jürgen Roland (Managing Director)



### Free Service Hotline

Tell us about your requirements and take advantage of our more than 40 years of expert knowledge in damping technology. Our specialists in engineering discuss your requirements with you and demonstrate our possibilities. Take advantage of our service hotline

**T +49 (0)2173 - 9226-4100**

Also, our regional managers are genuine shock absorber specialists. They will visit you onsite, note down the field data and work out customized solutions for you.

Furthermore: ACE service support and products are available in more than 40 countries worldwide.

### CAD Online Calculation Program

With our user-friendly calculation program in the internet you can select the right product – online or via download of the program. The CAD data is available in all standard formats in 2D and 3D.

[www.ace-ace.com](http://www.ace-ace.com)

Our specialist engineers create detailed technical solutions for you including assembly suggestions and details on machine loads, brake time and workload etc.

# Automation Control

# Motion Control

# Vibration Control

# Safety Products



## Certified Quality

ACE products are exclusively manufactured from high quality and environmentally compatible materials. With permanent quality monitoring and the performance of test programs, a constant high quality can be guaranteed.

ACE pursues continual improvement in all areas in order to arrange material and energy consumption, the production of damaging substances and recycling or disposal of end products as gently on resources as possible.

It is important to us to keep the strain on the environment as low as possible and simultaneously improve our services.

With ongoing optimisation of end products, we also give our customers the option of designing their products to be smaller, more effective and more energy-saving.



Miniature Shock Absorbers, Industrial Shock Absorbers, Heavy Industrial Shock Absorbers, Pallet Stoppers, Profile Dampers, Damping Pads



Industrial Gas Springs (push type), Industrial Gas Springs (pull type), Hydraulic Dampers, Hydraulic Feed Controls, Door Dampers, Rotary Dampers



Rubber-Metal Isolators, Vibration-Isolating Pads, Low Frequency Pneumatic Levelling Mounts



Safety Shock Absorbers, Safety Dampers, Clamping Elements

## We are your Specialists for Industrial Damping Technology

**ACE is the world's globally recognized specialist in the field of industrial damping technology – with agencies in 45 countries on all continents. ACE has also been represented in Germany since 1978. Here 25 engineers work every day on the further development of the product range.**

ACE customers benefit from sophisticated solutions, valuable innovations and exemplary service around the topic of damping technology. Through close cooperation with leading engineering companies, in particular the German ACE subsidiary has established itself as a pioneer in the field of technical progress in damping technology.

This catalogue is the decisive step to let the frequently expressed customer request come true: to supply everything for damping technology and vibration isolation from one single source.

ACE develops, produces and sells a wide range of damping products. It comprises industrial and safety shock absorbers, profile dampers, rotary dampers, industrial gas springs, hydraulic dampers, vibration isolators, air springs and hydraulic feed controls.

The products assert themselves particularly in future-oriented companies because there are virtually no better solutions to quickly, gently and precisely slow down moving masses or to isolate harmful vibrations.

# ACE Product Variety

Concentrated competence on more than 300 pages



| Page       |   |
|------------|---|
| <b>6</b>   | <b>Automation Control</b>                         |
| 8 - 9      | Industrial shock absorbers – general information  |
| 10 - 13    | Formulae and calculations                         |
| 14 - 15    | Industrial shock absorbers – capacity chart       |
| <b>16</b>  | <b>Miniature Shock absorbers</b>                  |
|            | <b>Product families</b>                           |
| 18 - 35    | Accessories M5 to M25 – selection chart           |
| 36 - 37    | Accessories M5 to M25 – overview                  |
| 38 - 42    | Accessories M5 to M25 – technical information     |
| 43 - 46    | Accessories M5 to M25 – technical information     |
| 48 - 49    | Application examples                              |
| <b>50</b>  | <b>Industrial Shock Absorbers</b>                 |
|            | <b>Product families</b>                           |
| 52 - 73    | Accessories M33 to M64 – overview                 |
| 74 - 76    | Accessories M33 to M64 – technical information    |
| 77         | Accessories M33 to M64 – technical information    |
| 78 - 79    | Application examples                              |
| <b>80</b>  | <b>Heavy Industrial Shock Absorbers</b>           |
|            | <b>Product families</b>                           |
| 82 - 89    | Special accessories – air/oil tanks               |
| 90 - 91    | Special accessories – air/oil tanks               |
| <b>92</b>  | <b>Pallet Stoppers</b>                            |
| <b>96</b>  | <b>Profile Dampers TUBUS</b>                      |
| 98 - 99    | Profile dampers – capacity chart                  |
| 100 - 111  | <b>Product families</b>                           |
| 112 - 113  | Application examples                              |
| <b>114</b> | <b>Profile Dampers TUBUS Special</b>              |
| <b>116</b> | <b>Damping Pads SLAB</b>                          |
|            | <b>Product families</b>                           |
| 118 - 124  | Adhesive recommendation and technical information |
| 125        | Adhesive recommendation and technical information |
| 126        | Chemical resistance                               |
| 127        | Sample pads                                       |
| 128 - 129  | Application examples                              |

## 130

## Motion Control

### 132

134 - 155

153

156 - 157

### Gas Springs – Push Type

#### Product families

Further stainless steel gas springs – capacity chart

Application examples

### 158

160 - 170

171

172 - 173

174

175

### Gas Springs – Pull Type

#### Product families

Further stainless steel gas springs – capacity chart

Gas spring calculation service and fax formular

Mounting and safety instructions

Special accessories – valve actuation and refilling kit

### 176

178 - 197

198 - 199

200 - 213

### Hydraulic Dampers

#### Product families

Application examples

Accessories for gas springs and hydraulic dampers

### 214

216 - 219

### Hydraulic Feed Controls

#### Product families

### 220

224 - 237

238

239

### Rotary Dampers

#### Product families

Calculations and accessories

Application examples

## 240

## Vibration Control

242

Vibration isolation

### 243

### Rubber-Metal Isolators

### 244

### Vibration-Isolating Pads

### 245

### Low Frequency Pneumatic Levelling Mounts

## 246

## Safety Products

### 248

250 - 263

264

265

266 - 267

### Safety Shock Absorbers

#### Product families

General instructions

Formulae and calculations

Application examples

### 268

270 - 273

### Safety Dampers TUBUS

#### Product families

### 274

276 - 278

280 - 296

297 - 298

### Clamping Elements

Clamp versions

#### Product families

Application examples

# Automation Control

Miniature Shock Absorbers, Industrial Shock Absorbers  
Heavy Industrial Shock Absorbers, Pallet Stoppers  
Profile Dampers, Damping Pads



## Optimum Tuning

### Tailor-made solutions for any application

**Kinetic energy is turned into heat by the universal use ACE damping solutions. This makes machines faster, quieter, more durable, lighter and therefore more competitive and profitable.**

Here you will find the perfect selection of machine element, which turn damaging forces into harmless heat. These solutions from ACE smoothly decelerate moving loads. This involves the lowest possible strain on machines, which makes the damping products from ACE so valuable.





# Industrial Shock Absorbers

## Standard-setting damping solutions

The name says it all: **ACE Stoßdämpfer GmbH** (“the ACE shock absorber company”). That ACE is considered the technology and market leader on a worldwide scale for small, medium-sized and heavy industrial shock absorbers is a result of the successful blend of quality, performance and the durability of the solutions.

ACE provides the right shock absorber for every industrial purpose. Over 200 different models are available, from the smallest model with a 4 mm stroke up to the biggest with 406 mm.

Whether self-compensating or adjustable, with ACE dampers between 0.68 Nm/cycle and 126,500 Nm/cycle can be absorbed and effective weights between 500 g and 204 t can be decelerated with great precision.

In addition, ACE damping solutions impress with competent consulting, exemplary service and ideal matching accessories.



ACE demo showing a wine glass dropping free fall 1.3 m. Decelerated by a shock absorber not a drop of wine is spilled.

### Stopping with Industrial Shock Absorbers

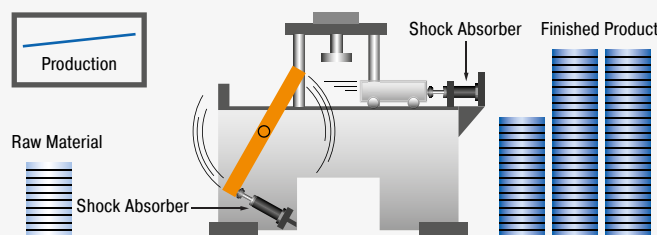

#### Your advantages using industrial shock absorbers

- Safe, reliable production
- Long service life of the machines
- Easy, inexpensive constructions
- Low operating costs
- Quiet, economical machines
- Less stress on the machine
- Profit improvement

### Stopping with Rubber Buffers, Springs, Dashpots or Cylinder Cushions

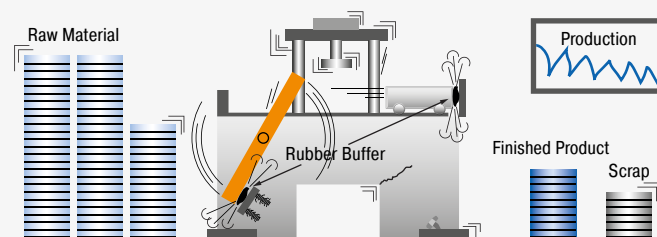

#### Results using conventional dampers

- Loss of production
- Machine damage
- Increased maintenance costs
- Increased operating noise
- Higher machine construction costs

## Comparison of Different Damping Elements

When it comes to slowing down moving masses with constant damping force through the stroke, the industrial shock absorber is the right choice. A comparison demonstrates the differences of the damping elements.

### ACE Industrial Shock Absorbers (Uniform stopping force through the entire stroke)

The moving load is smoothly and gently brought to rest by a constant resisting force throughout the entire shock absorber stroke. The load is decelerated with the lowest possible force in the shortest possible time eliminating damaging force peaks and shock damage to machines and equipment. This is a linear deceleration force stroke curve and is the curve provided by ACE industrial shock absorbers. In addition they considerably reduce noise pollution.

### Hydraulic Dashpot (High stopping force at start of the stroke)

With only one metering orifice the moving load is abruptly slowed down at the start of the stroke. The braking force rises to a very high peak at the start of the stroke (giving high shock loads) and then falls away rapidly.

### Springs and Rubber Buffers (High stopping forces at end of stroke)

At full compression. Also they store energy rather than dissipating it, causing the load to rebound back again.

### Air Buffers, Pneumatic Cylinder Cushions (High stopping force at end of stroke)

Due to the compressibility of air these have a sharply rising force characteristic towards the end of the stroke. The majority of the energy is absorbed near the end of the stroke.

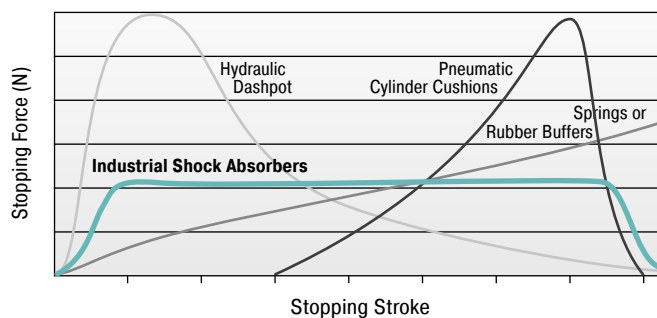

#### Comparison

The comparison shows the differences of the damping in a direct comparison of stopping force to stopping stroke.

## General Function of the Pressure Chamber

If a moving mass hits the industrial shock absorber, the piston puts the oil in the pressure chamber into motion. The oil is pressed through the metering orifices, which converts the discharged energy into heat. The metering orifices are arranged on the stroke so that the mass is retarded with a constant damping force. The hydraulic pressure is maintained throughout the entire braking process nearly constant.

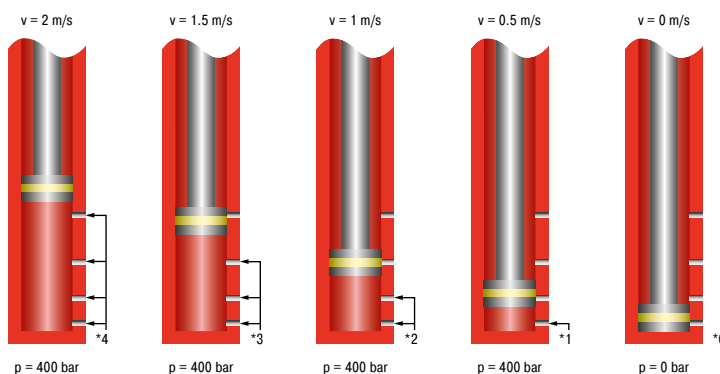

\* The load velocity reduces continuously as you travel through the stroke due to the reduction in the number of metering orifices (\*) in action. The internal pressure remains essentially constant and thus the force vs. stroke curve remains linear.

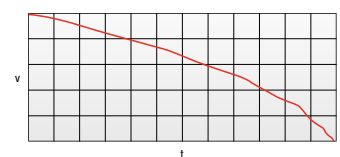
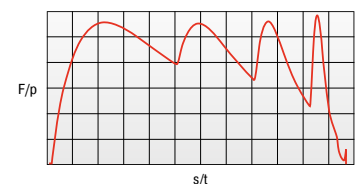

F = force (N), p = internal pressure (bar)  
s = stroke (m), t = deceleration time (s),  
v = velocity (m/s)

## Calculation Bases for the Design of Industrial Shock Absorbers

ACE shock absorbers provide linear deceleration and are therefore superior to other kinds of damping element. It is easy to calculate around 90 % of applications knowing only the following five parameters:

1. Mass to be decelerated (weight) **m** [kg]
2. Impact velocity at shock absorber **v<sub>D</sub>** [m/s]
3. Propelling force **F** [N]
4. Cycles per hour **c** [/hr]
5. Number of absorbers in parallel **n**

### Key to symbols used

|                             |   |       |                 |   |                  |
|-----------------------------|---|-------|-----------------|---|------------------|
| $W_1$                       | Kinetic energy per cycle                | Nm    | <sup>3</sup> ST | tall torque factor (normally 2.5)       | 1 to 3           |
| $W_2$                       | Propelling force energy per cycle       | Nm    | M               | Propelling torque                       | Nm               |
| $W_3$                       | Total energy per cycle ( $W_1 + W_2$ )  | Nm    | I               | Moment of Inertia                       | kgm <sup>2</sup> |
| <sup>1</sup> $W_4$          | Total energy per hour ( $W_3 \cdot c$ ) | Nm/hr | g               | Acceleration due to gravity = 9.81      | m/s <sup>2</sup> |
| me                          | Effective weight                        | kg    | h               | Drop height excl. shock absorber stroke | m                |
| m                           | Mass to be decelerated                  | kg    | s               | Shock absorber stroke                   | m                |
| n                           | Number of shock absorbers (in parallel) |       | L/R/r           | Radius                                  | m                |
| <sup>2</sup> v              | Velocity at impact                      | m/s   | Q               | Reaction force                          | N                |
| <sup>2</sup> v <sub>D</sub> | Impact velocity at shock absorber       | m/s   | μ               | Coefficient of friction                 |                  |
| ω                           | Angular velocity at impact              | rad/s | t               | Deceleration time                       | s                |
| F                           | Propelling force                        | N     | a               | Deceleration                            | m/s <sup>2</sup> |
| c                           | Cycles per hour                         | 1/hr  | α               | Side load angle                         | °                |
| P                           | Motor power                             | kW    | β               | Angle of incline                        | °                |

<sup>1</sup> All mentioned values of  $W_4$  in the capacity charts are only valid for room temperature. There are reduced values at higher temperature ranges.

<sup>2</sup> v or v<sub>D</sub> is the final impact velocity of the mass. With accelerating motion the final impact velocity can be 1.5 to 2 times higher than the average. Please take this into account when calculating kinetic energy.

<sup>3</sup> ST ≙ relation between starting torque and running torque of the motor (depending on the design)

In all the following examples the choice of shock absorbers made from the capacity chart is based upon the values of ( $W_3$ ), ( $W_4$ ), (me) and the desired shock absorber stroke (s).

### Note:

When using several shock absorbers in parallel, the values ( $W_3$ ), ( $W_4$ ) and (me) are divided according to the number of units used.

$$\text{Reaction force } Q \text{ [N]} \quad Q = \frac{1.5 \cdot W_3}{s}$$

$$\text{Stopping time } t \text{ [s]} \quad t = \frac{2.6 \cdot s}{v_D}$$

$$\text{Deceleration rate } a \text{ [m/s}^2\text{]} \quad a = \frac{0.75 \cdot v_D^2}{s}$$

Approximate values assuming correct adjustment. Add safety margin if necessary.  
(Exact values will depend upon actual application data and can be provided on request.)

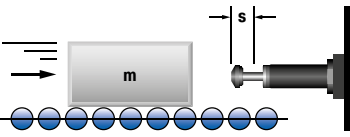
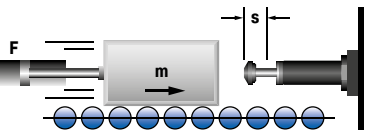
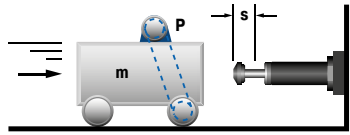
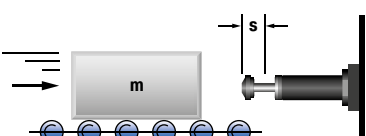
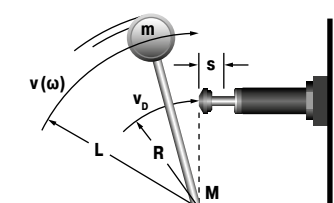
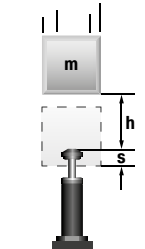
| Application   | Formulae  | Example   |
|---|---|---|
| <b>1 Mass without propelling force</b><br>         | $W_1 = m \cdot v^2 \cdot 0.5$<br>$W_2 = 0$<br>$W_3 = W_1 + W_2$<br>$W_4 = W_3 \cdot c$<br>$v_D = v$<br>$me = m$   | $m = 100 \text{ kg}$<br>$v = 1.5 \text{ m/s}$<br>$c = 500 \text{ /hr}$<br>$s = 0.050 \text{ m (chosen)}$<br><br>$W_1 = 100 \cdot 1.5^2 \cdot 0.5 = 113 \text{ Nm}$<br>$W_2 = 0$<br>$W_3 = 113 + 0 = 113 \text{ Nm}$<br>$W_4 = 113 \cdot 500 = 56500 \text{ Nm/hr}$<br>$me = m = 100 \text{ kg}$<br><br>Chosen from capacity chart:<br>Model MC3350EUM-2 self-compensating   |
| <b>2 Mass with propelling force</b><br>            | $W_1 = m \cdot v^2 \cdot 0.5$<br>$W_2 = F \cdot s$<br>$W_3 = W_1 + W_2$<br>$W_4 = W_3 \cdot c$<br>$v_D = v$<br>$me = \frac{2 \cdot W_3}{v_D^2}$   | $m = 36 \text{ kg}$<br>$v = 1.5 \text{ m/s}$<br>$F = 400 \text{ N}$<br>$c = 1000 \text{ /hr}$<br>$s = 0.025 \text{ m (chosen)}$<br><br>$W_1 = 36 \cdot 1.5^2 \cdot 0.5 = 41 \text{ Nm}$<br>$W_2 = 400 \cdot 0.025 = 10 \text{ Nm}$<br>$W_3 = 41 + 10 = 51 \text{ Nm}$<br>$W_4 = 51 \cdot 1000 = 51000 \text{ Nm/hr}$<br>$me = 2 \cdot 51 : 1.5^2 = 45 \text{ kg}$<br><br>Chosen from capacity chart:<br>Model MC600EUM self-compensating<br><br>$v$ is the final impact velocity of the mass: With pneumatically propelled systems this can be 1.5 to 2 times the average velocity. Please take this into account when calculating energy.  |
| <b>2.1 for vertical motion upwards</b> →<br><b>2.2 for vertical motion downwards</b> →  | $W_2 = (F - m \cdot g) \cdot s$<br>$W_2 = (F + m \cdot g) \cdot s$  |   |
| <b>3 Mass with motor drive</b><br>                | $W_1 = m \cdot v^2 \cdot 0.5$<br>$W_2 = \frac{1000 \cdot P \cdot ST \cdot s}{v}$<br>$W_3 = W_1 + W_2$<br>$W_4 = W_3 \cdot c$<br>$v_D = v$<br>$me = \frac{2 \cdot W_3}{v_D^2}$   | $m = 800 \text{ kg}$<br>$v = 1.2 \text{ m/s}$<br>$ST = 2.5$<br>$P = 4 \text{ kW}$<br>$c = 100 \text{ /hr}$<br>$s = 0.100 \text{ m (chosen)}$<br><br>$W_1 = 800 \cdot 1.2^2 \cdot 0.5 = 576 \text{ Nm}$<br>$W_2 = 1000 \cdot 4 \cdot 2.5 \cdot 0.1 : 1.2 = 834 \text{ Nm}$<br>$W_3 = 576 + 834 = 1410 \text{ Nm}$<br>$W_4 = 1410 \cdot 100 = 141000 \text{ Nm/hr}$<br>$me = 2 \cdot 1410 : 1.2^2 = 1958 \text{ kg}$<br><br>Chosen from capacity chart:<br>Model MC64100EUM-2 self-compensating<br>Note: Do not forget to include the rotational energy of motor, coupling and gearbox into calculation for $W_1$ .   |
| <b>4 Mass on driven rollers</b><br>              | $W_1 = m \cdot v^2 \cdot 0.5$<br>$W_2 = m \cdot \mu \cdot g \cdot s$<br>$W_3 = W_1 + W_2$<br>$W_4 = W_3 \cdot c$<br>$v_D = v$<br>$me = \frac{2 \cdot W_3}{v_D^2}$   | $m = 250 \text{ kg}$<br>$v = 1.5 \text{ m/s}$<br>$c = 180 \text{ /hr}$<br>$(\text{Steel/Steel}) \mu = 0.2$<br>$s = 0.050 \text{ m (chosen)}$<br><br>$W_1 = 250 \cdot 1.5^2 \cdot 0.5 = 281 \text{ Nm}$<br>$W_2 = 250 \cdot 0.2 \cdot 9.81 \cdot 0.05 = 25 \text{ Nm}$<br>$W_3 = 281 + 25 = 306 \text{ Nm}$<br>$W_4 = 306 \cdot 180 = 55080 \text{ Nm/hr}$<br>$me = 2 \cdot 306 : 1.5^2 = 272 \text{ kg}$<br><br>Chosen from capacity chart:<br>Model MC4550EUM-2 self-compensating  |
| <b>5 Swinging mass with propelling force</b><br> | $W_1 = m \cdot v^2 \cdot 0.5 = 0.5 \cdot l \cdot \omega^2$<br>$W_2 = \frac{M \cdot s}{R}$<br>$W_3 = W_1 + W_2$<br>$W_4 = W_3 \cdot c$<br>$v_D = \frac{v \cdot R}{L} = \omega \cdot R$<br>$me = \frac{2 \cdot W_3}{v_D^2}$ | $m = 20 \text{ kg}$<br>$v = 1 \text{ m/s}$<br>$M = 50 \text{ Nm}$<br>$R = 0.5 \text{ m}$<br>$L = 0.8 \text{ m}$<br>$c = 1500 \text{ /hr}$<br>$s = 0.012 \text{ m (chosen)}$<br><br>$W_1 = 20 \cdot 1^2 \cdot 0.5 = 10 \text{ Nm}$<br>$W_2 = 50 \cdot 0.012 : 0.5 = 1.2 \text{ Nm}$<br>$W_3 = 10 + 1.2 = 11.2 \text{ Nm}$<br>$W_4 = 11.2 \cdot 1500 = 16800 \text{ Nm/hr}$<br>$v_D = 1 \cdot 0.5 : 0.8 = 0.63 \text{ m/s}$<br>$me = 2 \cdot 11.2 : 0.63^2 = 56 \text{ kg}$<br><br>Chosen from capacity chart:<br>Model MC150EUMH self-compensating<br>Check the side load angle, $\tan \alpha = s/R$ , with regard to "Max. Side Load Angle" in the capacity chart (see example 6.2) |
| <b>6 Free falling mass</b><br>                   | $W_1 = m \cdot g \cdot h$<br>$W_2 = m \cdot g \cdot s$<br>$W_3 = W_1 + W_2$<br>$W_4 = W_3 \cdot c$<br>$v_D = \sqrt{2 \cdot g \cdot h}$<br>$me = \frac{2 \cdot W_3}{v_D^2}$  | $m = 30 \text{ kg}$<br>$h = 0.5 \text{ m}$<br>$c = 400 \text{ /hr}$<br>$s = 0.050 \text{ m (chosen)}$<br><br>$W_1 = 30 \cdot 0.5 \cdot 9.81 = 147 \text{ Nm}$<br>$W_2 = 30 \cdot 9.81 \cdot 0.05 = 15 \text{ Nm}$<br>$W_3 = 147 + 15 = 162 \text{ Nm}$<br>$W_4 = 162 \cdot 400 = 64800 \text{ Nm/hr}$<br>$v_D = \sqrt{2 \cdot 9.81 \cdot 0.5} = 3.13 \text{ m/s}$<br>$me = 2 \cdot 162 : 3.13^2 = 33 \text{ kg}$<br><br>Chosen from capacity chart:<br>Model MC3350EUM-1 self-compensating  |

| Application   | Formulae   | Example   |
|---|--|---|
| <p><b>6.1 Mass rolling/sliding down incline</b></p> <p>6.1a propelling force up incline →</p> <p>6.1b propelling force down incline →</p> | $W_1 = m \cdot g \cdot h = m \cdot v_D^2 \cdot 0.5$ $W_2 = m \cdot g \cdot \sin\beta \cdot s$ $W_3 = W_1 + W_2$ $W_4 = W_3 \cdot c$ $v_D = \sqrt{2 \cdot g \cdot h}$ $m_e = \frac{2 \cdot W_3}{v_D^2}$                                     | <p><math>m = 500 \text{ kg}</math><br/> <math>h = 0.1 \text{ m}</math><br/> <math>c = 200 \text{ /hr}</math><br/> <math>\beta = 10 \text{ }^\circ\text{C}</math></p> <p><math>W_1 = 500 \cdot 9.81 \cdot 0.1 = 490.5 \text{ Nm}</math><br/> <math>W_2 = 50 \cdot 9.81 \cdot \sin(10) \cdot 0.075 = 63.9 \text{ Nm}</math><br/> <math>W_3 = 490.5 + 63.9 = 554.4 \text{ Nm}</math><br/> <math>W_4 = 554.4 \cdot 200 = 11880.0 \text{ Nm/hr}</math></p> <p>Chosen from capacity chart:<br/>                 Model MC4575EUM-2 self-compensating</p>   |
| <p><b>6.2 Mass free falling about a pivot point</b></p> <p><math>\tan \alpha = \frac{s}{R}</math></p>                                     | $W_1 = m \cdot g \cdot h$ $W_2 = 0$ $W_3 = W_1 + W_2$ $W_4 = W_3 \cdot c$ $v_D = \sqrt{2 \cdot g \cdot h} \cdot \frac{R}{L}$ $m_e = \frac{2 \cdot W_3}{v_D^2}$   | <p><math>m = 50 \text{ kg}</math><br/> <math>h = 1 \text{ m}</math><br/> <math>c = 50 \text{ /hr}</math><br/> <math>R = 300 \text{ mm}</math><br/> <math>L = 500 \text{ mm}</math></p> <p><math>W_1 = 50 \cdot 9.81 \cdot 1 = 490.5 \text{ Nm}</math><br/> <math>W_2 = 0</math><br/> <math>W_3 = 490.5 + 0 = 490.5 \text{ Nm}</math><br/> <math>W_4 = 490.5 \cdot 50 = 24525.0 \text{ Nm/hr}</math></p> <p>Chosen from capacity chart:<br/>                 Model MC4550EUM-1 self-compensating</p> <p>Check the side load angle, <math>\tan \alpha = s/R</math>, with regard to "Max. Side Load Angle" in the capacity chart</p>   |
| <p><b>7 Rotary index table with propelling torque</b></p>   | $W_1 = m \cdot v^2 \cdot 0.25 = 0.5 \cdot l \cdot \omega^2$ $W_2 = \frac{M \cdot s}{R}$ $W_3 = W_1 + W_2$ $W_4 = W_3 \cdot c$ $v_D = \frac{v \cdot R}{L} = \omega \cdot R$ $m_e = \frac{2 \cdot W_3}{v_D^2}$                               | <p><math>m = 1000 \text{ kg}</math><br/> <math>v = 1.1 \text{ m/s}</math><br/> <math>M = 1000 \text{ Nm}</math><br/> <math>s = 0.050 \text{ m (chosen)}</math><br/> <math>L = 1.25 \text{ m}</math><br/> <math>R = 0.8 \text{ m}</math><br/> <math>c = 100 \text{ /hr}</math></p> <p><math>W_1 = 1000 \cdot 1.1^2 \cdot 0.25 = 303 \text{ Nm}</math><br/> <math>W_2 = 300 \cdot 0.025 \cdot 0.8 = 63 \text{ Nm}</math><br/> <math>W_3 = 28 + 9 = 366 \text{ Nm}</math><br/> <math>W_4 = 37 \cdot 1200 = 36600 \text{ Nm/hr}</math><br/> <math>v_D = 1.1 \cdot 0.8 \cdot 1.25 = 0.7 \text{ m/s}</math><br/> <math>m_e = 2 \cdot 366 \cdot 0.7^2 = 1494 \text{ kg}</math></p> <p>Chosen from capacity chart:<br/>                 Model MC4550EUM-3 self-compensating</p> <p>Check the side load angle, <math>\tan \alpha = s/R</math>, with regard to "Max. Side Load Angle" in the capacity chart (see example 6.2)</p> |
| <p><b>8 Swinging arm with propelling torque (uniform weight distribution)</b></p>   | $W_1 = m \cdot v^2 \cdot 0.17 = 0.5 \cdot l \cdot \omega^2$ $W_2 = \frac{M \cdot s}{R}$ $W_3 = W_1 + W_2$ $W_4 = W_3 \cdot c$ $v_D = \frac{v \cdot R}{L} = \omega \cdot R$ $m_e = \frac{2 \cdot W_3}{v_D^2}$                               | <p><math>l = 56 \text{ kgm}^2</math><br/> <math>\omega = 1 \text{ rad/s}</math><br/> <math>M = 300 \text{ Nm}</math><br/> <math>s = 0.025 \text{ m (chosen)}</math><br/> <math>L = 1.5 \text{ m}</math><br/> <math>R = 0.8 \text{ m}</math><br/> <math>c = 1200 \text{ /hr}</math></p> <p><math>W_1 = 0.5 \cdot 56 \cdot 1^2 = 28 \text{ Nm}</math><br/> <math>W_2 = 300 \cdot 0.025 \cdot 0.8 = 9 \text{ Nm}</math><br/> <math>W_3 = 28 + 9 = 37 \text{ Nm}</math><br/> <math>W_4 = 37 \cdot 1200 = 44400 \text{ Nm/hr}</math><br/> <math>v_D = 1 \cdot 0.8 = 0.8 \text{ m/s}</math><br/> <math>m_e = 2 \cdot 37 \cdot 0.8^2 = 116 \text{ kg}</math></p> <p>Chosen from capacity chart:<br/>                 Model MC600EUM self-compensating</p> <p>Check the side load angle, <math>\tan \alpha = s/R</math>, with regard to "Max. Side Load Angle" in the capacity chart (see example 6.2)</p>                      |
| <p><b>9 Swinging arm with propelling force (uniform weight distribution)</b></p>  | $W_1 = m \cdot v^2 \cdot 0.17 = 0.5 \cdot l \cdot \omega^2$ $W_2 = \frac{F \cdot r \cdot s}{R} = \frac{M \cdot s}{R}$ $W_3 = W_1 + W_2$ $W_4 = W_3 \cdot c$ $v_D = \frac{v \cdot R}{L} = \omega \cdot R$ $m_e = \frac{2 \cdot W_3}{v_D^2}$ | <p><math>m = 1000 \text{ kg}</math><br/> <math>v = 2 \text{ m/s}</math><br/> <math>F = 7000 \text{ N}</math><br/> <math>M = 4200 \text{ Nm}</math><br/> <math>s = 0.050 \text{ m (chosen)}</math><br/> <math>r = 0.6 \text{ m}</math><br/> <math>R = 0.8 \text{ m}</math><br/> <math>L = 1.2 \text{ m}</math><br/> <math>c = 900 \text{ /hr}</math></p> <p><math>W_1 = 1000 \cdot 2^2 \cdot 0.17 = 680 \text{ Nm}</math><br/> <math>W_2 = 7000 \cdot 0.6 \cdot 0.05 : 0.8 = 263 \text{ Nm}</math><br/> <math>W_3 = 680 + 263 = 943 \text{ Nm}</math><br/> <math>W_4 = 943 \cdot 900 = 848700 \text{ Nm/hr}</math><br/> <math>v_D = 2 \cdot 0.8 \cdot 1.2 = 1.33 \text{ m/s}</math><br/> <math>m_e = 2 \cdot 943 \cdot 1.33^2 = 1066 \text{ kg}</math></p> <p>Chosen from capacity chart:<br/>                 Model CA2x2EU-1 self-compensating</p>   |
| <p><b>10 Mass lowered at controlled speed</b></p>   | $W_1 = m \cdot v^2 \cdot 0.5$ $W_2 = m \cdot g \cdot s$ $W_3 = W_1 + W_2$ $W_4 = W_3 \cdot c$ $v_D = v$ $m_e = \frac{2 \cdot W_3}{v_D^2}$  | <p><math>m = 6000 \text{ kg}</math><br/> <math>v = 1.5 \text{ m/s}</math><br/> <math>s = 0.305 \text{ m (chosen)}</math><br/> <math>c = 60 \text{ /hr}</math></p> <p><math>W_1 = 6000 \cdot 1.5^2 \cdot 0.5 = 6750 \text{ Nm}</math><br/> <math>W_2 = 6000 \cdot 9.81 \cdot 0.305 = 17952 \text{ Nm}</math><br/> <math>W_3 = 6750 + 17952 = 24702 \text{ Nm}</math><br/> <math>W_4 = 24702 \cdot 60 = 1482120 \text{ Nm/hr}</math><br/> <math>m_e = 2 \cdot 24702 \cdot 1.5^2 = 21957 \text{ kg}</math></p> <p>Chosen from capacity chart:<br/>                 Model CA3x12EU-2 self-compensating</p>  |

### Effective Weight (me)

The effective weight (me) can either be the same as the actual weight (examples A and C), or it can be an imaginary weight representing a combination of the propelling force or lever action plus the actual weight (examples B and D).

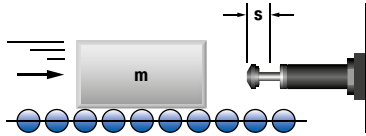
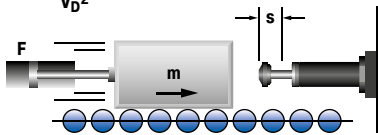
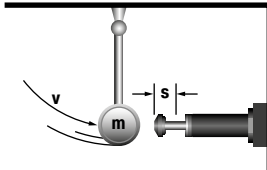
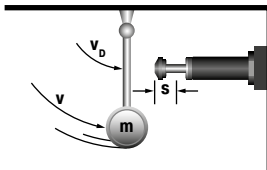
| Application   | Example  |
|---|--|
| <p><b>A Mass without propelling force</b></p> <p>Formula<br/> <math>me = m</math></p>    | <p><math>m = 100 \text{ kg}</math><br/> <math>v_D = v = 2 \text{ m/s}</math><br/> <math>W_1 = W_3 = 200 \text{ Nm}</math><br/> <math>me = \frac{2 \cdot 200}{4} = 100 \text{ kg}</math></p>  |
| <p><b>B Mass with propelling force</b></p> <p>Formula<br/> <math>me = \frac{2 \cdot W_3}{v_D^2}</math></p>                               | <p><math>m = 100 \text{ kg}</math><br/> <math>F = 2000 \text{ N}</math><br/> <math>v_D = v = 2 \text{ m/s}</math><br/> <math>s = 0.1 \text{ m}</math><br/> <math>W_1 = 200 \text{ Nm}</math><br/> <math>W_2 = 200 \text{ Nm}</math><br/> <math>W_3 = 400 \text{ Nm}</math><br/> <math>me = \frac{2 \cdot 400}{4} = 200 \text{ kg}</math></p> |
| <p><b>C Mass without propelling force direct against shock absorber</b></p> <p>Formula<br/> <math>me = m</math></p>                      | <p><math>m = 20 \text{ kg}</math><br/> <math>v_D = v = 2 \text{ m/s}</math><br/> <math>s = 0.1 \text{ m}</math><br/> <math>W_1 = W_3 = 40 \text{ Nm}</math><br/> <math>me = \frac{2 \cdot 40}{2^2} = 20 \text{ kg}</math></p>  |
| <p><b>D Mass without propelling force with mechanical advantage</b></p> <p>Formula<br/> <math>me = \frac{2 \cdot W_3}{v_D^2}</math></p>  | <p><math>m = 20 \text{ kg}</math><br/> <math>v = 2 \text{ m/s}</math><br/> <math>v_D = 0.5 \text{ m/s}</math><br/> <math>s = 0.1 \text{ m}</math><br/> <math>W_1 = W_3 = 40 \text{ Nm}</math><br/> <math>me = \frac{2 \cdot 40}{0.5^2} = 320 \text{ kg}</math></p>   |

**Self-Compensating Shock Absorbers**

| TYPES       | Stroke<br>mm | Energy capacity<br>Nm/cycle | Effective Weight |               | Page |
|-------------|--------------|-----------------------------|------------------|---------------|------|
|             |              |                             | me min.<br>kg    | me max.<br>kg |      |
| MC5EUM-1-B  | 4            | 0.68                        | 0.5              | 4.4           | 19   |
| MC5EUM-2-B  | 4            | 0.68                        | 3.8              | 10.8          | 19   |
| MC5EUM-3-B  | 4            | 0.68                        | 9.7              | 18.7          | 19   |
| MC9EUM-1-B  | 5            | 1                           | 0.6              | 3.2           | 19   |
| MC9EUM-2-B  | 5            | 1                           | 0.8              | 4.1           | 19   |
| MC10EUMH-B  | 5            | 1.25                        | 0.7              | 5             | 19   |
| MC10EUML-B  | 5            | 1.25                        | 0.3              | 2.7           | 19   |
| MC25EUM     | 6            | 2.8                         | 1.8              | 5.4           | 19   |
| MC25EUMH    | 6            | 2.8                         | 4.6              | 13.6          | 19   |
| MC25EUML    | 6            | 2.8                         | 0.7              | 2.2           | 19   |
| MC30EUM-1   | 8            | 3.5                         | 0.4              | 1.9           | 19   |
| MC30EUM-2   | 8            | 3.5                         | 1.8              | 5.4           | 19   |
| MC30EUM-3   | 8            | 3.5                         | 5                | 15            | 19   |
| MC75EUM-1   | 10           | 9                           | 0.3              | 1.1           | 19   |
| MC75EUM-2   | 10           | 9                           | 0.9              | 4.8           | 19   |
| MC75EUM-3   | 10           | 9                           | 2.7              | 36.2          | 19   |
| MC75EUM-4   | 10           | 9                           | 25               | 72            | 19   |
| MC150EUM    | 12           | 20                          | 0.9              | 10            | 21   |
| MC150EUMH   | 12           | 20                          | 8.6              | 86            | 21   |
| MC150EUMH2  | 12           | 20                          | 70.0             | 200           | 21   |
| MC150EUMH3  | 12           | 20                          | 181.0            | 408           | 21   |
| MC225EUM    | 12           | 41                          | 2.3              | 25            | 21   |
| MC225EUMH   | 12           | 41                          | 23.0             | 230           | 21   |
| MC225EUMH2  | 12           | 41                          | 180.0            | 910           | 21   |
| MC225EUMH3  | 12           | 41                          | 816.0            | 1,814         | 21   |
| MC600EUM    | 25           | 136                         | 9.0              | 136           | 21   |
| MC600EUMH   | 25           | 136                         | 113.0            | 1,130         | 21   |
| MC600EUMH2  | 25           | 136                         | 400.0            | 2,300         | 21   |
| MC600EUMH3  | 25           | 136                         | 2,177.0          | 4,536         | 21   |
| SC25EUM-5   | 8            | 10                          | 1                | 5             | 31   |
| SC25EUM-6   | 8            | 10                          | 4                | 44            | 31   |
| SC25EUM-7   | 8            | 10                          | 42               | 500           | 31   |
| SC75EUM-5   | 10           | 16                          | 1                | 8             | 31   |
| SC75EUM-6   | 10           | 16                          | 7                | 78            | 31   |
| SC75EUM-7   | 10           | 16                          | 75               | 800           | 31   |
| SC190EUM-5  | 12           | 31                          | 2                | 16            | 31   |
| SC190EUM-6  | 12           | 31                          | 13               | 140           | 31   |
| SC190EUM-7  | 12           | 31                          | 136              | 1,550         | 31   |
| SC300EUM-5  | 15           | 73                          | 11               | 45            | 33   |
| SC300EUM-6  | 15           | 73                          | 34               | 136           | 33   |
| SC300EUM-7  | 15           | 73                          | 91               | 181           | 33   |
| SC300EUM-8  | 15           | 73                          | 135              | 680           | 33   |
| SC300EUM-9  | 15           | 73                          | 320              | 1,950         | 33   |
| SC650EUM-5  | 23           | 210                         | 23               | 113           | 33   |
| SC650EUM-6  | 23           | 210                         | 90               | 360           | 33   |
| SC650EUM-7  | 23           | 210                         | 320              | 1,090         | 33   |
| SC650EUM-8  | 23           | 210                         | 770              | 2,630         | 33   |
| SC650EUM-9  | 23           | 210                         | 1,800            | 6,350         | 33   |
| MC3325EUM-0 | 23.2         | 170                         | 3                | 11            | 53   |
| MC3325EUM-1 | 23.2         | 170                         | 9                | 40            | 53   |
| MC3325EUM-2 | 23.2         | 170                         | 30               | 120           | 53   |
| MC3325EUM-3 | 23.2         | 170                         | 100              | 420           | 53   |
| MC3325EUM-4 | 23.2         | 170                         | 350              | 1,420         | 53   |
| MC3350EUM-0 | 48.6         | 330                         | 5                | 22            | 53   |
| MC3350EUM-1 | 48.6         | 330                         | 18               | 70            | 53   |
| MC3350EUM-2 | 48.6         | 330                         | 60               | 250           | 53   |
| MC3350EUM-3 | 48.6         | 330                         | 210              | 840           | 53   |
| MC3350EUM-4 | 48.6         | 330                         | 710              | 2,830         | 53   |
| MC4525EUM-0 | 23.1         | 370                         | 7                | 27            | 54   |
| MC4525EUM-1 | 23.1         | 370                         | 20               | 90            | 54   |
| MC4525EUM-2 | 23.1         | 370                         | 80               | 310           | 54   |
| MC4525EUM-3 | 23.1         | 370                         | 260              | 1,050         | 54   |
| MC4525EUM-4 | 23.1         | 370                         | 890              | 3,540         | 54   |
| MC4550EUM-0 | 48.5         | 740                         | 13               | 54            | 54   |
| MC4550EUM-1 | 48.5         | 740                         | 45               | 180           | 54   |
| MC4550EUM-2 | 48.5         | 740                         | 150              | 620           | 54   |
| MC4550EUM-3 | 48.5         | 740                         | 520              | 2,090         | 54   |
| MC4550EUM-4 | 48.5         | 740                         | 1,800            | 7,100         | 54   |
| MC4575EUM-0 | 73.9         | 1,130                       | 20               | 80            | 54   |
| MC4575EUM-1 | 73.9         | 1,130                       | 70               | 270           | 54   |
| MC4575EUM-2 | 73.9         | 1,130                       | 230              | 930           | 54   |
| MC4575EUM-3 | 73.9         | 1,130                       | 790              | 3,140         | 54   |

**Self-Compensating Shock Absorbers**

| TYPES        | Stroke<br>mm | Energy capacity<br>Nm/cycle | Effective Weight |               | Page |
|--------------|--------------|-----------------------------|------------------|---------------|------|
|              |              |                             | me min.<br>kg    | me max.<br>kg |      |
| MC4575EUM-4  | 73.9         | 1,130                       | 2,650            | 10,600        | 54   |
| MC6450EUM-0  | 48.6         | 1,870                       | 35               | 140           | 55   |
| MC6450EUM-1  | 48.6         | 1,870                       | 140              | 540           | 55   |
| MC6450EUM-2  | 48.6         | 1,870                       | 460              | 1,850         | 55   |
| MC6450EUM-3  | 48.6         | 1,870                       | 1,600            | 6,300         | 55   |
| MC6450EUM-4  | 48.6         | 1,870                       | 5,300            | 21,200        | 55   |
| MC64100EUM-0 | 99.4         | 3,730                       | 70               | 280           | 55   |
| MC64100EUM-1 | 99.4         | 3,730                       | 270              | 1,100         | 55   |
| MC64100EUM-2 | 99.4         | 3,730                       | 930              | 3,700         | 55   |
| MC64100EUM-3 | 99.4         | 3,730                       | 3,150            | 12,600        | 55   |
| MC64100EUM-4 | 99.4         | 3,730                       | 10,600           | 42,500        | 55   |
| MC64150EUM-0 | 150          | 5,650                       | 100              | 460           | 55   |
| MC64150EUM-1 | 150          | 5,650                       | 410              | 1,640         | 55   |
| MC64150EUM-2 | 150          | 5,650                       | 1,390            | 5,600         | 55   |
| MC64150EUM-3 | 150          | 5,650                       | 4,700            | 18,800        | 55   |
| MC64150EUM-4 | 150          | 5,650                       | 16,000           | 63,700        | 55   |
| SC3325EUM-5  | 23.2         | 155                         | 1,360            | 2,721         | 69   |
| SC3325EUM-6  | 23.2         | 155                         | 2,500            | 5,443         | 69   |
| SC3325EUM-7  | 23.2         | 155                         | 4,989            | 8,935         | 69   |
| SC3325EUM-8  | 23.2         | 155                         | 8,618            | 13,607        | 69   |
| SC3350EUM-5  | 48.6         | 310                         | 2,721            | 4,990         | 69   |
| SC3350EUM-6  | 48.6         | 310                         | 4,536            | 9,980         | 69   |
| SC4525EUM-5  | 23.1         | 340                         | 3,400            | 6,800         | 69   |
| SC4525EUM-6  | 23.1         | 340                         | 6,350            | 13,600        | 69   |
| SC4525EUM-7  | 23.1         | 340                         | 12,700           | 22,679        | 69   |
| SC4525EUM-8  | 23.1         | 340                         | 20,411           | 39,000        | 69   |
| SC4550EUM-5  | 48.5         | 680                         | 6,800            | 12,246        | 69   |
| SC4550EUM-6  | 48.5         | 680                         | 11,790           | 26,988        | 69   |
| SC4550EUM-7  | 48.5         | 680                         | 25,854           | 44,225        | 69   |
| CA2X2EU-1    | 50           | 3,600                       | 700              | 2,200         | 83   |
| CA2X2EU-2    | 50           | 3,600                       | 1,800            | 5,400         | 83   |
| CA2X2EU-3    | 50           | 3,600                       | 4,500            | 13,000        | 83   |
| CA2X2EU-4    | 50           | 3,600                       | 11,300           | 34,000        | 83   |
| CA2X4EU-1    | 102          | 7,200                       | 1,400            | 4,400         | 83   |
| CA2X4EU-2    | 102          | 7,200                       | 3,600            | 11,000        | 83   |
| CA2X4EU-3    | 102          | 7,200                       | 9,100            | 27,200        | 83   |
| CA2X4EU-4    | 102          | 7,200                       | 22,600           | 68,000        | 83   |
| CA2X6EU-1    | 152          | 10,800                      | 2,200            | 6,500         | 83   |
| CA2X6EU-2    | 152          | 10,800                      | 5,400            | 16,300        | 83   |
| CA2X6EU-3    | 152          | 10,800                      | 13,600           | 40,800        | 83   |
| CA2X6EU-4    | 152          | 10,800                      | 34,000           | 102,000       | 83   |
| CA2X8EU-1    | 203          | 14,500                      | 2,900            | 8,700         | 83   |
| CA2X8EU-2    | 203          | 14,500                      | 7,200            | 21,700        | 83   |
| CA2X8EU-3    | 203          | 14,500                      | 18,100           | 54,400        | 83   |
| CA2X8EU-4    | 203          | 14,500                      | 45,300           | 136,000       | 83   |
| CA2X10EU-1   | 254          | 18,000                      | 3,600            | 11,000        | 83   |
| CA2X10EU-2   | 254          | 18,000                      | 9,100            | 27,200        | 83   |
| CA2X10EU-3   | 254          | 18,000                      | 22,600           | 68,000        | 83   |
| CA2X10EU-4   | 254          | 18,000                      | 56,600           | 170,000       | 83   |
| CA3X5EU-1    | 127          | 14,125                      | 2,900            | 8,700         | 84   |
| CA3X5EU-2    | 127          | 14,125                      | 7,250            | 21,700        | 84   |
| CA3X5EU-3    | 127          | 14,125                      | 18,100           | 54,350        | 84   |
| CA3X5EU-4    | 127          | 14,125                      | 45,300           | 135,900       | 84   |
| CA3X8EU-1    | 203          | 22,600                      | 4,650            | 13,900        | 84   |
| CA3X8EU-2    | 203          | 22,600                      | 11,600           | 34,800        | 84   |
| CA3X8EU-3    | 203          | 22,600                      | 29,000           | 87,000        | 84   |
| CA3X8EU-4    | 203          | 22,600                      | 72,500           | 217,000       | 84   |
| CA3X12EU-1   | 305          | 33,900                      | 6,950            | 20,900        | 84   |
| CA3X12EU-2   | 305          | 33,900                      | 17,400           | 52,200        | 84   |
| CA3X12EU-3   | 305          | 33,900                      | 43,500           | 130,450       | 84   |
| CA3X12EU-4   | 305          | 33,900                      | 108,700          | 326,000       | 84   |
| CA4X6EU-3    | 152          | 47,500                      | 3,500            | 8,600         | 85   |
| CA4X6EU-5    | 152          | 47,500                      | 8,600            | 18,600        | 85   |
| CA4X6EU-7    | 152          | 47,500                      | 18,600           | 42,700        | 85   |
| CA4X8EU-3    | 203          | 63,300                      | 5,000            | 11,400        | 85   |
| CA4X8EU-5    | 203          | 63,300                      | 11,400           | 25,000        | 85   |
| CA4X8EU-7    | 203          | 63,300                      | 25,000           | 57,000        | 85   |
| CA4X16EU-3   | 406          | 126,500                     | 10,000           | 23,000        | 85   |
| CA4X16EU-5   | 406          | 126,500                     | 23,000           | 50,000        | 85   |
| CA4X16EU-7   | 406          | 126,500                     | 50,000           | 115,000       | 85   |



**Shock Absorbers soft contact and self-compensating**

| TYPES      | Stroke<br>mm | Energy<br>capacity<br>Nm/cycle | Effective Weight |               |                   |               | Page |
|------------|--------------|--------------------------------|------------------|---------------|-------------------|---------------|------|
|            |              |                                | Soft-Contact     |               | Self-Compensating |               |      |
|            |              |                                | me min.<br>kg    | me max.<br>kg | me min.<br>kg     | me max.<br>kg |      |
| SC190EUM-0 | 16           | 25                             | -                | -             | 0.7               | 4             | 29   |
| SC190EUM-1 | 16           | 25                             | 2.3              | 6             | 1.4               | 7             | 29   |
| SC190EUM-2 | 16           | 25                             | 5.5              | 16            | 3.6               | 18            | 29   |
| SC190EUM-3 | 16           | 25                             | 14               | 41            | 9.0               | 45            | 29   |
| SC190EUM-4 | 16           | 25                             | 34               | 91            | 23.0              | 102           | 29   |
| SC300EUM-0 | 19           | 33                             | -                | -             | 0.7               | 4             | 29   |
| SC300EUM-1 | 19           | 33                             | 2.3              | 7             | 1.4               | 8             | 29   |
| SC300EUM-2 | 19           | 33                             | 7                | 23            | 4.5               | 27            | 29   |
| SC300EUM-3 | 19           | 33                             | 23               | 68            | 14.0              | 82            | 29   |
| SC300EUM-4 | 19           | 33                             | 68               | 181           | 32.0              | 204           | 29   |
| SC650EUM-0 | 25.4         | 73                             | -                | -             | 2.3               | 14            | 29   |
| SC650EUM-1 | 25.4         | 73                             | 11               | 36            | 8.0               | 45            | 29   |
| SC650EUM-2 | 25.4         | 73                             | 34               | 113           | 23.0              | 136           | 29   |
| SC650EUM-3 | 25.4         | 73                             | 109              | 363           | 68.0              | 408           | 29   |
| SC650EUM-4 | 25.4         | 73                             | 363              | 1,089         | 204.0             | 1,180         | 29   |
| SC925EUM-0 | 40           | 110                            | 8                | 25            | 4.5               | 29            | 29   |
| SC925EUM-1 | 40           | 110                            | 22               | 72            | 14.0              | 90            | 29   |
| SC925EUM-2 | 40           | 110                            | 59               | 208           | 40.0              | 227           | 29   |
| SC925EUM-3 | 40           | 110                            | 181              | 612           | 113.0             | 726           | 29   |
| SC925EUM-4 | 40           | 110                            | 544              | 1,952         | 340.0             | 2,088         | 29   |

**Adjustable Shock Absorbers**

| TYPES      | Stroke<br>mm | Max. Energy Capacity       |                        | Effective Weight |               | Page |
|------------|--------------|----------------------------|------------------------|------------------|---------------|------|
|            |              | W <sub>3</sub><br>Nm/cycle | W <sub>4</sub><br>Nm/h | me min.<br>kg    | me max.<br>kg |      |
|            |              | MA30EUM                    | 8                      | 3.5              | 5,650         |      |
| MA50EUM-B  | 7.2          | 5.5                        | 13,550                 | 4.50             | 20            | 35   |
| MA35EUM    | 10.2         | 4.0                        | 6,000                  | 6.00             | 57            | 35   |
| MA150EUM   | 12.7         | 22.0                       | 35,000                 | 1.00             | 109           | 35   |
| MA225EUM   | 19           | 25.0                       | 45,000                 | 2.30             | 226           | 35   |
| MA600EUM   | 25           | 68.0                       | 68,000                 | 9.00             | 1,360         | 35   |
| MA900EUM   | 40           | 100.0                      | 90,000                 | 14.00            | 2,040         | 35   |
| MA3325EUM  | 23.2         | 170                        | 75,000                 | 9                | 1,700         | 71   |
| ML3325EUM  | 23.2         | 170                        | 75,000                 | 300              | 50,000        | 71   |
| MA3350EUM  | 48.6         | 340                        | 85,000                 | 13               | 2,500         | 71   |
| ML3350EUM  | 48.6         | 340                        | 85,000                 | 500              | 80,000        | 71   |
| MA4525EUM  | 23.1         | 425                        | 107,000                | 40               | 10,000        | 72   |
| ML4525EUM  | 23.1         | 425                        | 107,000                | 3,000            | 110,000       | 72   |
| MA4550EUM  | 48.5         | 850                        | 112,000                | 70               | 14,500        | 72   |
| ML4550EUM  | 48.5         | 850                        | 112,000                | 5,000            | 180,000       | 72   |
| MA4575EUM  | 73.9         | 1,300                      | 146,000                | 70               | 15,000        | 72   |
| ML6425EUM  | 23.2         | 1,135                      | 124,000                | 7,000            | 300,000       | 73   |
| MA6450EUM  | 48.6         | 2,275                      | 146,000                | 220              | 50,000        | 73   |
| ML6450EUM  | 48.6         | 2,275                      | 146,000                | 11,000           | 500,000       | 73   |
| MA64100EUM | 99.4         | 4,520                      | 192,000                | 270              | 52,000        | 73   |
| MA64150EUM | 150          | 6,780                      | 248,000                | 330              | 80,000        | 73   |
| A1½X2EU    | 50           | 2,350                      | 362,000                | 195              | 32,000        | 87   |
| A1½X3½EU   | 89           | 4,150                      | 633,000                | 218              | 36,000        | 87   |
| A1½X5EU    | 127          | 5,900                      | 904,000                | 227              | 41,000        | 87   |
| A1½X6½EU   | 165          | 7,700                      | 1,180,000              | 308              | 45,000        | 87   |
| A2X2EU     | 50           | 3,600                      | 1,100,000              | 250              | 77,000        | 88   |
| A2X4EU     | 102          | 9,000                      | 1,350,000              | 250              | 82,000        | 88   |
| A2X6EU     | 152          | 13,500                     | 1,600,000              | 260              | 86,000        | 88   |
| A2X8EU     | 203          | 19,200                     | 1,900,000              | 260              | 90,000        | 88   |
| A2X10EU    | 254          | 23,700                     | 2,200,000              | 320              | 113,000       | 88   |
| A3X5EU     | 127          | 15,800                     | 2,260,000              | 480              | 154,000       | 89   |
| A3X8EU     | 203          | 28,200                     | 3,600,000              | 540              | 181,500       | 89   |
| A3X12EU    | 305          | 44,000                     | 5,400,000              | 610              | 204,000       | 89   |

# Miniature Shock Absorbers

## Tuning for almost any design

**Miniature shock absorbers from ACE are tried-and-tested quality products used in millions of industrial construction designs throughout the world. They optimise machines in an equally reliable and effective way by decelerating loads quickly and without recoil.**

The compact, maintenance-free, hydraulic machine elements can be easily and quickly integrated in any construction design and certain models can be directly integrated in pneumatic cylinders. They reduce the load on handling devices, rotary and pivoting actuators, linear cylinders and many other industrial applications and increase their efficiency. Innovative ACE sealing techniques and shock absorber bodies and inner pressure chambers, fully machined from solid high tensile alloy, tube-shaped steel, ensure a long service life.

Easy, inexpensive constructions

Large variety of models for every purpose

Less stress on the machine

Reduced operating costs

Maintenance-free



## Miniature Shock Absorbers



### MC5 to MC75

Page 18

Self-Compensating

**Shock absorbers in miniature format**

Miniature slides, Pneumatic cylinders, Handling modules, Copiers



### MC150 to MC600

Page 20

Self-Compensating, Rolling Diaphragm Technology

**Exceptionally high endurance and with the lowest resetting force**

Linear slides, Pneumatic cylinders, Swivel units, Handling modules



### MC150-V4A to MC600-V4A

Page 22

Self-Compensating, Stainless Steel, Rolling Diaphragm Technology

**Exceptionally high endurance with stainless steel corrosion protection**

Clean room areas, Pharmaceutical industry, Medical technology, Food industry



### PMCN150 to PMCN600

Page 24

Self-Compensating, Rolling Diaphragm Technology, TPU Bellow

**Reliable protection against fluids**

Finishing and processing centres, Clean room areas, Pharmaceutical industry, Medical technology



### PMCN150-V4A to PMCN600-V4A

Page 26

Self-Compensating, Rolling Diaphragm Technology, TPU Bellow

**Optimum corrosion protection**

Finishing and processing centres, Clean room areas, Pharmaceutical industry, Medical technology



### SC190 to SC925

Page 28

Self-Compensating, Soft-Contact

**Long stroke and soft impact**

Linear slides, Pneumatic cylinders, Handling modules, Machines and plants



### SC<sup>2</sup>25 to SC<sup>2</sup>190

Page 30

Self-Compensating, Piston Tube Technology

**Piston tube design for maximum energy absorption**

Linear slides, Pneumatic cylinders, Swivel units, Handling modules



### SC<sup>2</sup>300 to SC<sup>2</sup>650

Page 32

Self-Compensating, Piston Tube Technology

**Piston tube design for maximum energy absorption**

Turntables, Swivel units, Robot arms, Linear slides



### MA30 to MA900

Page 34

Adjustable

**Stepless adjustment**

Linear slides, Pneumatic cylinders, Swivel units, Handling modules

## MC5 to MC75

### Shock absorbers in miniature format

#### Self-Compensating

**Energy capacity 0.68 Nm/Cycle to 9 Nm/Cycle**

**Stroke 4 mm to 10 mm**

Ideal for compact, efficient designs: The MC5 to MC75 series impresses users with their reduced dimensions and their very short overall lengths and low resetting forces after braking.

The outer body of each damper, produced from one solid piece, are filled with temperature stable oil, offer a continuous thread incl. a supplied lock nut and also have an integrated positive stop. These hydraulic machine elements from ACE, are ready for immediate installation and are maintenance-free. A comprehensive range of energy absorption with a wide range of effective weight potential are further benefits in these miniature units.

These miniature shock absorbers are perfectly suited to use in applications such as mechanical engineering, medical and electro-technology and robotics.

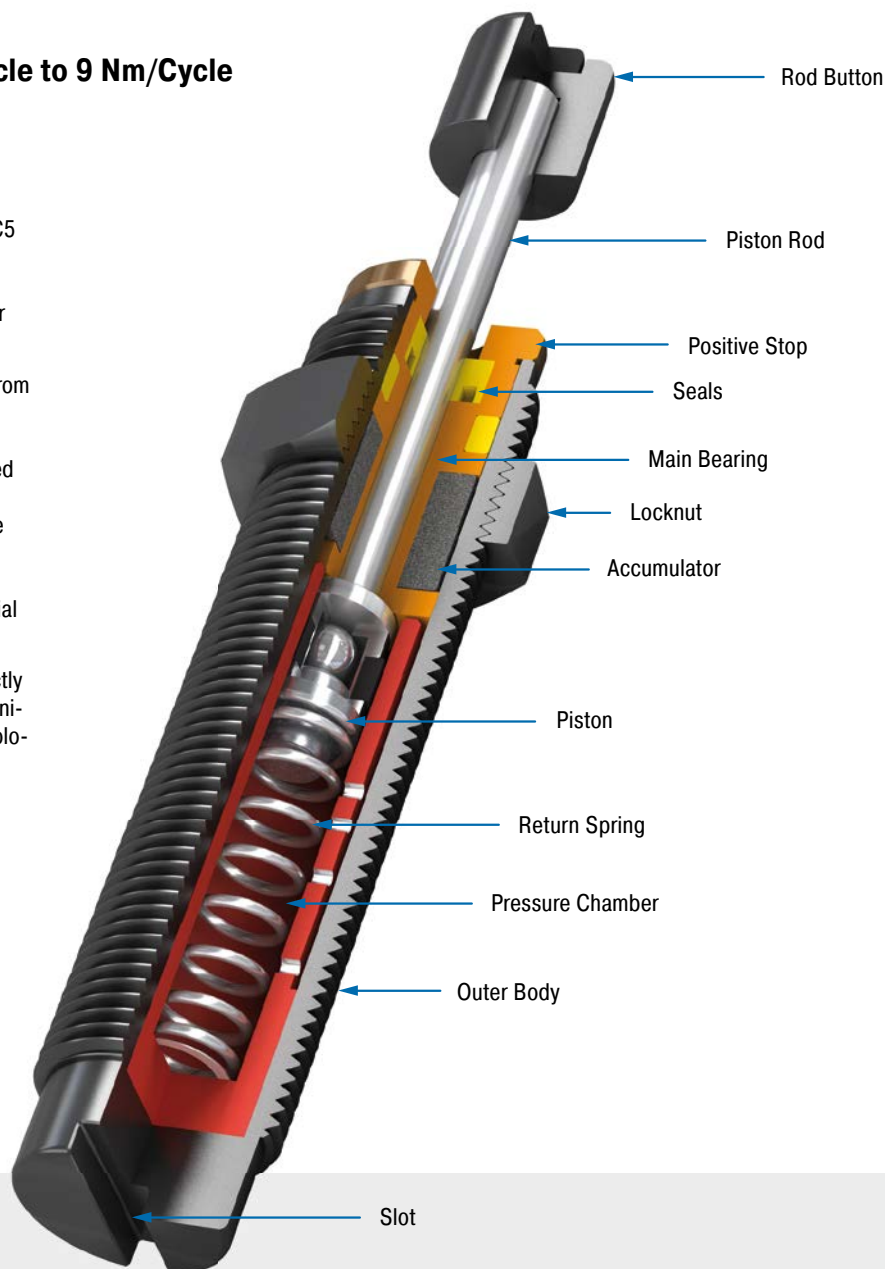

#### Technical Data

**Energy capacity:** 0.68 Nm/Cycle to 9 Nm/Cycle

**Impact velocity range:** 0.15 m/s to 4 m/s

**Operating temperature range:** -10 °C to +66 °C

**Mounting:** In any position

**Positive stop:** Integrated

**Material:** Outer body, Accessories: Steel corrosion-resistant coating; Piston rod: hardened stainless steel; Rod end button: Steel, MC25 and MC75: Elastomer Insert; Locknut: Steel, MC5 and MC9: Aluminium

**Damping medium:** Oil, temperature stable

**Application field:** Miniature slides, Pneumatic cylinders, Handling modules, Copiers, Measuring tables, Machines and plants, Locking systems

**Note:** If precise end position datum is required consider use of the stop collar type AH.

**Safety instructions:** External materials in the surrounding area can attack the seal components and lead to a shorter service life. Please contact ACE for appropriate solution suggestions. Do not paint the shock absorbers due to heat emission.

**On request:** Increased corrosion protection. Special finishes. Models without rod end button also available on request.

Self-Compensating

### MC5EUM

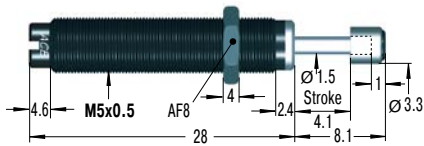

### MB5SC2

Mounting Block

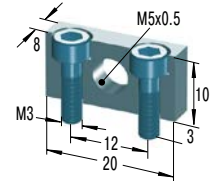

### MC9EUM

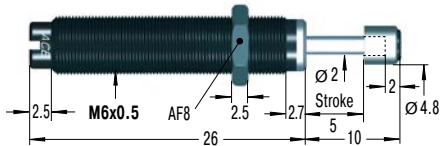

### RF6

Rectangular Flange

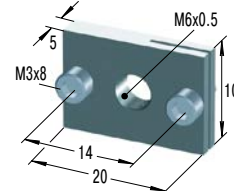

### MB6SC2

Mounting Block

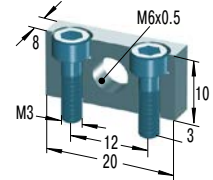

### MC30EUM for use on new installations

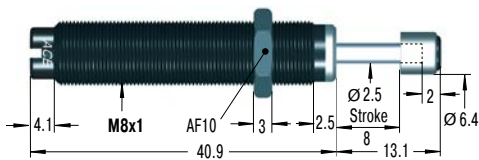

### MC10EUM still available in future

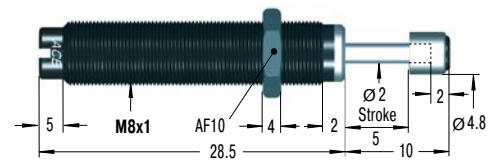

M8x0.75 also available to order

### MC25EUM

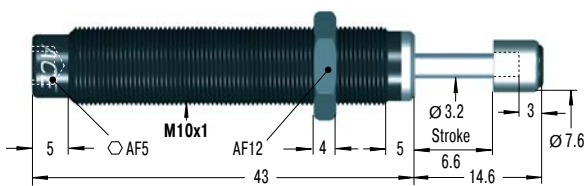

### RF10

Rectangular Flange

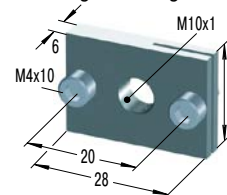

### MB10SC2

Mounting Block

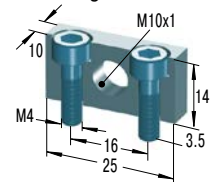

### MC75EUM

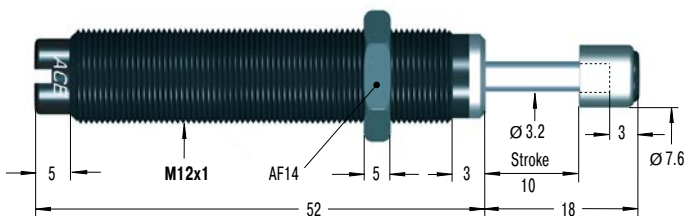

### RF12

Rectangular Flange

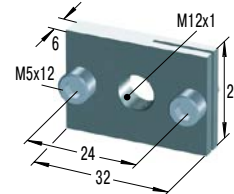

### MB12

Clamp Mount

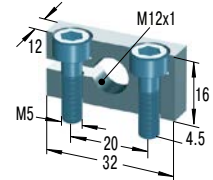

Additional accessories, mounting, installation ... see from page 36.

### Performance

| TYPES       | Max. Energy Capacity    |                     | Effective Weight |            | Return Force min. | Return Force max. | Return Time s | Side Load Angle max. ° | Weight kg |
|-------------|-------------------------|---------------------|------------------|------------|-------------------|-------------------|---------------|------------------------|-----------|
|             | W <sub>3</sub> Nm/cycle | W <sub>4</sub> Nm/h | me min. kg       | me max. kg |                   |                   |               |                        |           |
| MC5EUM-1-B  | 0.68                    | 2,040               | 0.5              | 4.4        | 1                 | 5                 | 0.2           | 2                      | 0.003     |
| MC5EUM-2-B  | 0.68                    | 2,040               | 3.8              | 10.8       | 1                 | 5                 | 0.2           | 2                      | 0.003     |
| MC5EUM-3-B  | 0.68                    | 2,040               | 9.7              | 18.7       | 1                 | 5                 | 0.2           | 2                      | 0.003     |
| MC9EUM-1-B  | 1                       | 2,000               | 0.6              | 3.2        | 2                 | 4                 | 0.3           | 2                      | 0.004     |
| MC9EUM-2-B  | 1                       | 2,000               | 0.8              | 4.1        | 2                 | 4                 | 0.3           | 2                      | 0.004     |
| MC10EUM-L-B | 1.25                    | 4,000               | 0.3              | 2.7        | 2                 | 4                 | 0.6           | 3                      | 0.007     |
| MC10EUM-H-B | 1.25                    | 4,000               | 0.7              | 5          | 2                 | 4                 | 0.6           | 3                      | 0.007     |
| MC25EUM-L   | 2.8                     | 22,600              | 0.7              | 2.2        | 3                 | 6                 | 0.3           | 2                      | 0.020     |
| MC25EUM     | 2.8                     | 22,600              | 1.8              | 5.4        | 3                 | 6                 | 0.3           | 2                      | 0.020     |
| MC25EUM-H   | 2.8                     | 22,600              | 4.6              | 13.6       | 3                 | 6                 | 0.3           | 2                      | 0.020     |
| MC30EUM-1   | 3.5                     | 5,600               | 0.4              | 1.9        | 2                 | 6                 | 0.3           | 2                      | 0.010     |
| MC30EUM-2   | 3.5                     | 5,600               | 1.8              | 5.4        | 2                 | 6                 | 0.3           | 2                      | 0.010     |
| MC30EUM-3   | 3.5                     | 5,600               | 5                | 15         | 2                 | 6                 | 0.3           | 2                      | 0.010     |
| MC75EUM-1   | 9                       | 28,200              | 0.3              | 1.1        | 4                 | 9                 | 0.3           | 2                      | 0.035     |
| MC75EUM-2   | 9                       | 28,200              | 0.9              | 4.8        | 4                 | 9                 | 0.3           | 2                      | 0.035     |
| MC75EUM-3   | 9                       | 28,200              | 2.7              | 36.2       | 4                 | 9                 | 0.3           | 2                      | 0.035     |
| MC75EUM-4   | 9                       | 28,200              | 25               | 72         | 4                 | 9                 | 0.3           | 2                      | 0.035     |

<sup>1</sup> For applications with higher side load angles consider using the side load adaptor (BV) pages 38 to 45.



## MC150 to MC600

Exceptionally high endurance and with the lowest resetting force

### Self-Compensating, Rolling Diaphragm Technology

Energy capacity 20 Nm/Cycle to 136 Nm/Cycle

Stroke 12 mm bis 25 mm

Tried-and-tested and durable: Due to a hermetically sealed rolling diaphragm in each absorber, the MC150 to MC600 product family is suitable for an exceptional high lifetime of use with up to 25 million cycles. The rolling diaphragm technology perfected by ACE ensures complete separation of the damping fluid from the surrounding air. This makes direct installation in a pressure chamber e.g. as end stop damping in pneumatic cylinders up to approx. 7 bar possible.

The rolling diaphragm also benefits the very low return forces of these maintenance-free, ready-to-install absorbers. Progressive energy capacities, with a wide range of effective weight potential make these miniature shock absorbers, complete with an integrated positive stop a winner. Furthermore, the use of a side load adapter allows impact angles of up to 25°.

Miniature shock absorbers capable of universal mounting even inside a cylinder and also available in stainless steel options. They are often used in mechanical and plant engineering, and a multitude of other applications.

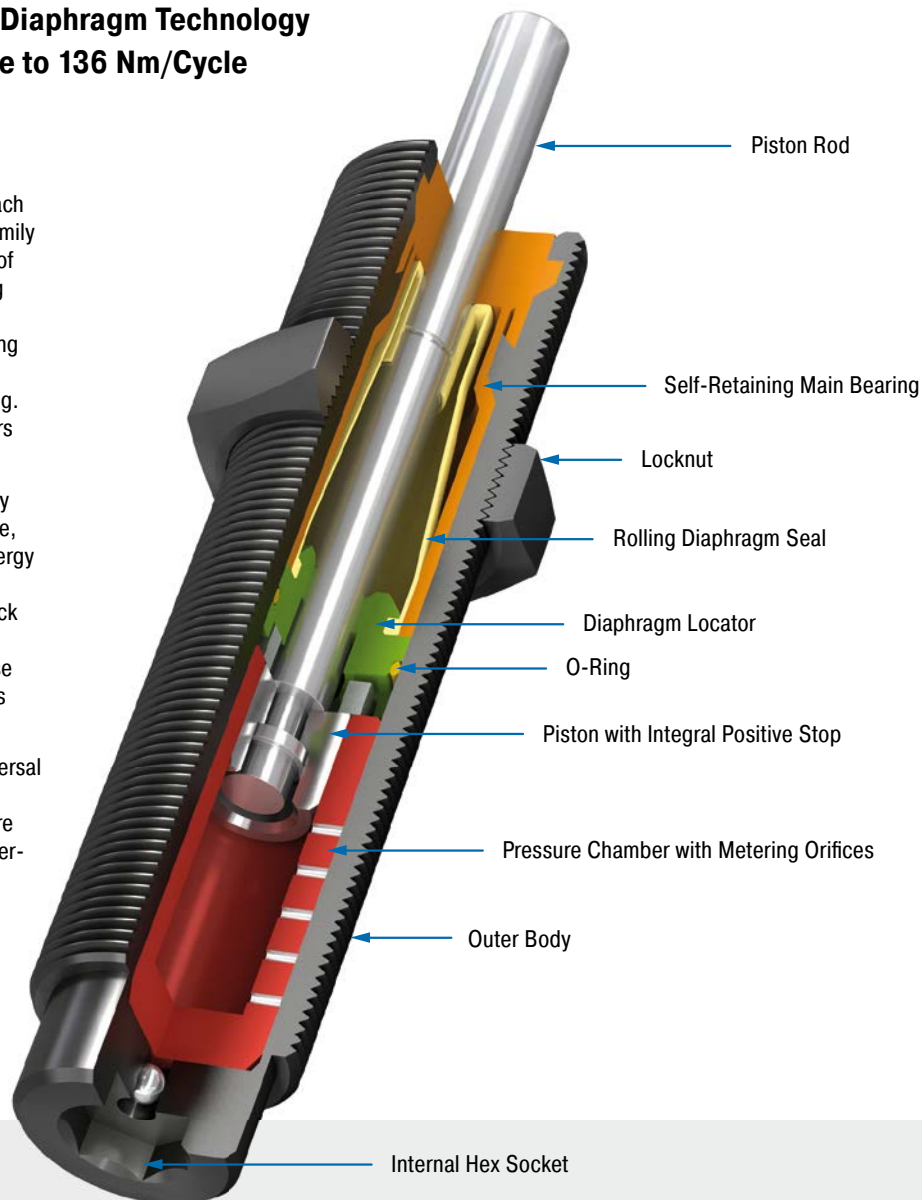

### Technical Data

**Energy capacity:** 20 Nm/Cycle to 136 Nm/Cycle

**Impact velocity range:** 0.06 m/s to 6 m/s.  
Other speeds on request.

**Operating temperature range:** 0 °C to 66 °C

**Mounting:** in any position

**Positive stop:** Integrated

**Material:** Outer body, Accessories: steel corrosion-resistant coating; Main bearing: plastic; Piston rod: hardened stainless steel (1.4125, AISI 440C); Rolling diaphragm: EPDM

**Damping medium:** oil, temperature stable

**Application field:** linear slides, pneumatic cylinders, swivel units, handling modules,

machines and plants, finishing and processing centres, measuring tables, tool machines, locking systems

**Note:** If precise end position datum is required consider use of the stop collar type AH.

**Safety instructions:** External materials in the surrounding area can attack the rolling seal and lead to a shorter service life. Please contact ACE for appropriate solution suggestions. Suitable for use in pressure chambers up to 7 bar.

**On request:** Increased corrosion protection. Special threads or other special options.

### MC150EUM

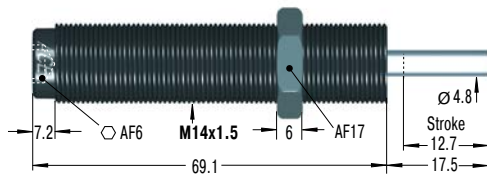

M14x1 also available to special order

### PP150 Nylon Button

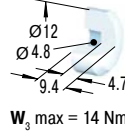

### RF14 Rectangular Flange

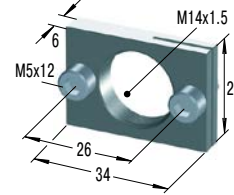

### MB14 Clamp Mount

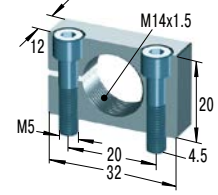

### MC225EUM

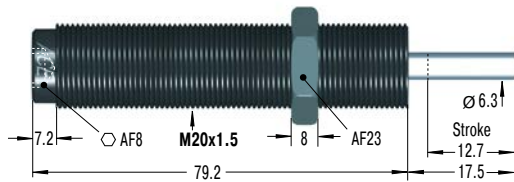

### PP225 Nylon Button

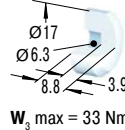

### RF20 Rectangular Flange

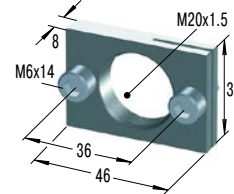

### MB20 Clamp Mount

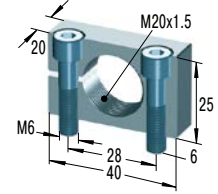

### MC600EUM

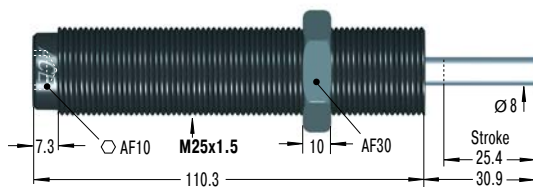

M27x3 also available to special order

### PP600 Nylon Button

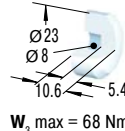

### RF25 Rectangular Flange

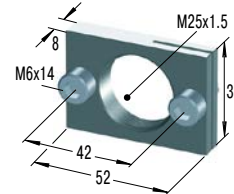

### MB25 Clamp Mount

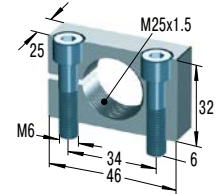

Additional accessories, mounting, installation ... see from page 36.

### Performance

| TYPES      | Max. Energy Capacity       |                        | Effective Weight |               | Return Force<br>min.<br>N | Return Force<br>max.<br>N | Return Time<br>s | ¹ Side Load Angle<br>max.<br>° | Weight<br>kg |
|------------|----------------------------|------------------------|------------------|---------------|---------------------------|---------------------------|------------------|--------------------------------|--------------|
|            | W <sub>3</sub><br>Nm/cycle | W <sub>4</sub><br>Nm/h | me min.<br>kg    | me max.<br>kg |                           |                           |                  |                                |              |
| MC150EUM   | 20                         | 34,000                 | 0.9              | 10            | 3                         | 8                         | 0.4              | 4                              | 0.06         |
| MC150EUMH  | 20                         | 34,000                 | 8.6              | 86            | 3                         | 8                         | 0.4              | 4                              | 0.06         |
| MC150EUMH2 | 20                         | 34,000                 | 70.0             | 200           | 3                         | 8                         | 0.4              | 4                              | 0.06         |
| MC150EUMH3 | 20                         | 34,000                 | 181.0            | 408           | 3                         | 8                         | 1.0              | 4                              | 0.06         |
| MC225EUM   | 41                         | 45,000                 | 2.3              | 25            | 4                         | 9                         | 0.3              | 4                              | 0.13         |
| MC225EUMH  | 41                         | 45,000                 | 23.0             | 230           | 4                         | 9                         | 0.3              | 4                              | 0.13         |
| MC225EUMH2 | 41                         | 45,000                 | 180.0            | 910           | 4                         | 9                         | 0.3              | 4                              | 0.13         |
| MC225EUMH3 | 41                         | 45,000                 | 816.0            | 1,814         | 4                         | 9                         | 0.3              | 4                              | 0.13         |
| MC600EUM   | 136                        | 68,000                 | 9.0              | 136           | 5                         | 10                        | 0.6              | 2                              | 0.31         |
| MC600EUMH  | 136                        | 68,000                 | 113.0            | 1,130         | 5                         | 10                        | 0.6              | 2                              | 0.31         |
| MC600EUMH2 | 136                        | 68,000                 | 400.0            | 2,300         | 5                         | 10                        | 0.6              | 2                              | 0.31         |
| MC600EUMH3 | 136                        | 68,000                 | 2,177.0          | 4,536         | 5                         | 10                        | 0.6              | 2                              | 0.31         |

¹ For applications with higher side load angles consider using the side load adaptor (BV) pages 38 to 45.



## MC150-V4A to MC600-V4A

Exceptionally high endurance with stainless steel corrosion protection

**Self-Compensating, Stainless Steel, Rolling Diaphragm Technology**

**Energy capacity 20 Nm/Cycle to 136 Nm/Cycle**

**Stroke 12 mm to 25 mm**

Brilliant in every respect: These high performance miniature shock absorbers in stainless steel are based on the MC150 to MC600 product family and its proven damping technology. This means that these special absorbers offer all of the benefits of the MC standard units such as the proven ACE rolling diaphragm technology for maximum service life and direct installation in a pressure chamber with up to approx. 7 bar.

Thanks to perfectly progressive maximum energy absorption and effective weight potential, their use is augmented even further by the outer body and a complete range of accessories made of stainless steel (material 1.4404).

Miniature shock absorbers made of stainless steel are mainly used in medical and electro-technology, but also in shipbuilding, packaging and chemicals industry and in the food processing. For the latter, they are filled with a special oil in order to fulfil the authorisation conditions (NSF-H1) for this market.

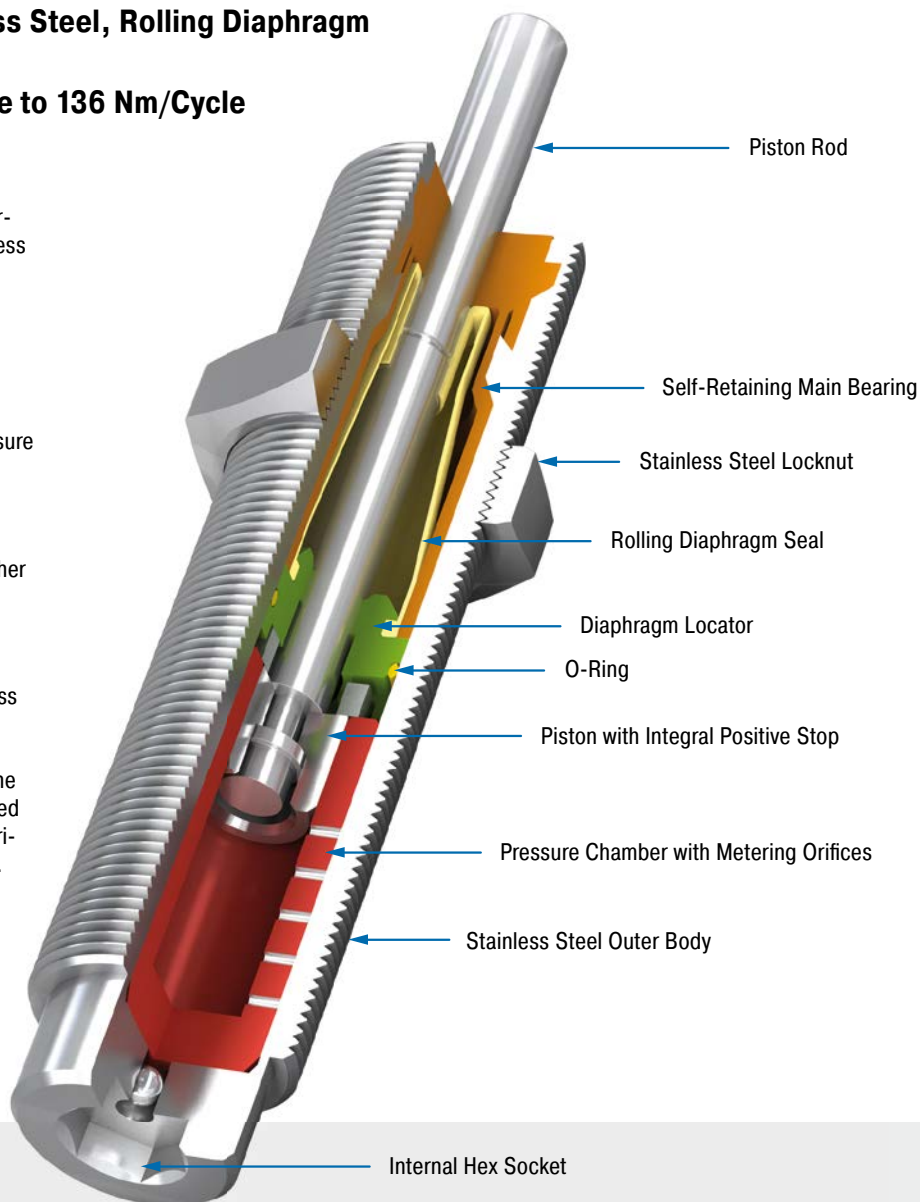

### Technical Data

**Energy capacity:** 20 Nm/Cycle to 136 Nm/Cycle

**Impact velocity range:** 0.06 m/s to 6 m/s.  
Other speeds on request.

**Operating temperature range:** 0 °C to 66 °C

**Mounting:** In any position

**Positive stop:** Integrated

**Material:** Outer body, Locknut, Accessories: Stainless steel (1.4404, AISI 316L); Main bearing: Plastic; Piston rod: Hardened stainless steel (1.4125, AISI 440C); Rolling diaphragm: EPDM

**Damping medium:** Oil, temperature stable

**Application field:** Clean room areas, Pharmaceutical industry, Medical technology, Food industry, Linear slides, Pneumatic cylinders, Handling modules, Machines and plants, Finishing and processing centres

**Note:** If precise end position datum is required consider use of the stop collar type AH.

**Safety instructions:** External materials in the surrounding area can attack the rolling seal and lead to a shorter service life. Please contact ACE for appropriate solution suggestions. Suitable for use in pressure chambers up to 7 bar.

**On request:** Special oil with food approval. Special threads or other special options available on request.

### MC150EUM-V4A

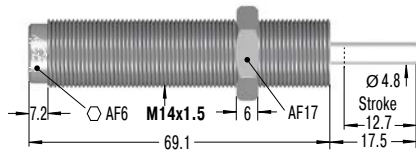

### PP150 Nylon Button

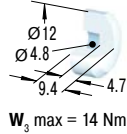

### AH14-V4A Stop Collar

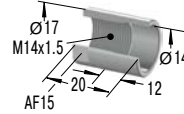

### MB14SC2-V4A Mounting Block

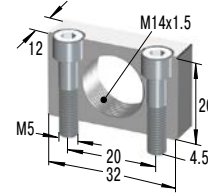

### KM14-V4A Locknut

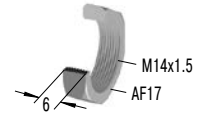

### MC225EUM-V4A

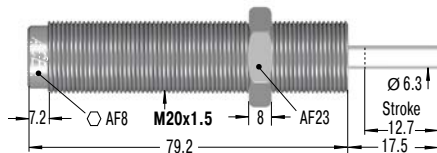

### PP225 Nylon Button

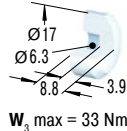

### AH20-V4A Stop Collar

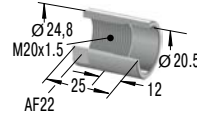

### MB20SC2-V4A Mounting Block

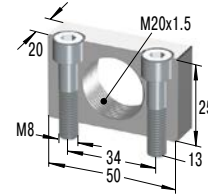

### KM20-V4A Locknut



### MC600EUM-V4A

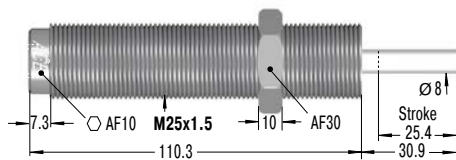

### PP600 Nylon Button

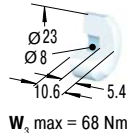

### AH25-V4A Stop Collar

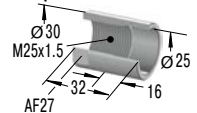

### MB25SC2-V4A Mounting Block

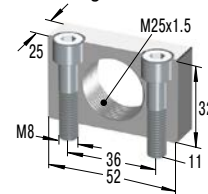

### KM25-V4A Locknut

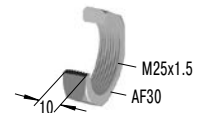

Additional accessories, mounting, installation ... see from page 36.

### Performance

| TYPES          | Max. Energy Capacity       |                        | Effective Weight |               | Return Force<br>min.<br>N | Return Force<br>max.<br>N | Return Time<br>s | Side Load Angle<br>max.<br>° | Weight<br>kg |
|----------------|----------------------------|------------------------|------------------|---------------|---------------------------|---------------------------|------------------|------------------------------|--------------|
|                | W <sub>3</sub><br>Nm/cycle | W <sub>4</sub><br>Nm/h | me min.<br>kg    | me max.<br>kg |                           |                           |                  |                              |              |
| MC150EUM-V4A   | 20                         | 34,000                 | 0.9              | 10            | 3                         | 5                         | 0.4              | 4                            | 0.06         |
| MC150EUMH-V4A  | 20                         | 34,000                 | 8.6              | 86            | 3                         | 5                         | 0.4              | 4                            | 0.06         |
| MC150EUMH2-V4A | 20                         | 34,000                 | 70.0             | 200           | 3                         | 5                         | 0.4              | 4                            | 0.06         |
| MC150EUMH3-V4A | 20                         | 34,000                 | 181.0            | 408           | 3                         | 5                         | 1.0              | 4                            | 0.06         |
| MC225EUM-V4A   | 41                         | 45,000                 | 2.3              | 25            | 4                         | 6                         | 0.3              | 4                            | 0.13         |
| MC225EUMH-V4A  | 41                         | 45,000                 | 23.0             | 230           | 4                         | 6                         | 0.3              | 4                            | 0.13         |
| MC225EUMH2-V4A | 41                         | 45,000                 | 180.0            | 910           | 4                         | 6                         | 0.3              | 4                            | 0.13         |
| MC225EUMH3-V4A | 41                         | 45,000                 | 816.0            | 1,814         | 4                         | 6                         | 0.3              | 4                            | 0.13         |
| MC600EUM-V4A   | 136                        | 68,000                 | 9.0              | 136           | 5                         | 9                         | 0.6              | 2                            | 0.31         |
| MC600EUMH-V4A  | 136                        | 68,000                 | 113.0            | 1,130         | 5                         | 9                         | 0.6              | 2                            | 0.31         |
| MC600EUMH2-V4A | 136                        | 68,000                 | 400.0            | 2,300         | 5                         | 9                         | 0.6              | 2                            | 0.31         |
| MC600EUMH3-V4A | 136                        | 68,000                 | 2,177.0          | 4,536         | 5                         | 9                         | 0.6              | 2                            | 0.31         |

<sup>1</sup> For applications with higher side load angles please contact ACE.

## PMCN150 to PMCN600

### Reliable protection against fluids

#### Self-Compensating, Rolling Diaphragm Technology, TPU Bellow

**Energy capacity 20 Nm/Cycle to 136 Nm/Cycle**  
**Stroke 12 mm to 25 mm**

Hermetically sealed: The shock absorbers from the ACE Protection series PMCN have a compact, perfectly sealed cap as a special feature.

This protection bellows, made of TPU (thermo-plastic polyurethane), safely encapsulates the proven ACE rolling diaphragm from the outside environment. Aggressive cutting, lubricating and cleaning agents don't stand a chance and the function of the maintenance-free, ready-to-install shock absorber is retained. They are also available in full stainless steel.

The PMCN series is a good alternative to the SP type air bleed collar if no compressed air is available on the machine or system.

Reliable protection against aggressive fluids, these miniature shock absorbers are the first choice everywhere where conventional dampers wear out too quickly, eg. As in machining centers or other applications of mechanical engineering.

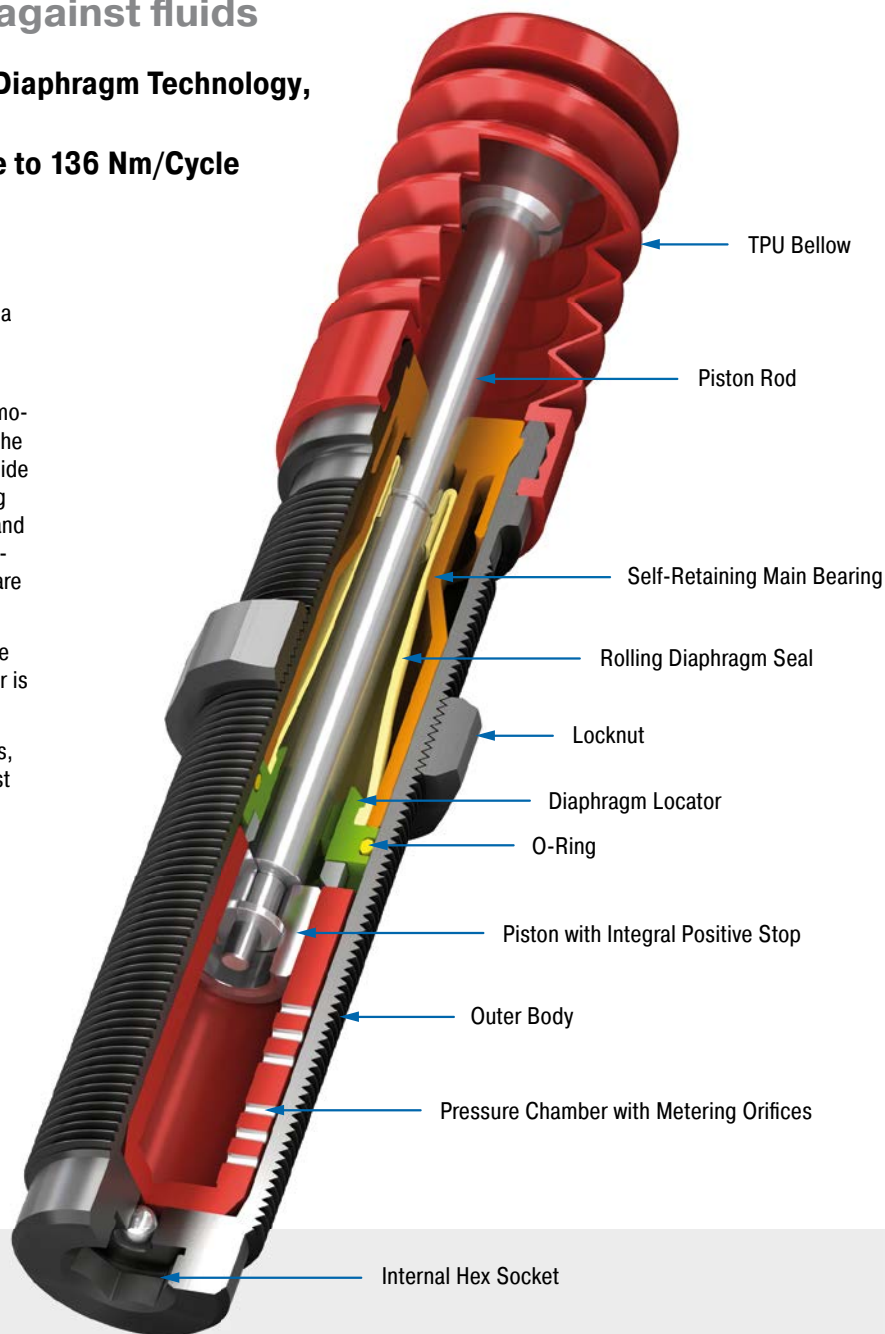

### Technical Data

**Energy capacity:** 20 Nm/Cycle to 136 Nm/Cycle

**Impact velocity range:** 0.06 m/s to 6 m/s.  
Other speeds on request.

**Operating temperature range:** 0 °C to 66 °C

**Mounting:** In any position

**Positive stop:** Integrated

**Material:** Outer body: Steel corrosion-resistant coating; Main bearing: Plastic; Piston rod: Hardened stainless steel (1.4125, AISI 440C); Bellow: TPU, steel insert: Stainless steel (1.4404/1.4571, AISI 316L/316Ti); Rolling diaphragm: EPDM

**Damping medium:** Oil, temperature stable

**Application field:** Finishing and processing centres, Clean room areas, Pharmaceutical industry, Medical technology, Food industry, Linear slides, Pneumatic cylinders, Machines and plants

**Note:** Final preliminary test must be done on the application.

**Safety instructions:** Do not paint the shock absorbers due to heat emission.

**On request:** Special accessories available on request.

### PMCN150EUM

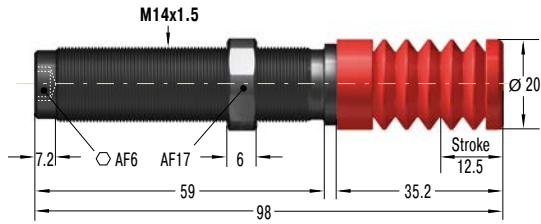

#### KM14 Locknut

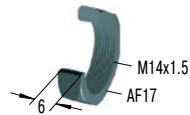

#### RF14 Rectangular Flange

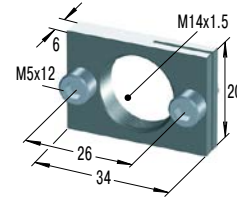

#### MB14 Clamp Mount

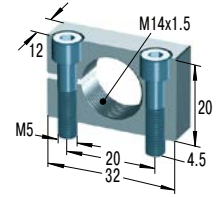

### PMCN225EUM

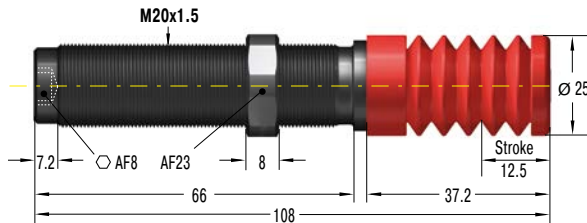

#### KM20 Locknut



#### RF20 Rectangular Flange

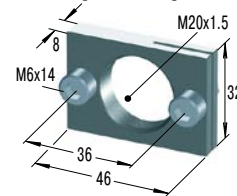

#### MB20 Clamp Mount

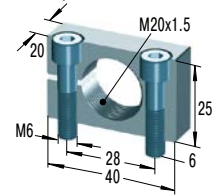

### PMCN600EUM

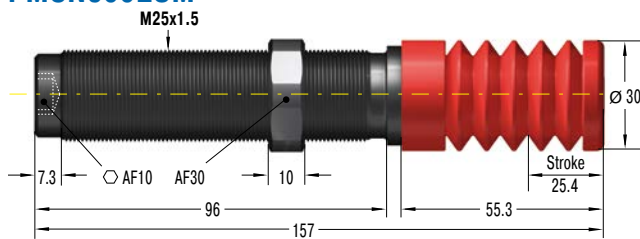

#### KM25 Locknut

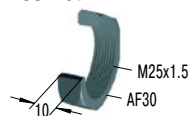

#### RF25 Rectangular Flange

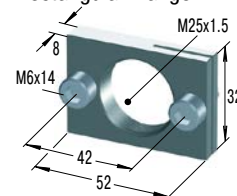

#### MB25 Clamp Mount

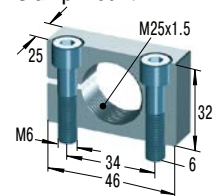

Additional accessories, mounting, installation ... see from page 36.

### Performance

| TYPES        | Max. Energy Capacity    |                     | Effective Weight |            | Return Force min. | Return Force max. | Return Time s | Side Load Angle max. ° | Weight kg |
|--------------|-------------------------|---------------------|------------------|------------|-------------------|-------------------|---------------|------------------------|-----------|
|              | W <sub>3</sub> Nm/cycle | W <sub>4</sub> Nm/h | me min. kg       | me max. kg |                   |                   |               |                        |           |
| PMCN150EUM   | 20                      | 34,000              | 0.9              | 10         | 8                 | 80                | 0.4           | 4                      | 0.07      |
| PMCN150EUMH  | 20                      | 34,000              | 8.6              | 86         | 8                 | 80                | 0.4           | 4                      | 0.07      |
| PMCN150EUMH2 | 20                      | 34,000              | 70.0             | 200        | 8                 | 80                | 0.4           | 4                      | 0.07      |
| PMCN150EUMH3 | 20                      | 34,000              | 181.0            | 408        | 8                 | 80                | 1.0           | 4                      | 0.07      |
| PMCN225EUM   | 41                      | 45,000              | 2.3              | 25         | 8                 | 85                | 0.3           | 4                      | 0.17      |
| PMCN225EUMH  | 41                      | 45,000              | 23               | 230        | 8                 | 85                | 0.3           | 4                      | 0.17      |
| PMCN225EUMH2 | 41                      | 45,000              | 180.0            | 910        | 8                 | 85                | 0.3           | 4                      | 0.17      |
| PMCN225EUMH3 | 41                      | 45,000              | 816.0            | 1,814      | 8                 | 85                | 0.3           | 4                      | 0.17      |
| PMCN600EUM   | 136                     | 68,000              | 9.0              | 136        | 8                 | 90                | 0.6           | 2                      | 0.32      |
| PMCN600EUMH  | 136                     | 68,000              | 113.0            | 1,130      | 8                 | 90                | 0.6           | 2                      | 0.32      |
| PMCN600EUMH2 | 136                     | 68,000              | 400              | 2,300      | 8                 | 90                | 0.6           | 2                      | 0.32      |
| PMCN600EUMH3 | 136                     | 68,000              | 2,177.0          | 4,536      | 8                 | 90                | 0.6           | 2                      | 0.32      |



## PMCN150-V4A to PMCN600-V4A

### Optimum corrosion protection

#### Self-Compensating, Rolling Diaphragm Technology, TPU Bellow

**Energy capacity 20 Nm/Cycle to 136 Nm/Cycle**  
**Stroke 12 mm to 25 mm**

Hermetically sealed and rustproof: The Protection series PMCN is also available in a stainless steel design. This is of particular interest to the food and packaging industries.

Their main special feature is the compact, totally sealed bellow between the body and the cap made of TPU (thermoplastic polyurethane). This protection safely encapsulates the ACE rolling diaphragm from the outside environment. Aggressive fluids don't stand a chance.

The PMCN series is an excellent alternative if the accessory option of the SP type air bleed collar cannot be used due to a lack of compressed air.

The PMCN series miniature shock absorbers, produced from stainless steel, are primarily suitable for use in the food industry, but are also wherever an elegant look is important e.g. in shipbuilding.

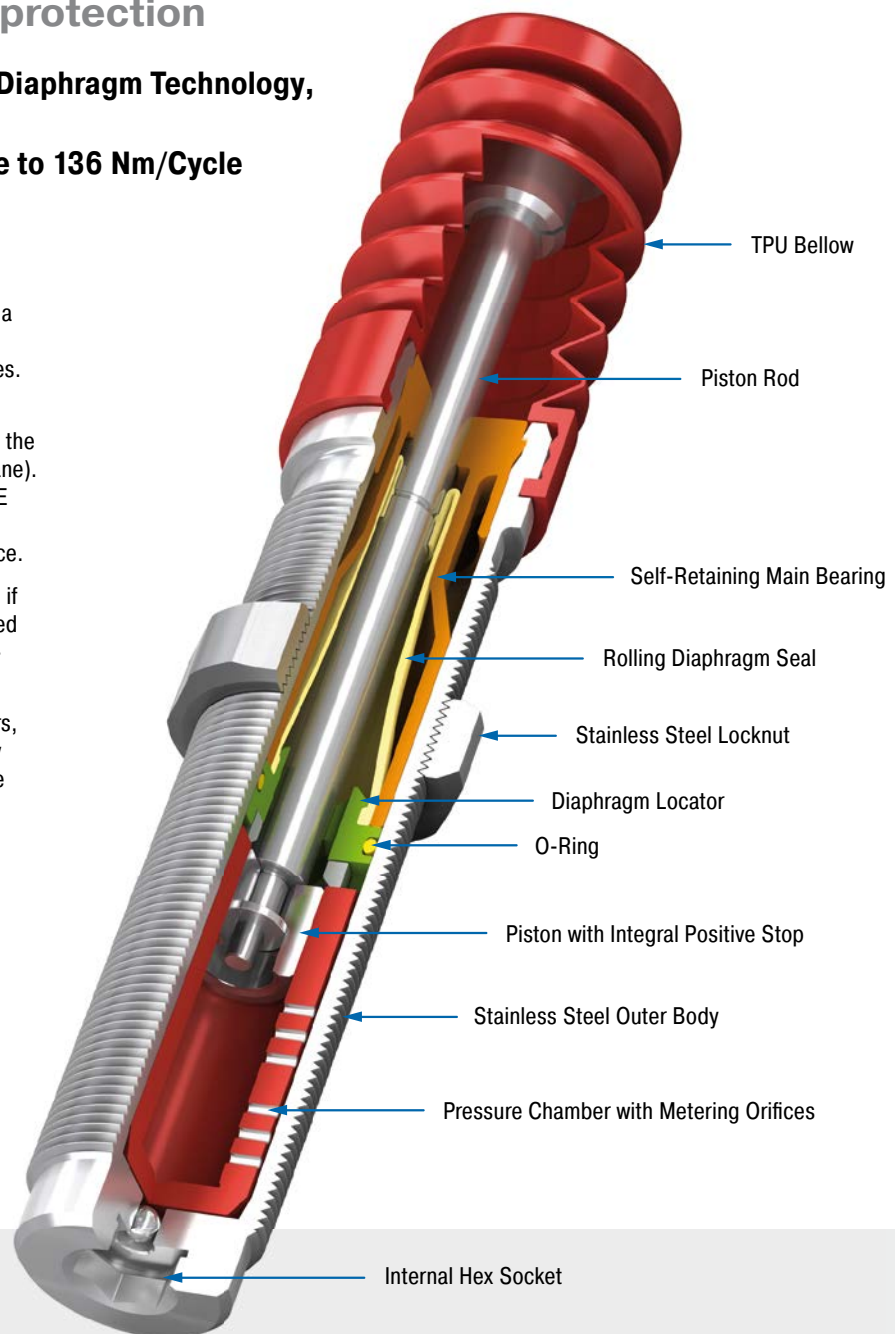

### Technical Data

**Energy capacity:** 20 Nm/Cycle to 136 Nm/Cycle

**Impact velocity range:** 0.06 m/s to 6 m/s.  
Other speeds on request.

**Operating temperature range:** 0 °C to 66 °C

**Mounting:** In any position

**Positive stop:** Integrated

**Material:** Outer body: Stainless steel (1.4404, AISI 316L); Main bearing: Plastic; Piston rod: Hardened stainless steel (1.4125, AISI 440C); Bellow: TPU, steel insert: Stainless steel (1.4404/1.4571, AISI 316L/316Ti); Rolling diaphragm: EPDM

**Damping medium:** Oil, temperature stable

**Application field:** Finishing and processing centres, Clean room areas, Pharmaceutical industry, Medical technology, Food industry, Machines and plants

**Note:** Final preliminary test must be done on the application.

**Safety instructions:** Do not paint the shock absorbers due to heat emission.

**On request:** Special accessories available on request.

### PMCN150EUM-V4A

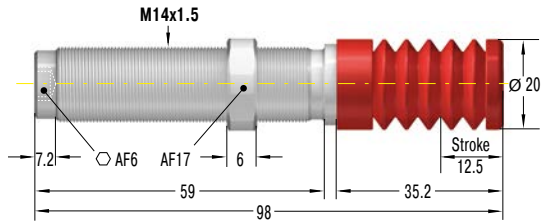

### KM14-V4A Locknut

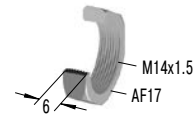

### MB14SC2-V4A Mounting Block

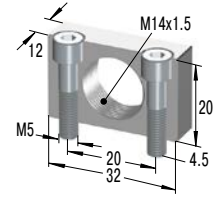

### PMCN225EUM-V4A

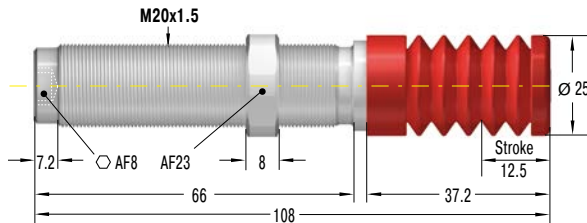

### KM20-V4A Locknut

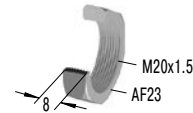

### MB20SC2-V4A Mounting Block

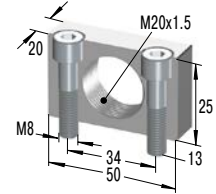

### PMCN600EUM-V4A

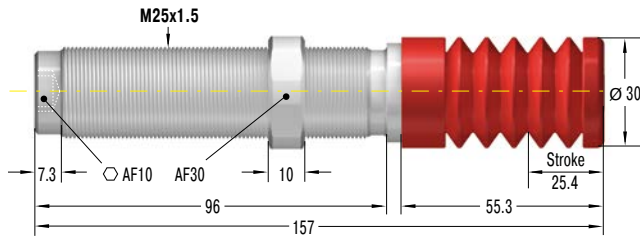

### KM25-V4A Locknut

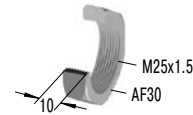

### MB25SC2-V4A Mounting Block

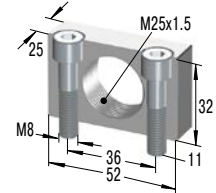

Additional accessories, mounting, installation ... see from page 36.

### Performance

| TYPES            | Max. Energy Capacity       |                        | Effective Weight |               | Return Force<br>min.<br>N | Return Force<br>max.<br>N | Return Time<br>s | Side Load Angle<br>max.<br>° | Weight<br>kg |
|------------------|----------------------------|------------------------|------------------|---------------|---------------------------|---------------------------|------------------|------------------------------|--------------|
|                  | W <sub>3</sub><br>Nm/cycle | W <sub>4</sub><br>Nm/h | me min.<br>kg    | me max.<br>kg |                           |                           |                  |                              |              |
| PMCN150EUM-V4A   | 20                         | 34,000                 | 0.9              | 10            | 8                         | 80                        | 0.4              | 4                            | 0.07         |
| PMCN150EUMH-V4A  | 20                         | 34,000                 | 8.6              | 86            | 8                         | 80                        | 0.4              | 4                            | 0.07         |
| PMCN150EUMH2-V4A | 20                         | 34,000                 | 70.0             | 200           | 8                         | 80                        | 0.4              | 4                            | 0.07         |
| PMCN150EUMH3-V4A | 20                         | 34,000                 | 181.0            | 408           | 8                         | 80                        | 1.0              | 4                            | 0.07         |
| PMCN225EUM-V4A   | 41                         | 45,000                 | 2.3              | 25            | 8                         | 85                        | 0.3              | 4                            | 0.17         |
| PMCN225EUMH-V4A  | 41                         | 45,000                 | 23.0             | 230           | 8                         | 85                        | 0.3              | 4                            | 0.17         |
| PMCN225EUMH2-V4A | 41                         | 45,000                 | 180.0            | 910           | 8                         | 85                        | 0.3              | 4                            | 0.17         |
| PMCN225EUMH3-V4A | 41                         | 45,000                 | 816.0            | 1,814         | 8                         | 85                        | 0.3              | 4                            | 0.17         |
| PMCN600EUM-V4A   | 136                        | 68,000                 | 9.0              | 136           | 8                         | 90                        | 0.6              | 2                            | 0.32         |
| PMCN600EUMH-V4A  | 136                        | 68,000                 | 113.0            | 1,130         | 8                         | 90                        | 0.6              | 2                            | 0.32         |
| PMCN600EUMH2-V4A | 136                        | 68,000                 | 400.0            | 2,300         | 8                         | 90                        | 0.6              | 2                            | 0.32         |
| PMCN600EUMH3-V4A | 136                        | 68,000                 | 2,177.0          | 4,536         | 8                         | 90                        | 0.6              | 2                            | 0.32         |

## SC190 to SC925

### Long stroke and soft impact

**Self-Compensating, Soft-Contact**  
**Energy capacity 25 Nm/Cycle to 110 Nm/Cycle**  
**Stroke 16 mm to 40 mm**

Ideal for soft damping: The SC found in the model code from the ACE series SC190 to 925 stands for 'soft contact'. These miniature shock absorbers manufactured from one solid piece are designed in such a way that they can be setup with a linear or a progressive braking curve. The soft damping character is thanks to the special, long strokes producing smooth deceleration and low reaction forces.

These maintenance-free, ready-to-install hydraulic machine elements are equipped with an integrated positive stop. The use of side load adapter allows impact angles of up to 25°. Thanks to the designed overlapping effective weight ranges, these dampers cover an effective load range of below 1 kg to more than 2,000 kg!

The miniature shock absorbers from the SC190 to 925 series are used in mechanical engineering and primarily in the areas of handling and automation.

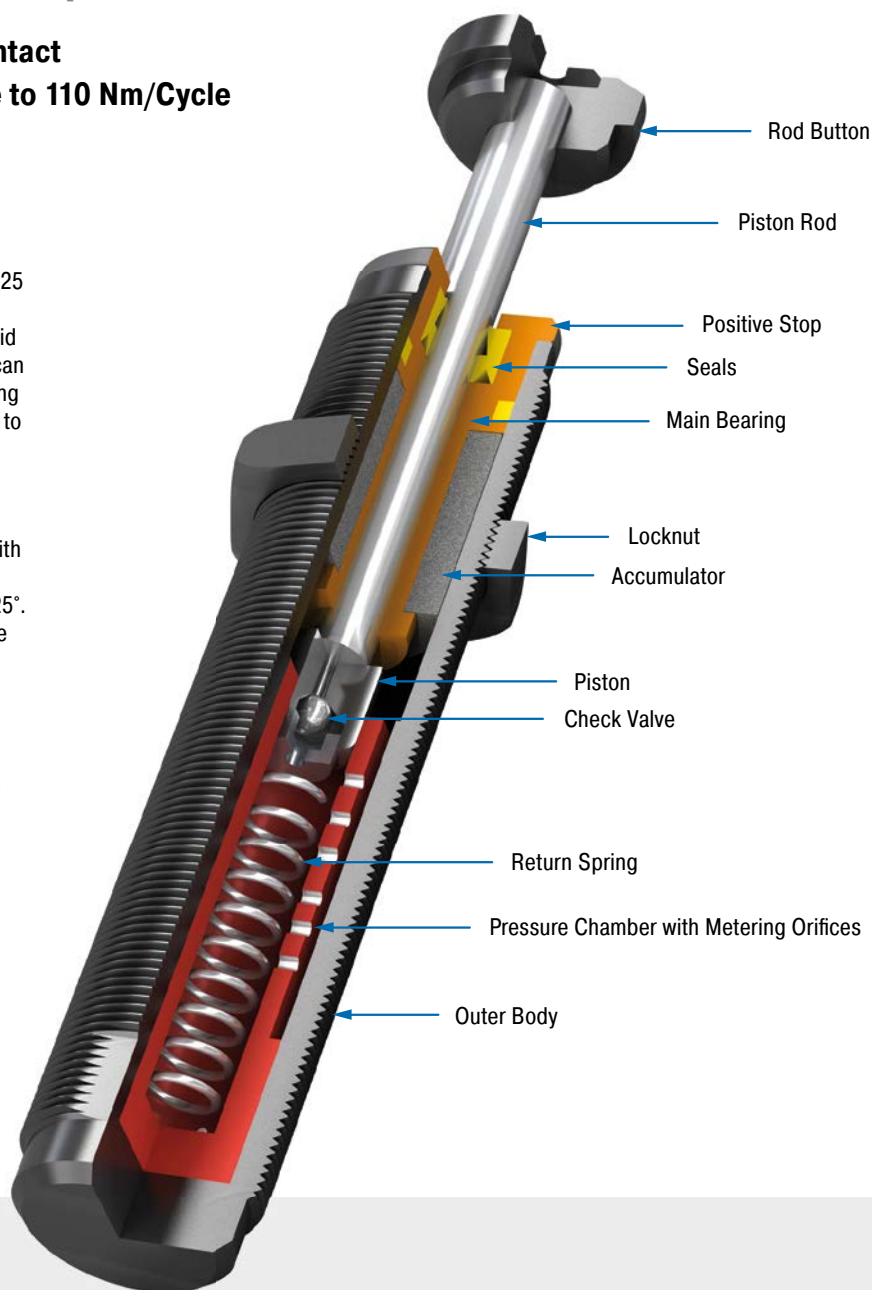

### Technical Data

**Energy capacity:** 25 Nm/Cycle to 110 Nm/Cycle

**Impact velocity range:** 0.15 m/s to 3.66 m/s. Other speeds on request.

**Operating temperature range:** 0 °C to 66 °C

**Mounting:** in any position

**Positive stop:** Integrated

**Material:** Outer body, Accessories: steel corrosion-resistant coating; Piston rod: hardened stainless steel

**Damping medium:** oil, temperature stable

**Application field:** linear slides, pneumatic cylinders, handling modules, machines and

plants, finishing and processing centres, measuring tables, tool machines

**Note:** If precise end position datum is required consider use of the stop collar type AH.

**Safety instructions:** External materials in the surrounding area can attack the seal components and lead to a shorter service life. Please contact ACE for appropriate solution suggestions. Do not paint the shock absorbers due to heat emission.

**On request:** Nickel-plated or wear-tec finish (seawater resistant) or other special finishes available to special order. Models without rod end button.



### SC190EUM; 0 to 4

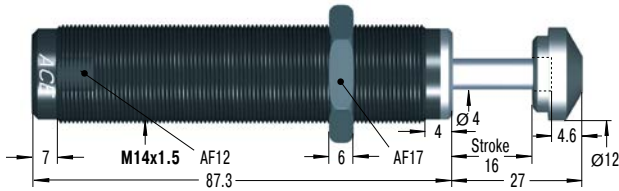

M14x1 and M16x1 also available to special order

### RF14 Rectangular Flange

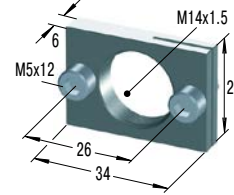

### MB14 Clamp Mount

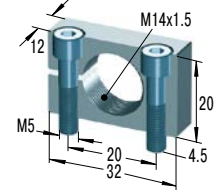

### SC300EUM; 0 to 4

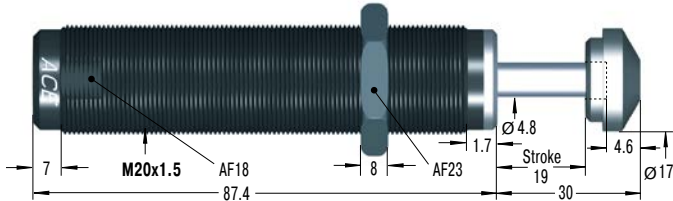

M22x1.5 also available to special order

### RF20 Rectangular Flange

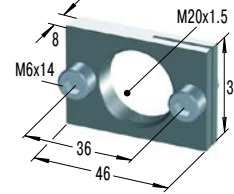

### MB20 Clamp Mount

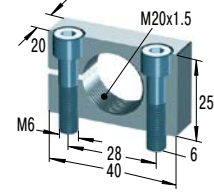

### SC650EUM; 0 to 4

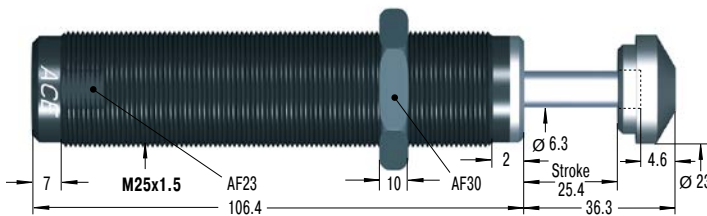

M26x1.5 also available to special order

### RF25 Rectangular Flange

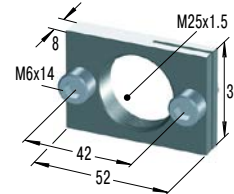

### MB25 Clamp Mount

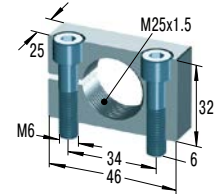

### SC925EUM; 0 to 4

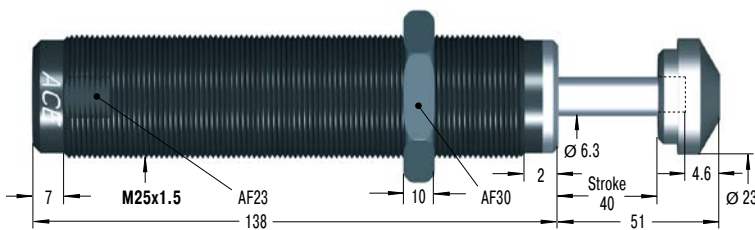

### RF25 Rectangular Flange

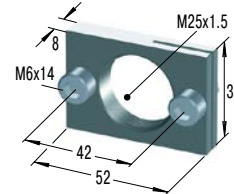

### MB25 Clamp Mount

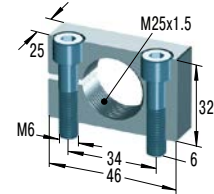

Additional accessories, mounting, installation ... see from page 36.

### Performance

| TYPES      | Max. Energy Capacity    |                     | Effective Weight |            |                   |            |          | Return Force min. N | Return Force max. N | Return Time s | Side Load Angle max. ° | Weight kg |
|------------|-------------------------|---------------------|------------------|------------|-------------------|------------|----------|---------------------|---------------------|---------------|------------------------|-----------|
|            | W <sub>3</sub> Nm/cycle | W <sub>4</sub> Nm/h | Soft-Contact     |            | Self-Compensating |            | Hardness |                     |                     |               |                        |           |
|            |                         |                     | me min. kg       | me max. kg | me min. kg        | me max. kg |          |                     |                     |               |                        |           |
| SC190EUM-0 | 25                      | 34,000              | -                | -          | 0.7               | 4          | -0       | 4                   | 9                   | 0.25          | 5                      | 0.08      |
| SC190EUM-1 | 25                      | 34,000              | 2.3              | 6          | 1.4               | 7          | -1       | 4                   | 9                   | 0.25          | 5                      | 0.08      |
| SC190EUM-2 | 25                      | 34,000              | 5.5              | 16         | 3.6               | 18         | -2       | 4                   | 9                   | 0.25          | 5                      | 0.08      |
| SC190EUM-3 | 25                      | 34,000              | 14               | 41         | 9.0               | 45         | -3       | 4                   | 9                   | 0.25          | 5                      | 0.08      |
| SC190EUM-4 | 25                      | 34,000              | 34               | 91         | 23.0              | 102        | -4       | 4                   | 9                   | 0.25          | 5                      | 0.08      |
| SC300EUM-0 | 33                      | 45,000              | -                | -          | 0.7               | 4          | -0       | 5                   | 10                  | 0.10          | 5                      | 0.18      |
| SC300EUM-1 | 33                      | 45,000              | 2.3              | 7          | 1.4               | 8          | -1       | 5                   | 10                  | 0.10          | 5                      | 0.18      |
| SC300EUM-2 | 33                      | 45,000              | 7                | 23         | 4.5               | 27         | -2       | 5                   | 10                  | 0.10          | 5                      | 0.18      |
| SC300EUM-3 | 33                      | 45,000              | 23               | 68         | 14.0              | 82         | -3       | 5                   | 10                  | 0.10          | 5                      | 0.18      |
| SC300EUM-4 | 33                      | 45,000              | 68               | 181        | 32.0              | 204        | -4       | 5                   | 10                  | 0.10          | 5                      | 0.18      |
| SC650EUM-0 | 73                      | 68,000              | -                | -          | 2.3               | 14         | -0       | 11                  | 32                  | 0.20          | 5                      | 0.34      |
| SC650EUM-1 | 73                      | 68,000              | 11               | 36         | 8.0               | 45         | -1       | 11                  | 32                  | 0.20          | 5                      | 0.34      |
| SC650EUM-2 | 73                      | 68,000              | 34               | 113        | 23.0              | 136        | -2       | 11                  | 32                  | 0.20          | 5                      | 0.34      |
| SC650EUM-3 | 73                      | 68,000              | 109              | 363        | 68.0              | 408        | -3       | 11                  | 32                  | 0.20          | 5                      | 0.34      |
| SC650EUM-4 | 73                      | 68,000              | 363              | 1,089      | 204.0             | 1,180      | -4       | 11                  | 32                  | 0.20          | 5                      | 0.34      |
| SC925EUM-0 | 110                     | 90,000              | 8                | 25         | 4.5               | 29         | -0       | 11                  | 32                  | 0.40          | 5                      | 0.42      |
| SC925EUM-1 | 110                     | 90,000              | 22               | 72         | 14.0              | 90         | -1       | 11                  | 32                  | 0.40          | 5                      | 0.42      |
| SC925EUM-2 | 110                     | 90,000              | 59               | 208        | 40.0              | 227        | -2       | 11                  | 32                  | 0.40          | 5                      | 0.42      |
| SC925EUM-3 | 110                     | 90,000              | 181              | 612        | 113.0             | 726        | -3       | 11                  | 32                  | 0.40          | 5                      | 0.42      |
| SC925EUM-4 | 110                     | 90,000              | 544              | 1,952      | 340.0             | 2,088      | -4       | 11                  | 32                  | 0.40          | 5                      | 0.42      |

<sup>1</sup> For applications with higher side load angles consider using the side load adaptor (BV) pages 38 to 45.

## SC<sup>2</sup>25 to SC<sup>2</sup>190

Piston tube design for maximum energy absorption

**Self-Compensating, Piston Tube Technology**  
**Energy capacity 10 Nm/Cycle to 31 Nm/Cycle**  
**Stroke 8 mm to 12 mm**

Soft damping, but enormous capacity: The range of 'soft contact' absorbers SC<sup>2</sup>25 to 190 extends from thread size M10 to M14 and covers effective weight ranges of 1 kg to 1,550 kg. All models are characterised by high energy absorption and they also unite the piston tube technology with the diaphragm seal perfected by ACE. This enables direct installation as end position damping in pneumatic cylinders at 5 to 7 bar or applications where deceleration needs to take place close to the pivot point.

They are maintenance-free, have an integrated positive stop and are mountable in any position. The option of a side load adapter allows impact angles of up to 25°.

Thanks to their robust design and their durability, these miniature shock absorbers can be used for a wide range of applications. Designers mainly use them for pick and place systems, pneumatic rotary modules and in automation applications.

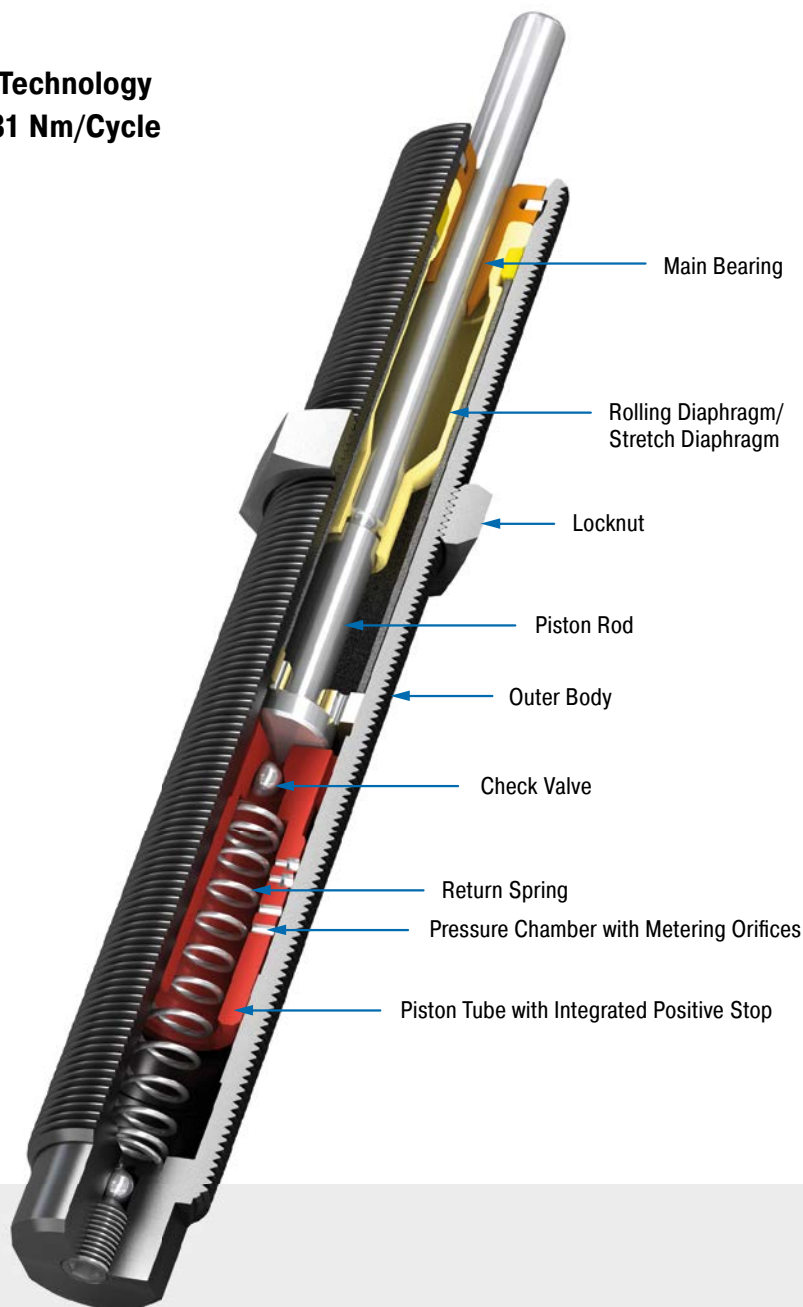

### Technical Data

**Energy capacity:** 10 Nm/Cycle to 31 Nm/Cycle

**Impact velocity range:** 0.1 m/s to 5.7 m/s.  
Other speeds on request.

**Operating temperature range:** 0 °C to 66 °C

**Mounting:** In any position

**Positive stop:** Integrated

**Material:** Outer body, Accessories: Steel corrosion-resistant coating; Piston rod: hardened stainless steel; Rolling diaphragm: SC<sup>2</sup>190: EPDM; Stretch diaphragm: SC<sup>2</sup>25 and SC<sup>2</sup>75: Nitrile

**Damping medium:** Oil, temperature stable

**Application field:** Linear slides, Pneumatic cylinders, Swivel units, Handling modules, Machines and plants, Finishing and processing centres, Measuring tables, Tool machines, Locking systems

**Note:** If precise end position datum is required consider use of the stop collar type AH.

**Safety instructions:** External materials in the surrounding area can attack the rolling and stretch seals and lead to a shorter service life. Please contact ACE for appropriate solution suggestions.

**On request:** Increased corrosion protection. Special finishes.

### SC25EUM; 5 to 7

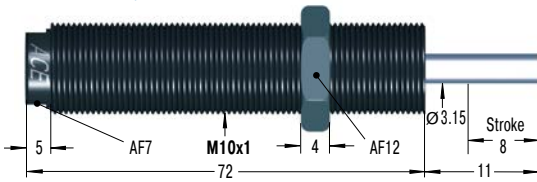

#### RF10 Rectangular Flange

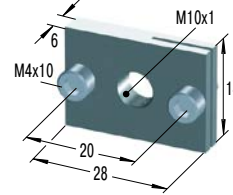

#### MB10SC2 Mounting Block

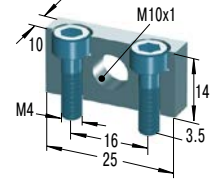

### SC75EUM; 5 to 7

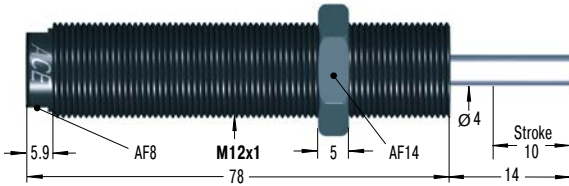

#### RF12 Rectangular Flange

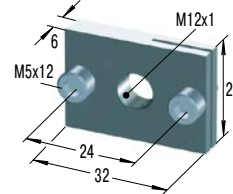

#### MB12SC2 Mounting Block

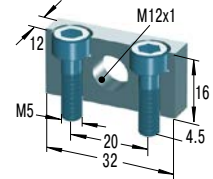

### SC190EUM; 5 to 7

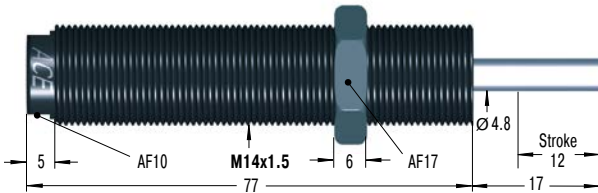

M14x1 also available to special order

#### RF14 Rectangular Flange

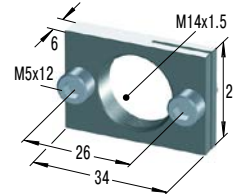

#### MB14SC2 Mounting Block

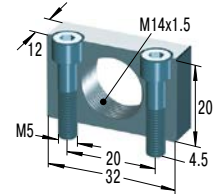

Additional accessories, mounting, installation ... see from page 36.

### Performance

| TYPES      | Max. Energy Capacity       |                        | Effective Weight |               |          | Return Force min.<br>N | Return Force max.<br>N | Return Time<br>s | Side Load Angle<br>max.<br>° | Weight<br>kg |
|------------|----------------------------|------------------------|------------------|---------------|----------|------------------------|------------------------|------------------|------------------------------|--------------|
|            | W <sub>3</sub><br>Nm/cycle | W <sub>4</sub><br>Nm/h | me min.<br>kg    | me max.<br>kg | Hardness |                        |                        |                  |                              |              |
| SC25EUM-5  | 10                         | 16,000                 | 1                | 5             | -5       | 4.5                    | 14                     | 0.3              | 2                            | 0.029        |
| SC25EUM-6  | 10                         | 16,000                 | 4                | 44            | -6       | 4.5                    | 14                     | 0.3              | 2                            | 0.029        |
| SC25EUM-7  | 10                         | 16,000                 | 42               | 500           | -7       | 4.5                    | 14                     | 0.3              | 2                            | 0.029        |
| SC75EUM-5  | 16                         | 30,000                 | 1                | 8             | -5       | 6.0                    | 19                     | 0.3              | 2                            | 0.047        |
| SC75EUM-6  | 16                         | 30,000                 | 7                | 78            | -6       | 6.0                    | 19                     | 0.3              | 2                            | 0.047        |
| SC75EUM-7  | 16                         | 30,000                 | 75               | 800           | -7       | 6.0                    | 19                     | 0.3              | 2                            | 0.047        |
| SC190EUM-5 | 31                         | 50,000                 | 2                | 16            | -5       | 6.0                    | 19                     | 0.4              | 2                            | 0.055        |
| SC190EUM-6 | 31                         | 50,000                 | 13               | 140           | -6       | 6.0                    | 19                     | 0.4              | 2                            | 0.055        |
| SC190EUM-7 | 31                         | 50,000                 | 136              | 1,550         | -7       | 6.0                    | 19                     | 0.4              | 2                            | 0.055        |

<sup>1</sup> For applications with higher side load angles consider using the side load adaptor (BV) pages 38 to 45.

## SC<sup>2</sup>300 to SC<sup>2</sup>650

Piston tube design for maximum energy absorption

**Self-Compensating, Piston Tube Technology**  
**Energy capacity 73 Nm/Cycle to 210 Nm/Cycle**  
**Stroke 15 mm to 23 mm**

Added safety with accumulator technology: The larger 'soft contact' models from the SC<sup>2</sup>300 to 650 are available with up to three times the energy absorption compared to similar sizes of standard shock absorbers SC190 to 925, due to the ACE piston tube speciality. Furthermore, the membrane accumulator serves as a compensation element for the oil displaced in the shock absorber and replaces the standard use of absorber materials. This increases process safety even further.

The absorbers, which are perfect for rotary modules for example, are available in progressively stepped effective weight ranges with an integrated positive stop. They are maintenance-free and ready for direct installation. The side load adapter option allows impact angles of up to 25°.

These miniature shock absorbers offer high performance levels with a long service life and are particularly popular for handling, mounting very close to pivots and automation tasks.

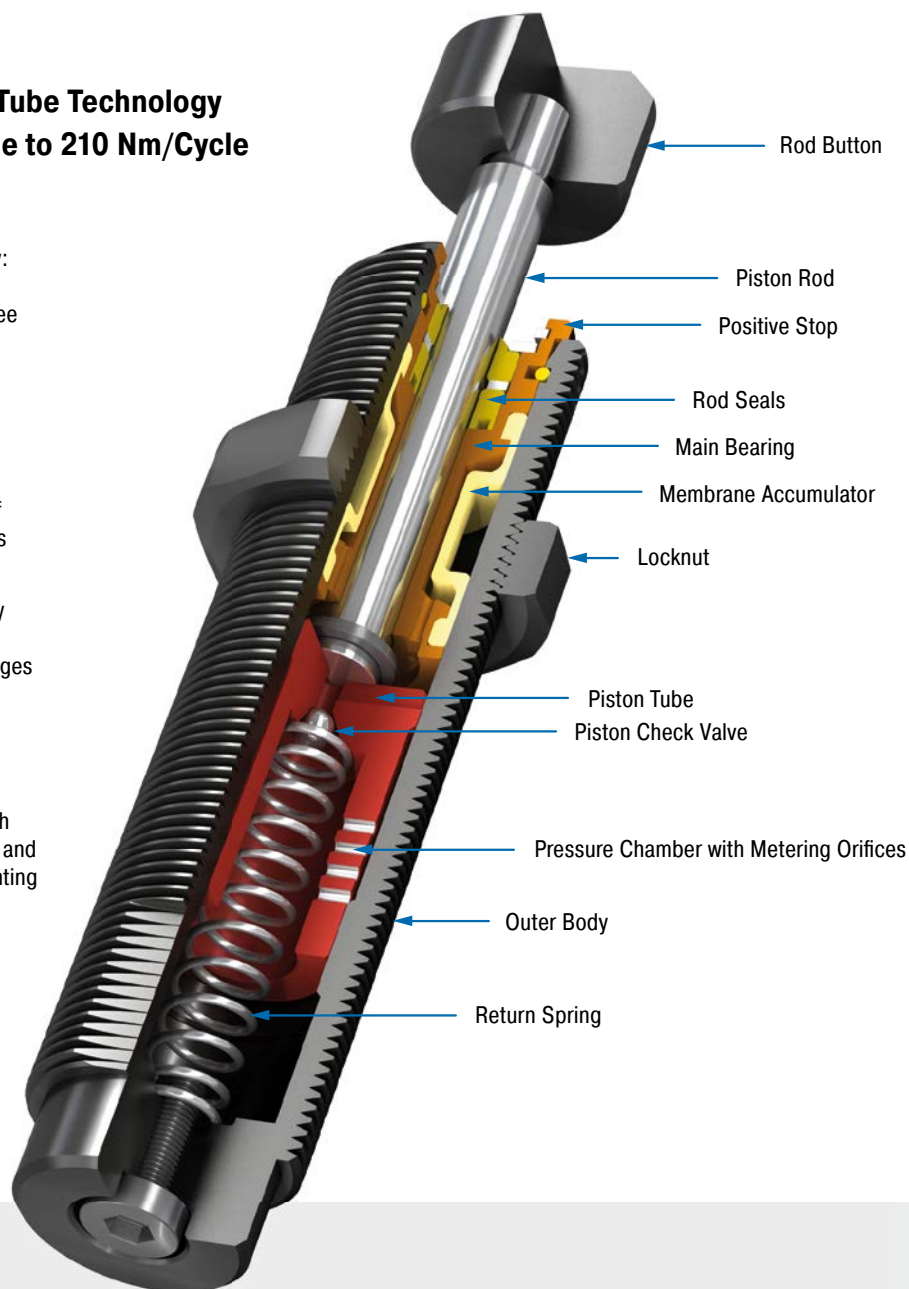

### Technical Data

**Energy capacity:** 73 Nm/Cycle to 210 Nm/Cycle

**Impact velocity range:** 0.09 m/s to 3.66 m/s. Other speeds on request.

**Operating temperature range:** 0 °C to 66 °C

**Mounting:** in any position

**Positive stop:** Integrated

**Material:** Outer body: steel corrosion-resistant coating; Piston rod: hardened stainless steel; Accessories: hardened steel and corrosion-resistant coating

**Damping medium:** oil, temperature stable

**Application field:** turntables, swivel units, robot arms, linear slides, pneumatic cylinders, handling modules, machines and plants, finishing and processing centres, tool machines

**Note:** If precise end position datum is required consider use of the stop collar type AH.

**On request:** Increased corrosion protection. Special finishes.



### SC300EUM; 5 to 9

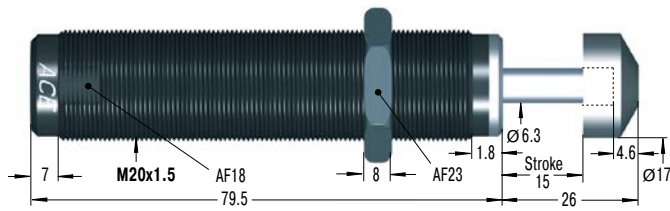

#### RF20 Rectangular Flange

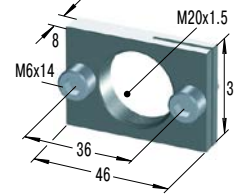

#### MB20SC2 Mounting Block

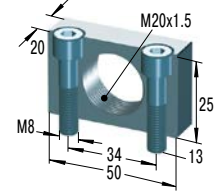

### SC650EUM; 5 to 9

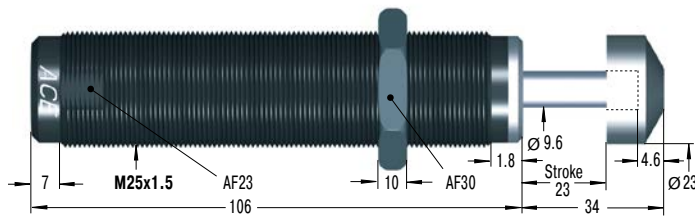

#### RF25 Rectangular Flange

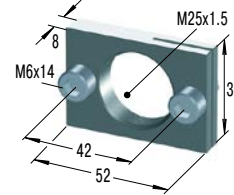

#### MB25SC2 Mounting Block

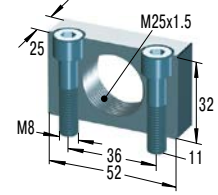

Additional accessories, mounting, installation ... see from page 36.

### Performance

| TYPES      | Max. Energy Capacity             |                              | Effective Weight     |                      |          | Return Force min.<br><b>N</b> | Return Force max.<br><b>N</b> | Return Time<br><b>s</b> | Side Load Angle<br>max.<br><b>°</b> | Weight<br><b>kg</b> |
|------------|----------------------------------|------------------------------|----------------------|----------------------|----------|-------------------------------|-------------------------------|-------------------------|-------------------------------------|---------------------|
|            | <b>W<sub>3</sub></b><br>Nm/cycle | <b>W<sub>4</sub></b><br>Nm/h | me min.<br><b>kg</b> | me max.<br><b>kg</b> | Hardness |                               |                               |                         |                                     |                     |
| SC300EUM-5 | 73                               | 45,000                       | 11                   | 45                   | -5       | 8                             | 18                            | 0.2                     | 5                                   | 0.150               |
| SC300EUM-6 | 73                               | 45,000                       | 34                   | 136                  | -6       | 8                             | 18                            | 0.2                     | 5                                   | 0.150               |
| SC300EUM-7 | 73                               | 45,000                       | 91                   | 181                  | -7       | 8                             | 18                            | 0.2                     | 5                                   | 0.150               |
| SC300EUM-8 | 73                               | 45,000                       | 135                  | 680                  | -8       | 8                             | 18                            | 0.2                     | 5                                   | 0.150               |
| SC300EUM-9 | 73                               | 45,000                       | 320                  | 1,950                | -9       | 8                             | 18                            | 0.2                     | 5                                   | 0.150               |
| SC650EUM-5 | 210                              | 68,000                       | 23                   | 113                  | -5       | 11                            | 33                            | 0.3                     | 5                                   | 0.310               |
| SC650EUM-6 | 210                              | 68,000                       | 90                   | 360                  | -6       | 11                            | 33                            | 0.3                     | 5                                   | 0.310               |
| SC650EUM-7 | 210                              | 68,000                       | 320                  | 1,090                | -7       | 11                            | 33                            | 0.3                     | 5                                   | 0.310               |
| SC650EUM-8 | 210                              | 68,000                       | 770                  | 2,630                | -8       | 11                            | 33                            | 0.3                     | 5                                   | 0.310               |
| SC650EUM-9 | 210                              | 68,000                       | 1,800                | 6,350                | -9       | 11                            | 33                            | 0.3                     | 5                                   | 0.310               |

<sup>1</sup> For applications with higher side load angles consider using the side load adaptor (BV) pages 38 to 45.

## MA30 to MA900

### Stepless adjustment

#### Adjustable

**Energy capacity 3.5 Nm/Cycle to 100 Nm/Cycle**

**Stroke 8 mm to 40 mm**

The miniature shock absorbers from the MA30 to MA900 series can be adjusted and precisely adapted to your requirements. For example, the MA150 displays the rolling diaphragm technology from the MC150 to MC600 family and offers all of the advantages of this technology, such as use in pressure chambers. Thanks to long strokes (including 40 mm on the MA900) lower reaction forces result, which provide a soft damping characteristic.

All variations of these units are maintenance-free, ready-to-install machine elements and have an integrated positive stop. They provide the best service where application data changes, where the calculation parameters are not clear or where maximum flexibility in the possible usage is required.

The adjustable miniature shock absorbers from ACE can be used to meet precisely the customer's application and are therefore found everywhere in mechanical engineering and many other applications.

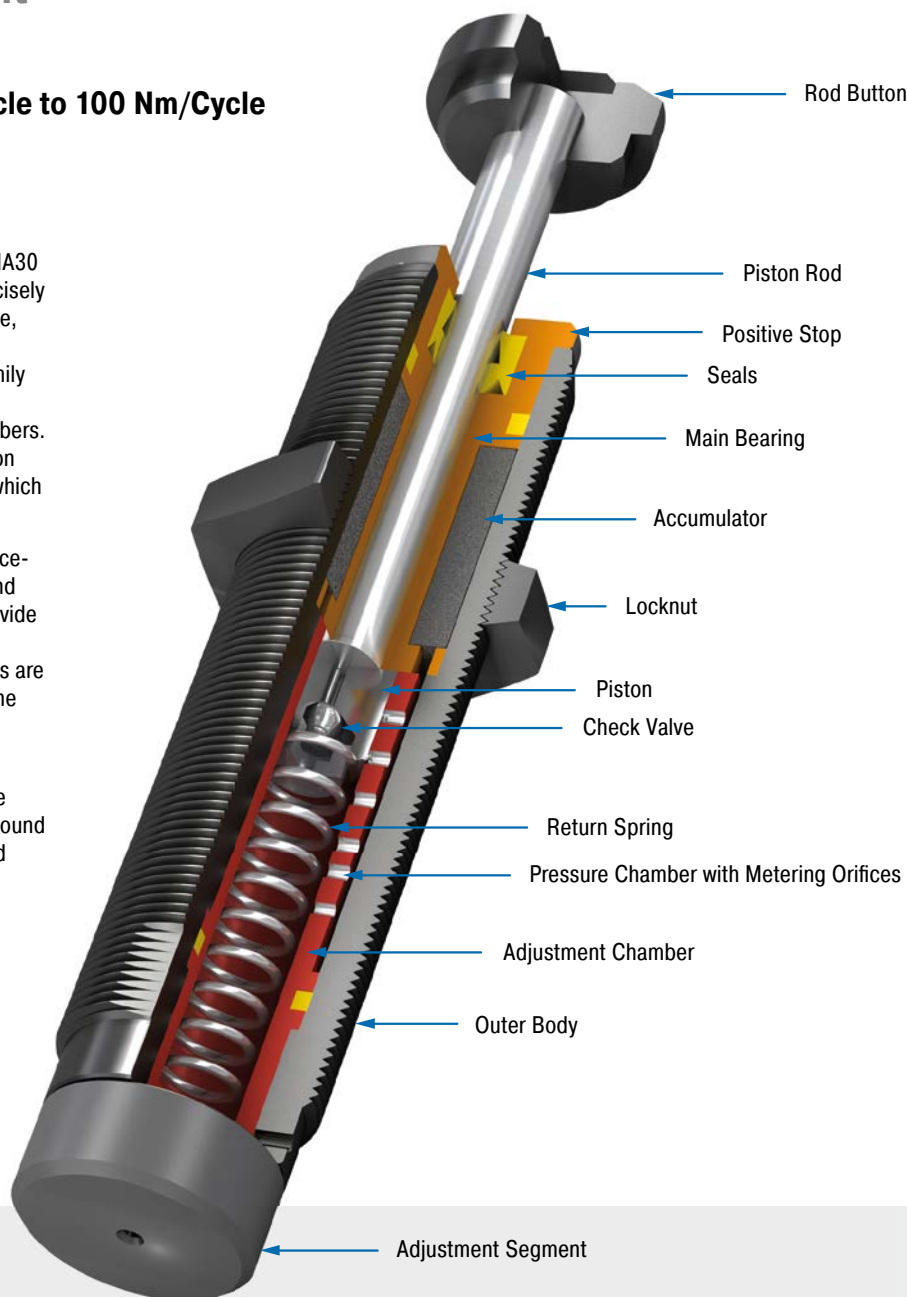

#### Technical Data

**Energy capacity:** 3.5 Nm/Cycle to 100 Nm/Cycle

**Impact velocity range:** 0.15 m/s to 4.5 m/s. Other speeds on request.

**Operating temperature range:** 0 °C to 66 °C

**Mounting:** in any position

**Positive stop:** Integrated

**Adjustment:** Hard impact at the start of stroke, adjust the ring towards 9 or PLUS. Hard impact at the end of stroke, adjust the ring towards 0 or MINUS.

**Material:** Outer body, Accessories: steel corrosion-resistant coating; Piston rod: hardened stainless steel

**Damping medium:** oil, temperature stable

**Application field:** linear slides, pneumatic cylinders, swivel units, handling modules, machines and plants, finishing and processing centres, automatic machinery, tool machines, locking systems

**Note:** If precise end position datum is required consider use of the stop collar type AH. Shock absorber is preset at delivery in a neutral position between hard and soft.

**Safety instructions:** External materials in the surrounding area can attack the seal components and lead to a shorter service life. Please contact ACE for appropriate solution sugges-

tions. Do not paint the shock absorbers due to heat emission.

**On request:** Nickel-plated or other special options available to special order. Models without rod end button.

### MA30EUM

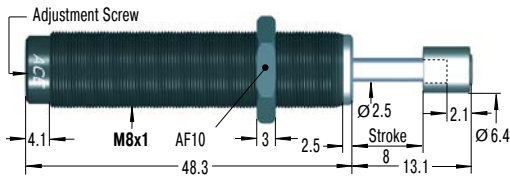

### RF8 Rectangular Flange

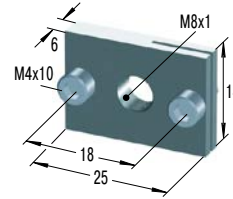

### MB8SC2 Mounting Block

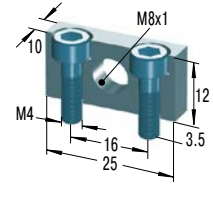

### MA50EUM-B

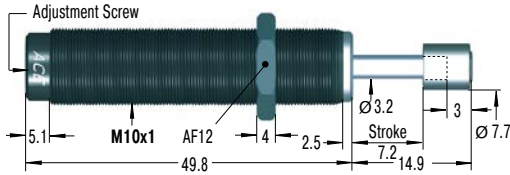

### RF10 Rectangular Flange

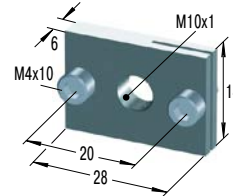

### MB10SC2 Mounting Block

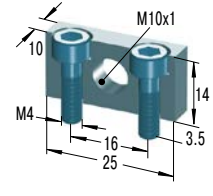

### MA35EUM

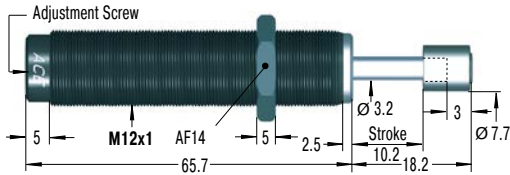

### RF12 Rectangular Flange

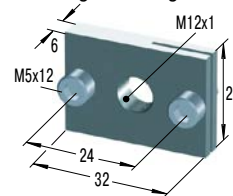

### MB12 Clamp Mount

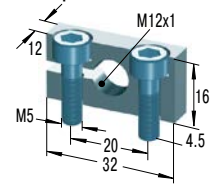

### MA150EUM

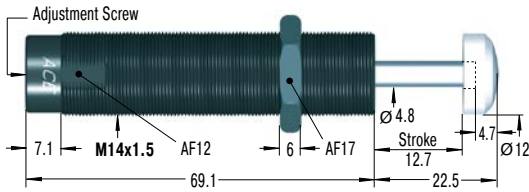

M14x1 also available to special order

### RF14 Rectangular Flange

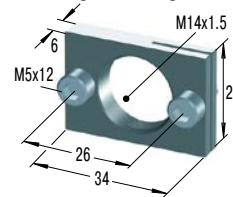

### MB14 Clamp Mount

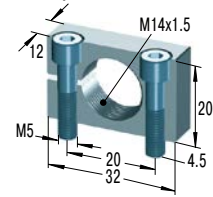

### MA225EUM

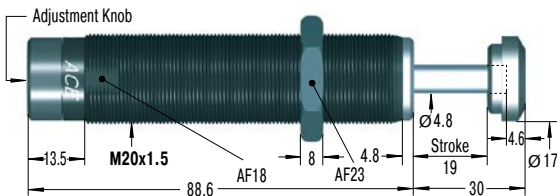

### RF20 Rectangular Flange

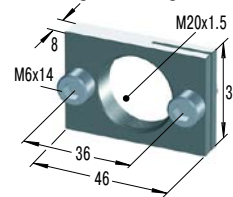

### MB20 Clamp Mount

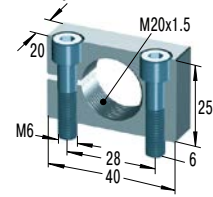

### MA600EUM / MA900EUM

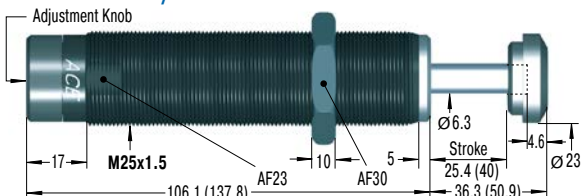

Dimensions for MA900EUM in ( ). MA600EUM with M27x3 available to special order

### RF25 Rectangular Flange

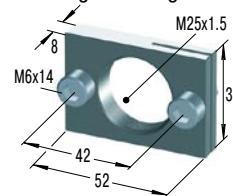

### MB25 Clamp Mount

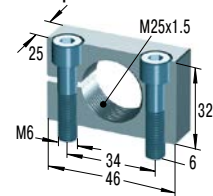

Additional accessories, mounting, installation ... see from page 36.

### Performance

| TYPES     | Max. Energy Capacity       |                        | Effective Weight |               | Return Force min.<br>N | Return Force max.<br>N | Return Time<br>s | Side Load Angle<br>max. ° | Weight<br>kg |
|-----------|----------------------------|------------------------|------------------|---------------|------------------------|------------------------|------------------|---------------------------|--------------|
|           | W <sub>3</sub><br>Nm/cycle | W <sub>4</sub><br>Nm/h | me min.<br>kg    | me max.<br>kg |                        |                        |                  |                           |              |
| MA30EUM   | 3.5                        | 5,650                  | 0.23             | 15            | 1.7                    | 5.3                    | 0.3              | 2.0                       | 0.011        |
| MA50EUM-B | 5.5                        | 13,550                 | 4.50             | 20            | 3.0                    | 6.0                    | 0.3              | 2.0                       | 0.025        |
| MA35EUM   | 4.0                        | 6,000                  | 6.00             | 57            | 5.0                    | 11.0                   | 0.2              | 2.0                       | 0.045        |
| MA150EUM  | 22.0                       | 35,000                 | 1.00             | 109           | 3.0                    | 5.0                    | 0.4              | 2.0                       | 0.061        |
| MA225EUM  | 25.0                       | 45,000                 | 2.30             | 226           | 5.0                    | 10.0                   | 0.1              | 2.0                       | 0.173        |
| MA600EUM  | 68.0                       | 68,000                 | 9.00             | 1,360         | 10.0                   | 30.0                   | 0.2              | 2.0                       | 0.352        |
| MA900EUM  | 100.0                      | 90,000                 | 14.00            | 2,040         | 10.0                   | 35.0                   | 0.4              | 1.0                       | 0.414        |

<sup>1</sup> For applications with higher side load angles consider using the side load adaptor (BV) pages 38 to 45.



Selection Chart

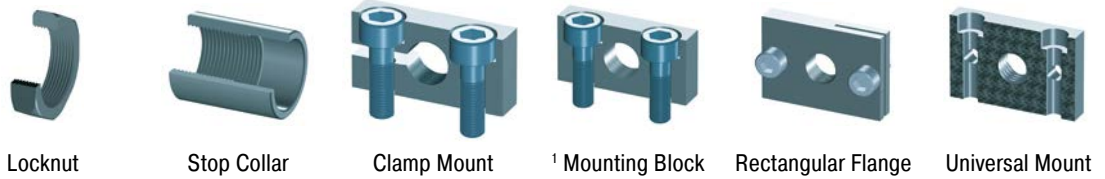

| Shock Absorber Type   | KM       | AH       | MB   | MBSC2       | RF   | UM   |
|-----------------------|----------|----------|------|-------------|------|------|
| <b>Thread M5x0.5</b>  |          |          |      |             |      |      |
| MC5EUM                | KM5      | AH5      | –    | MB5SC2      | –    | –    |
| <b>Thread M6x0.5</b>  |          |          |      |             |      |      |
| MC9EUM                | KM6      | AH6      | –    | MB6SC2      | RF6  | –    |
| <b>Thread M8x1</b>    |          |          |      |             |      |      |
| MA30EUM               | KM8      | AH8      | –    | MB8SC2      | RF8  | –    |
| MC10EUM               | KM8      | AH8      | –    | MB8SC2      | RF8  | –    |
| MC30EUM               | KM8      | AH8      | –    | MB8SC2      | RF8  | –    |
| <b>Thread M10x1</b>   |          |          |      |             |      |      |
| MA50EUM-B             | KM10     | AH10     | –    | MB10SC2     | RF10 | UM10 |
| MC25EUM               | KM10     | AH10     | –    | MB10SC2     | RF10 | UM10 |
| SC25EUM; 5 to 7       | KM10     | AH10     | –    | MB10SC2     | RF10 | UM10 |
| <b>Thread M12x1</b>   |          |          |      |             |      |      |
| MA35EUM               | KM12     | AH12     | MB12 | –           | RF12 | UM12 |
| MC75EUM               | KM12     | AH12     | MB12 | –           | RF12 | UM12 |
| SC75EUM; 5 to 7       | KM12     | AH12     | –    | MB12SC2     | RF12 | UM12 |
| <b>Thread M14x1.5</b> |          |          |      |             |      |      |
| MA150EUM              | KM14     | AH14     | MB14 | –           | RF14 | UM14 |
| MC150EUM              | KM14     | AH14     | MB14 | –           | RF14 | UM14 |
| MC150EUM-V4A          | KM14-V4A | AH14-V4A | –    | MB14SC2-V4A | –    | –    |
| PMCN150EUM            | KM14     | –        | MB14 | –           | RF14 | UM14 |
| PMCN150EUM-V4A        | KM14-V4A | –        | –    | MB14SC2-V4A | –    | –    |
| SC190EUM; 0 to 4      | KM14     | AH14     | MB14 | –           | RF14 | UM14 |
| SC190EUM; 5 to 7      | KM14     | AH14     | –    | MB14SC2     | RF14 | UM14 |
| <b>Thread M20x1.5</b> |          |          |      |             |      |      |
| MA225EUM              | KM20     | AH20     | MB20 | –           | RF20 | UM20 |
| MC225EUM              | KM20     | AH20     | MB20 | –           | RF20 | UM20 |
| MC225EUM-V4A          | KM20-V4A | AH20-V4A | –    | MB20SC2-V4A | –    | –    |
| PMCN225EUM            | KM20     | –        | MB20 | –           | RF20 | UM20 |
| PMCN225EUM-V4A        | KM20-V4A | –        | –    | MB20SC2-V4A | –    | –    |
| SC300EUM; 0 to 4      | KM20     | AH20     | MB20 | –           | RF20 | UM20 |
| SC300EUM; 5 to 9      | KM20     | AH20     | –    | MB20SC2     | RF20 | UM20 |
| <b>Thread M25x1.5</b> |          |          |      |             |      |      |
| MA600EUM              | KM25     | AH25     | MB25 | –           | RF25 | UM25 |
| MA900EUM              | KM25     | AH25     | MB25 | –           | RF25 | UM25 |
| MC600EUM              | KM25     | AH25     | MB25 | –           | RF25 | UM25 |
| MC600EUM-V4A          | KM25-V4A | AH25-V4A | –    | MB25SC2-V4A | –    | –    |
| PMCN600EUM            | KM25     | –        | MB25 | –           | RF25 | UM25 |
| PMCN600EUM-V4A        | KM25-V4A | –        | –    | MB25SC2-V4A | –    | –    |
| SC650EUM; 0 to 4      | KM25     | AH25     | MB25 | –           | RF25 | UM25 |
| SC650EUM; 5 to 9      | KM25     | AH25     | –    | MB25SC2     | RF25 | UM25 |
| SC925EUM; 0 to 4      | KM25     | AH25     | MB25 | –           | RF25 | UM25 |

<sup>1</sup> Use a locknut for protection if a clamp mount MB...SC2 is installed.

<sup>2</sup> Only mountable on units without button.  
Remove the button from the shock absorber, if there's one fitted!

Dimensions can be found on the corresponding accessories pages.

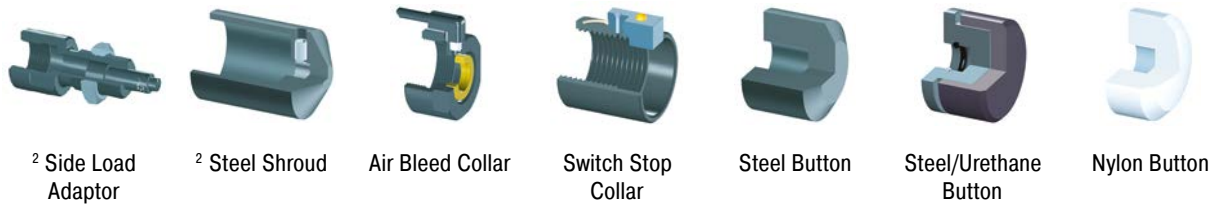

|                       | <b>BV</b> | <b>PB</b> | <b>SP</b> | <b>AS</b> | <b>PS</b> | <b>BP</b> | <b>PP</b> | Page |
|-----------------------|-----------|-----------|-----------|-----------|-----------|-----------|-----------|------|
| <b>Thread M5x0.5</b>  |           |           |           |           |           |           |           |      |
| -                     | -         | -         | -         | -         | -         | -         | -         | 38   |
| <b>Thread M6x0.5</b>  |           |           |           |           |           |           |           |      |
| -                     | -         | -         | -         | -         | -         | -         | -         | 38   |
| <b>Thread M8x1</b>    |           |           |           |           |           |           |           |      |
| BV8                   | PB8       | -         | -         | -         | -         | -         | -         | 38   |
| BV8A                  | PB8-A     | -         | -         | -         | -         | -         | -         | 38   |
| BV8                   | PB8       | -         | -         | -         | -         | -         | -         | 38   |
| <b>Thread M10x1</b>   |           |           |           |           |           |           |           |      |
| BV10                  | PB10      | -         | AS10      | PS10      | -         | -         | -         | 39   |
| BV10                  | PB10      | -         | AS10      | PS10      | -         | -         | -         | 39   |
| BV10SC                | PB10SC    | -         | -         | -         | -         | -         | -         | 39   |
| <b>Thread M12x1</b>   |           |           |           |           |           |           |           |      |
| BV12                  | PB12      | -         | AS12      | PS12      | -         | -         | -         | 39   |
| BV12                  | PB12      | -         | AS12      | PS12      | -         | -         | -         | 39   |
| BV12SC                | PB12SC    | SP12      | AS12      | PS12SC    | -         | -         | -         | 39   |
| <b>Thread M14x1.5</b> |           |           |           |           |           |           |           |      |
| BV14                  | PB14      | SP14      | AS14      | PS14      | -         | -         | included  | 40   |
| BV14                  | PB14      | SP14      | AS14      | PS14      | -         | -         | PP150     | 40   |
| -                     | -         | -         | -         | -         | -         | -         | PP150     | 40   |
| -                     | -         | -         | -         | -         | -         | -         | -         | 40   |
| -                     | -         | -         | -         | -         | -         | -         | -         | 40   |
| BV14SC                | PB14SC    | -         | AS14      | included  | BP14      | -         | -         | 40   |
| BV14                  | PB14      | SP14      | AS14      | PS14      | -         | -         | -         | 40   |
| <b>Thread M20x1.5</b> |           |           |           |           |           |           |           |      |
| BV20SC                | PB20SC    | -         | AS20      | included  | BP20      | -         | -         | 41   |
| BV20                  | PB20      | SP20      | AS20      | PS20      | -         | -         | PP225     | 41   |
| -                     | -         | -         | -         | -         | -         | -         | PP225     | 41   |
| -                     | -         | -         | -         | -         | -         | -         | -         | 41   |
| -                     | -         | -         | -         | -         | -         | -         | -         | 41   |
| BV20SC                | PB20SC    | -         | AS20      | included  | BP20      | -         | -         | 41   |
| BV20SC                | PB20SC    | -         | AS20      | included  | -         | -         | -         | 41   |
| <b>Thread M25x1.5</b> |           |           |           |           |           |           |           |      |
| BV25SC                | PB25SC    | -         | AS25      | included  | BP25      | -         | -         | 42   |
| -                     | -         | -         | AS25      | included  | BP25      | -         | -         | 42   |
| BV25                  | PB25      | SP25      | AS25      | PS25      | -         | -         | PP600     | 42   |
| -                     | -         | -         | -         | -         | -         | -         | PP600     | 42   |
| -                     | -         | -         | -         | -         | -         | -         | -         | 42   |
| -                     | -         | -         | -         | -         | -         | -         | -         | 42   |
| BV25SC                | PB25SC    | -         | AS25      | included  | BP25      | -         | -         | 42   |
| BV25SC                | PB25      | -         | AS25      | included  | -         | -         | -         | 42   |
| -                     | -         | -         | AS25      | included  | BP25      | -         | -         | 42   |

For selection chart, see pages 36 to 37

### M5x0.5

**KM5**  
Locknut

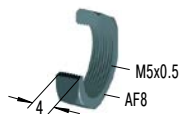

**AH5**  
Stop Collar

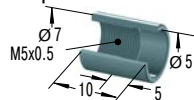

**MB5SC2**  
Mounting Block

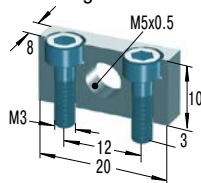

### M6x0.5

**KM6**  
Locknut

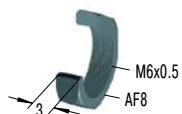

**AH6**  
Stop Collar

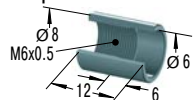

**MB6SC2**  
Mounting Block

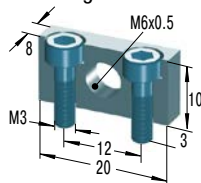

**RF6**  
Rectangular Flange

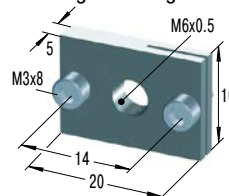

### M8x1

**KM8**  
Locknut

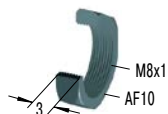

**AH8**  
Stop Collar

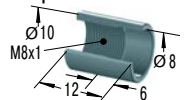

**MB8SC2**  
Mounting Block

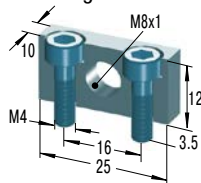

**RF8**  
Rectangular Flange

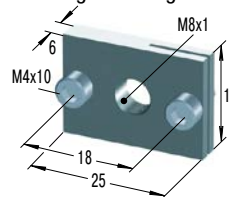

**BV8**  
Side Load Adaptor

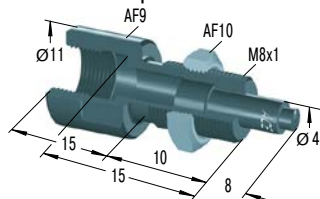

**BV8A**  
Side Load Adaptor

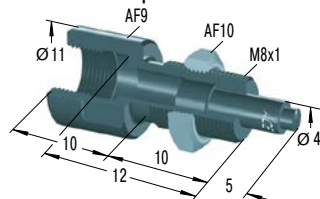

**PB8**  
Steel Shroud

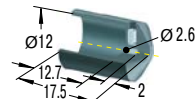

**PB8-A**  
Steel Shroud

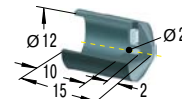

For mounting, installation, ..., see pages 43 to 46.

For selection chart, see pages 36 to 37

### M10x1

**KM10**  
Locknut

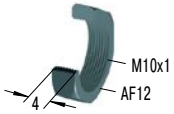

**AH10**  
Stop Collar

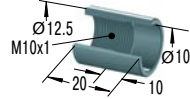

**MB10SC2**  
Mounting Block

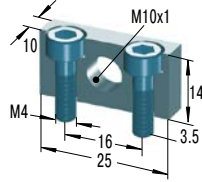

**RF10**  
Rectangular Flange

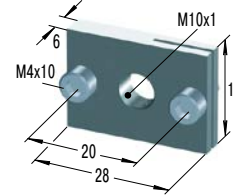

**UM10**  
Universal Mount

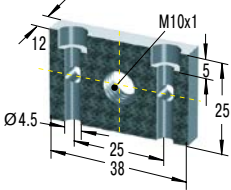

**BV10**  
Side Load Adaptor

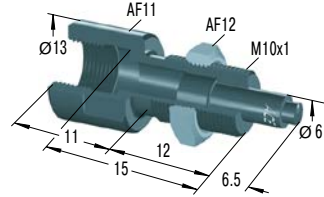

**BV10SC**  
Side Load Adaptor

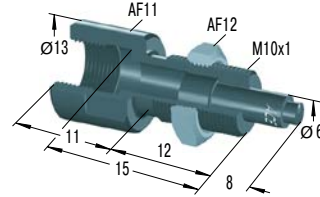

**PB10**  
Steel Shroud

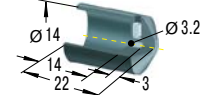

**PB10SC**  
Steel Shroud

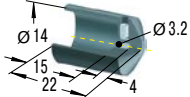

**AS10**  
Switch Stop Collar

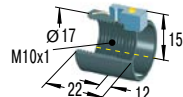

inc. Proximity Switch

**PS10**  
Steel Button

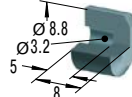

### M12x1

**KM12**  
Locknut

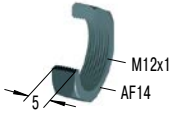

**AH12**  
Stop Collar

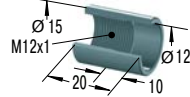

**MB12**  
Clamp Mount

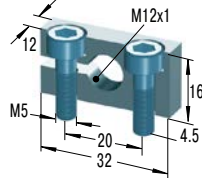

**MB12SC2**  
Mounting Block

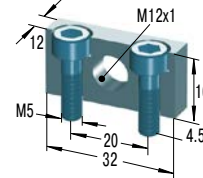

**RF12**  
Rectangular Flange

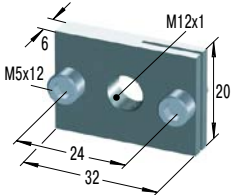

**UM12**  
Universal Mount

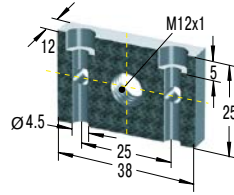

**BV12**  
Side Load Adaptor

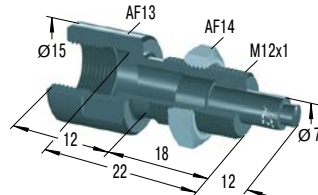

**BV12SC**  
Side Load Adaptor

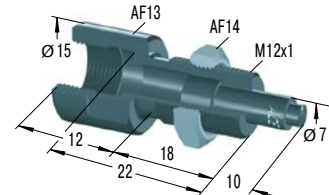

**PB12**  
Steel Shroud

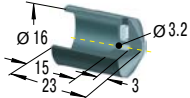

**PB12SC**  
Steel Shroud

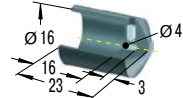

**SP12**  
Air Bleed Collar

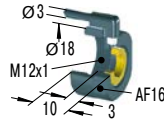

**AS12**  
Switch Stop Collar

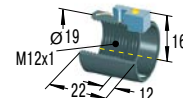

inc. Proximity Switch

**PS12**  
Steel Button

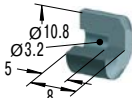

**PS12SC**  
Steel Button

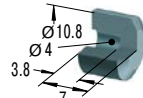

For mounting, installation, .... see pages 43 to 46.

For selection chart, see pages 36 to 37

### M14x1,5

**KM14**  
Locknut

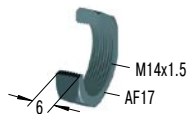

**KM14-V4A**  
Locknut

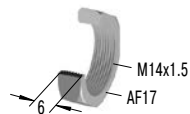

**AH14**  
Stop Collar

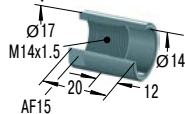

**AH14-V4A**  
Stop Collar

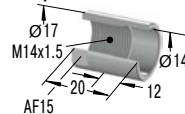

**MB14**  
Clamp Mount

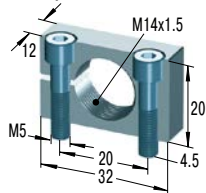

**MB14SC2**  
Mounting Block

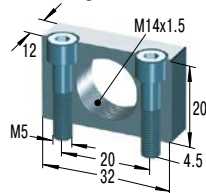

**MB14SC2-V4A**  
Mounting Block

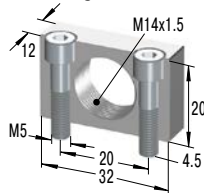

**RF14**  
Rectangular Flange

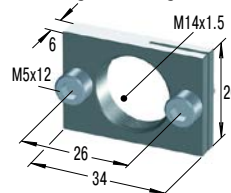

**UM14**  
Universal Mount

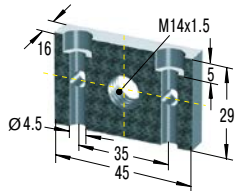

**BV14**  
Side Load Adaptor

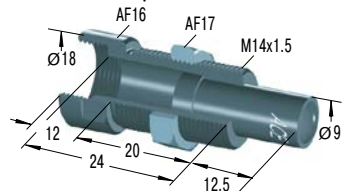

**BV14SC**  
Side Load Adaptor

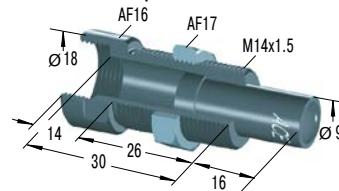

**PB14**  
Steel Shroud

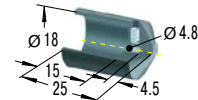

**PB14SC**  
Steel Shroud

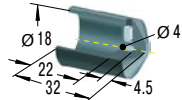

**SP14**  
Air Bleed Collar

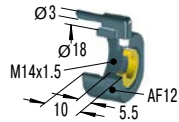

**AS14**  
Switch Stop Collar

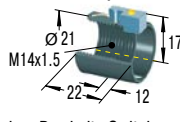

inc. Proximity Switch

**PS14**  
Steel Button

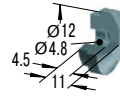

**BP14**  
Steel/Urethane Button

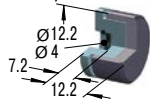

**PP150**  
Nylon Button

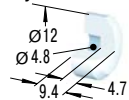

W<sub>3</sub> max = 14 Nm

For mounting, installation, ..., see pages 43 to 46.

For selection chart, see pages 36 to 37

### M20x1.5

**KM20**  
Locknut



**KM20-V4A**  
Locknut

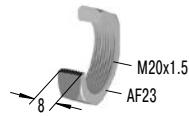

**AH20**  
Stop Collar

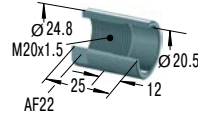

**AH20-V4A**  
Stop Collar

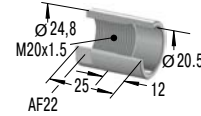

**MB20**  
Clamp Mount

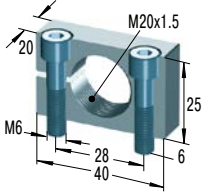

**MB20SC2**  
Mounting Block

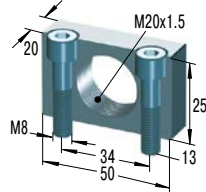

**MB20SC2-V4A**  
Montageblock

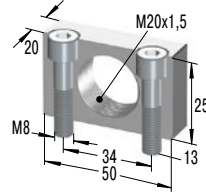

**RF20**  
Rectangular Flange

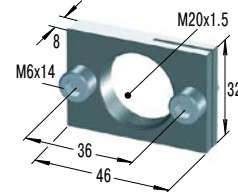

**UM20**  
Universal Mount

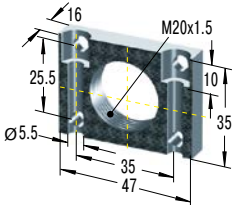

**BV20**  
Side Load Adaptor

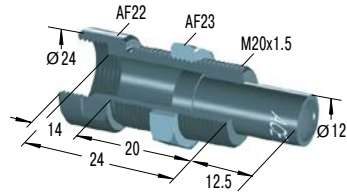

**BV20SC**  
Side Load Adaptor

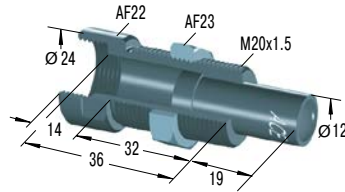

**PB20**  
Steel Shroud

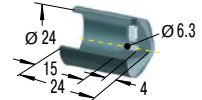

**PB20SC**  
Steel Shroud

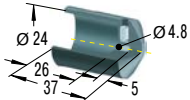

**SP20**  
Air Bleed Collar

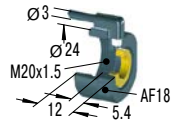

**AS20**  
Switch Stop Collar

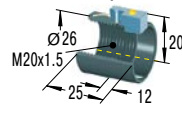

inc. Proximity Switch

**PS20**  
Steel Button

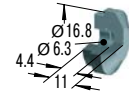

**BP20**  
Steel/Urethane Button

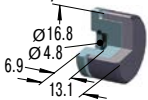

**PP225**  
Nylon Button

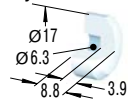

$W_s \text{ max} = 33 \text{ Nm}$

For selection chart, see pages 36 to 37

**M25x1.5**

**KM25**  
Locknut

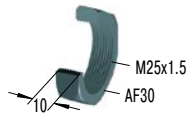

**KM25-V4A**  
Locknut

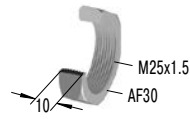

**AH25**  
Stop Collar

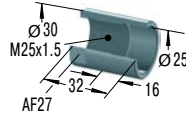

**AH25-V4A**  
Stop Collar

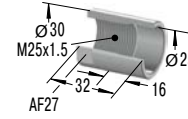

**MB25**  
Clamp Mount

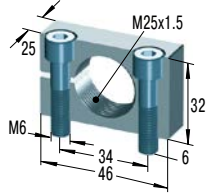

**MB25SC2**  
Mounting Block

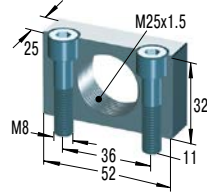

**MB25SC2-V4A**  
Mounting Block

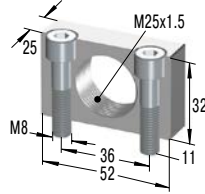

**RF25**  
Rectangular Flange

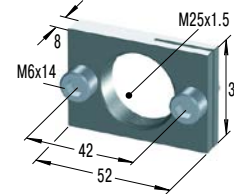

**UM25**  
Universal Mount

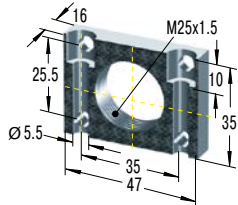

**BV25**  
Side Load Adaptor

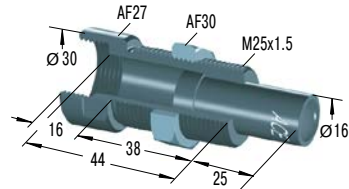

**BV25SC**  
Side Load Adaptor

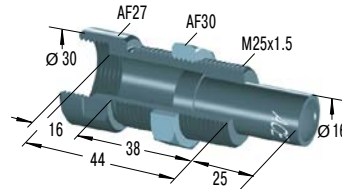

**PB25**  
Steel Shroud

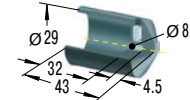

**PB25SC**  
Steel Shroud

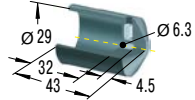

**SP25**  
Air Bleed Collar

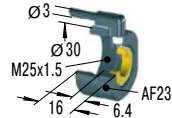

For VC2515FT to VC2555FT  
reduction of the stroke 6.4 mm

**AS25**  
Switch Stop Collar

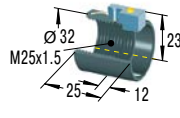

inc. Proximity Switch

**PS25**  
Steel Button

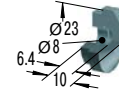

**BP25**  
Steel/Urethane Button

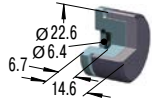

**PP600**  
Nylon Button

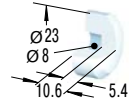

$W_3$  max = 68 Nm

For mounting, installation, ..., see pages 43 to 46.



### AH

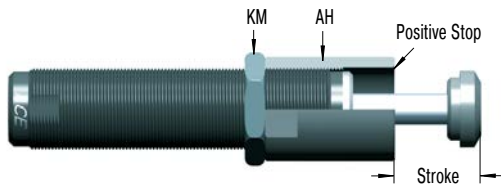

### Stop Collar

All ACE miniature shock absorbers have an integral positive stop. An optional stop collar (AH...) can be added if desired to give fine adjustment of final stopping position.

### MB



### Clamp Mount

When using the MB clamp mount no locknut is needed on the shock absorber (split clamp action). The clamp mount is very compact and allows fine adjustment of the shock absorber position by turning in and out.

#### Safety instructions

When foot mounting the types with combined piston and inner tube SC<sup>2</sup>25EUM to SC<sup>2</sup>650EUM and the types MC5EUM, MC9EUM, MC10EUM, MC30EUM, MC25EUM and MA30EUM, the mounting block MB (SC<sup>2</sup>) must be used.

#### Delivery

Two socket head screws are included with the clamp mount.

#### Dimensions

| TYPES | Screw Size | Max. Torque<br>Nm |
|-------|------------|-------------------|
| MB12  | M5x16      | 6                 |
| MB14  | M5x20      | 6                 |
| MB20  | M6x25      | 11                |
| MB25  | M6x30      | 11                |

### MBSC2



### Mounting Block

The mounting block MB...SC2 ensures the stable fixation of shock absorbers of the SC<sup>2</sup>-Series. Due to the piston tube technology of this series, this mounting block has no clamp slot. The mounting block is also used for types MC5EUM to MC30EUM as well as type MA30EUM.

#### Mounting information

As the MB (SC<sup>2</sup>) has no clamp slot, the shock absorber has to be tightened with the supplied locknut.

#### Delivery

Two socket head screws are included with the clamp mount.

### RF



### Rectangular Flange

The rectangular flange RF provides a space saving convenient assembly and does not need a lock nut to hold the shock absorber. Therefore achieving a neat, compact and flat surface mounting.

#### Dimensions

| TYPES | Screw Size | Max. Torque<br>Nm |
|-------|------------|-------------------|
| RF6   | M3x8       | 3                 |
| RF8   | M4x10      | 4                 |
| RF10  | M4x10      | 4                 |
| RF12  | M5x12      | 6                 |
| RF14  | M5x12      | 6                 |
| RF20  | M6x14      | 11                |
| RF25  | M6x14      | 11                |

**PB**

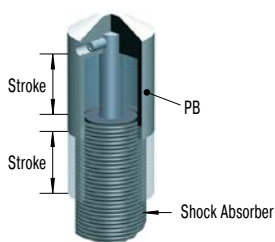

**Steel Shroud**

Grinding beads, sand, welding splatter, paints and adhesives etc. can adhere to the piston rod. They then damage the rod seals and the shock absorber quickly fails. In many cases the installation of the optional steel shroud can provide worthwhile protection and increase lifetime.

**Ordering information**

The PB steel shroud can only be installed onto a shock absorber without rod end button.

For part number MA, MC, SC please order with "M-880" suffix. Part numbers MA150EUM, MC150EUM to MC600EUM and SC25EUM to SC190EUM5-7 are supplied without a button.

**Safety instructions**

When installing don't forget to allow operating space for the shroud to move as the shock absorber is cycled.

**SP**

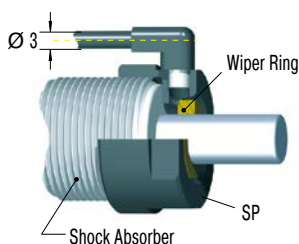

**Air Bleed Collar**

Air bleed collar (includes integral stop collar) protects shock absorber from ingress of abrasive contaminants like cement, paper or wood dust into the rod seal area. It also prevents aggressive fluids such as cutting oils, coolants etc. damaging the seals. Air bleed supply 0.5 to 1 bar. Low air consumption. The constant air bleed prevents contaminants passing the wiper ring and entering the shock absorber seal area.

**Safety instructions**

Do not switch off air supply whilst machine is operating! The air bleed collar cannot be used on all similar body thread sized shock absorbers. The air bleed collar is only for types MC150EUM to MC600EUM, MA150EUM, SC75EUM and SC190EUM5-7.

**PP**

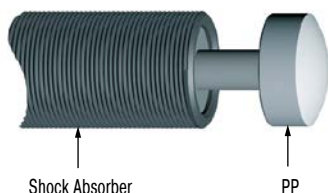

**Nylon Button**

While the use of industrial shock absorbers already achieves a considerable reduction in noise levels, the additional use of PP impact buttons made of glass fibre reinforced nylon reduces noise levels even further, making it easy to fulfil the regulations of the new Noise Control Ordinance. At the same time, wear of impact surface is drastically minimized. The PP buttons are available for shock absorbers in series MC150EUM to MC600EUM.

**Mounting information**

The buttons are fitted simply by pressing onto the piston rod. We recommend to additionally fix the nylon button with LOCTITE.

**Delivery**

Model MA150EUM is supplied as standard with PP button.

**BP**

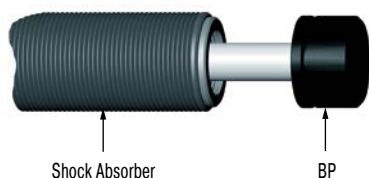

**Steel/Urethane Button**

These impact buttons made of urethane offer all above advantages of the PP nylon button in terms of reducing noise and wear. They fit easily onto the piston rod of the corresponding shock absorber. BP buttons must additionally be secured with LOCTITE.

Please refer to the accessories table on pages 36 to 37 to see which shock absorber types the BP buttons are available for.

### BV

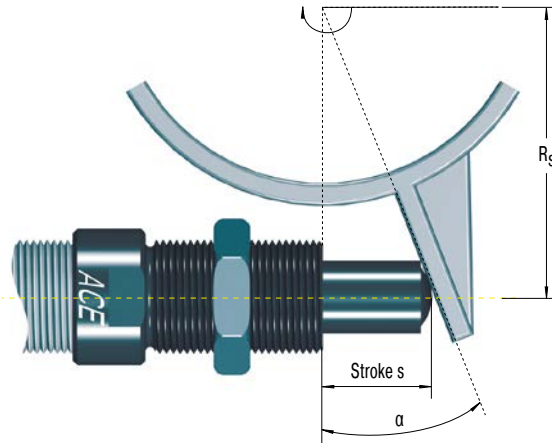
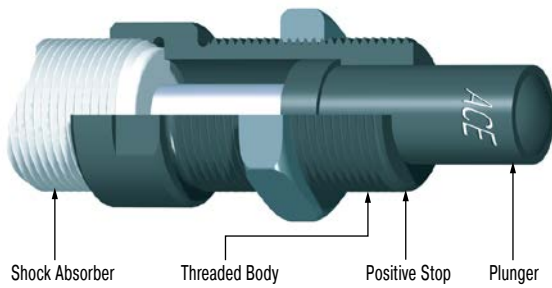

#### Formulae:

$$\alpha = \tan^{-1} \left( \frac{s}{R_s} \right) \quad R_{s \min} = \frac{s}{\tan \alpha \max}$$

#### Example:

$$s = 0.025 \text{ m} \quad \alpha \max = 25^\circ \text{ (Type BV25)}$$

$$R_s = 0.1 \text{ m}$$

$$\alpha = \tan^{-1} \left( \frac{0.025}{0.1} \right) \quad R_{s \min} = \frac{0.025}{\tan 25}$$

$$\alpha = 14.04^\circ \quad R_{s \min} = 0.054 \text{ m}$$

|               |                     |              |                                   |
|---------------|---------------------|--------------|-----------------------------------|
| $\alpha$      | = side load angle ° | $R_s$        | = mounting radius m               |
| $\alpha \max$ | = max. angle °      | $R_{s \min}$ | = min. possible mounting radius m |
| s             | = absorber stroke m |              |                                   |

### Side Load Adaptor

Rotating impact motion causes high side load forces on the piston rod. This increases bearing wear and possibly results in rod breakage or bending. With side load impact angles of more than 3° the operation lifetime of the shock absorber reduces rapidly due to increased wear of the rod bearings. The optional BV side load adaptor provides long lasting solution.

#### Ordering information

The BV adaptor can only be installed onto a shock absorber without rod end button.

Part Number: MA, MC, SC...-880 (Models MC150EUM to MC600EUM and SC<sup>2</sup>25EUM to SC<sup>2</sup>190EUM5-7 are supplied as standard without buttons.)

#### Material

Threaded body and plunger: Hardened high tensile steel, hardened 610 HV1

#### Mounting information

Secure the side load adaptor with LOCTITE or locknut on the shock absorber.

For material combination plunger/impact plate use similar hardness values. We recommend that you install the shock absorber/side load adaptor using the thread on the side load adaptor.

Installation with clamp mount MB... not possible. Use mounting block MB... SC<sup>2</sup>!

#### Safety instructions

Maximum angle:

BV8, BV10 and BV12 = 12.5°

BV14, BV20 and BV25 = 25°

By repositioning the centre of the stroke of the side load plunger to be at 90 degrees to the piston rod, the side load angle can be halved. The use of an external positive stop due to high forces encountered is required.

**AS**

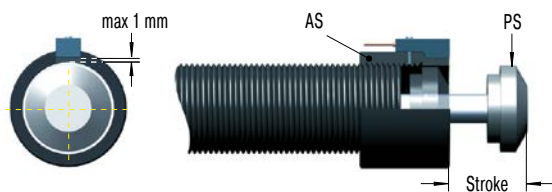

**Switch Stop Collar**

The ACE stop light switch stop collar combination AS, incl. proximity switch PNP, can be mounted on all popular shock absorber models. The use of the steel button PS is mandatory.

Advantages: Very short, compact mounting package, good price-performance ratio, retrofit possible for standard shock absorber models, fine adjustment of the stroke possible.

**Ordering information**

The steel button type PS is fitted as standard on the models: SC190EUM0-4, SC300EUM0-9, SC650EUM0-9, SC925EUM0-4, MA/MVC225EUM, MA/MVC600EUM and MA/MVC900EUM. With all other models you must order the PS button as an optional accessory.

**Mounting information**

We recommend to fix the steel button onto the end of the piston rod using LOCTITE 290. Attention! Take care not to leave any adhesive on the piston rod as this will cause seal damage. Thread the switch stop collar onto the front of the shock absorber and secure in position. Switch cable should not be routed close to power cables.

**250-3 PNP**

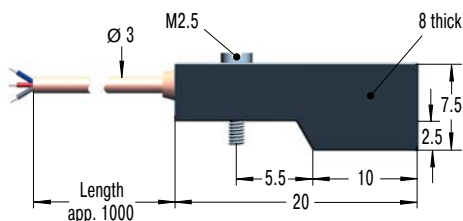

**Proximity Switch**

The proximity switch is part of the ACE stop light switch collar combination. The correct starting position can thus be checked electronically.

**Ordering information**

Part number: 250-3 PNP

**PNP proximity switch data**

- Supply voltage: 10-27 VDC
- Ripple: < 10 %
- Load current max.: 100 mA
- Operating temperature range: -10 °C to +60 °C
- Residual voltage: max. 1 V
- Protection: IP67 (IEC 144) with LED-indicator
- Proximity switch N/Open when shock absorber extended.
- When shock absorber is fully compressed switch closes and LED indicator lights.

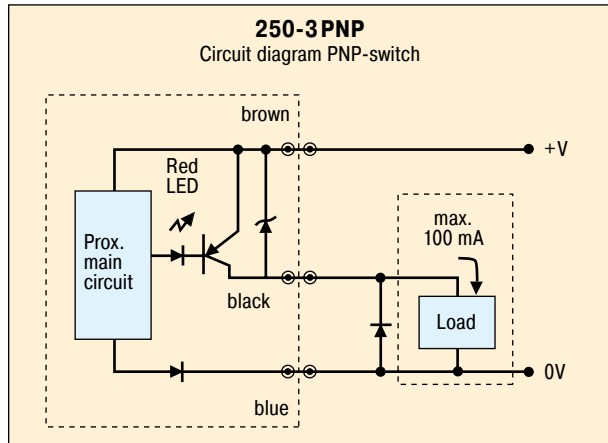

# High Performance

## for PET Stretch Blow Machines

**NEW**



## PET 20 and PET 27

**20 million cycles – up to 107 °C – aluminium outer body  
hardened pressure chamber – corrosion protection**

=

extended service life – low-wear – faster  
reduced downtime – improved system performance  
increased production volume – high cost efficiency

For all information see our Website [www.ace-ace.com](http://www.ace-ace.com)



# Application Examples

## MC25EUM

### Constant deceleration force

ACE miniature shock absorbers are the right alternative. This pneumatic module for high precision, high speed motion intentionally abandoned pneumatic end-of-travel damping. The compact miniature shock absorbers of the type MC25EUMH-NB decelerate the linear motion safer and faster when reaching the end-of-travel position. They accept the moving load gently and decelerate it smoothly throughout the entire stroke length. Additional advantages: simpler construction, smaller pneumatic valves, lower maintenance costs as well as reduced compressed air consumption.

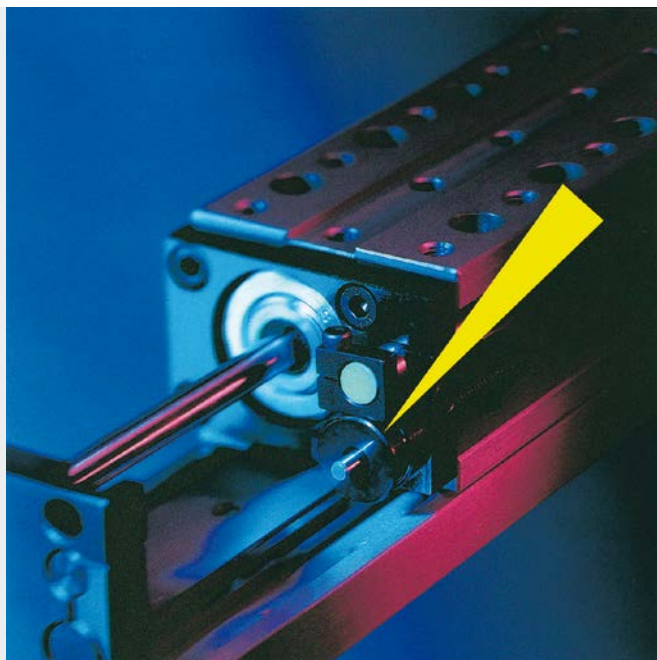
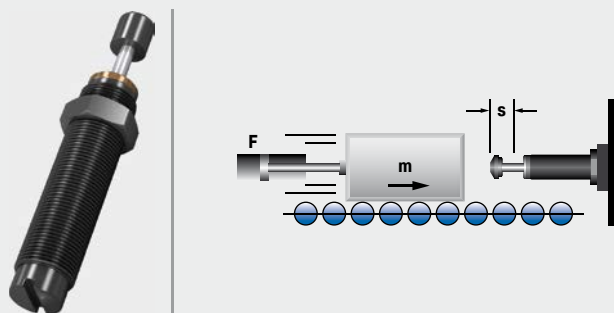

Miniature Shock Absorber in compact pneumatic module

## MC225EUM

### Obstacle end positions secured

In the case of driving safety training, swinging flags are used to simulate the sudden appearance of obstacles. If the driver reacts too slowly, the flags are swung just as quickly away to avoid damage to the vehicle. In order to protect the end positions of this safety system during to and fro motion, ACE miniature shock absorbers of the type MC225EUMH2 are installed. They come with a special side load adapter for use in this situation. Among other things, this improves the ability of the shock absorber to absorb lateral forces during to and fro motion.

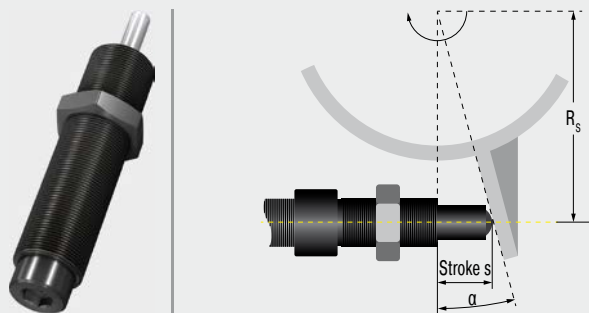

Miniature shock absorbers protect the end positions during driving safety training

Dorning Hytronics GmbH, 4210 Unterweikersdorf, Austria

### SC190EUM

#### Soft end-of-travel damping on rotary movements

ACE miniature shock absorbers optimize production with minimum expenditure. The cycle rate for an assembly line producing electronic components was increased to 3,600 units/hr. Miniature shock absorbers type SC190EUM-1 decelerate the rapid transfer movements on the production line and using soft damping methods optimize the pick up and set down of components. This soft deceleration technique has increased production and reduced maintenance on the portal and rotary actuator modules. The optional side load adaptor protects the shock absorber from high side load forces and increases the operating lifetime. Using ACE shock absorbers reduces maintenance costs by 50 % and running costs by 20 %, diminishing energy consumption.

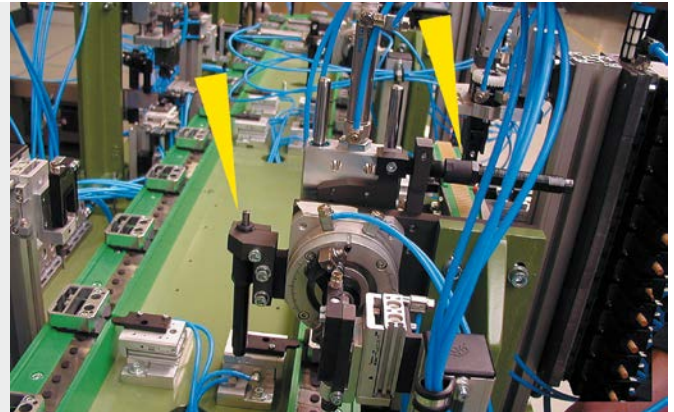

Optimised production in the electronics industry  
Stebie Maschinenbau GmbH, Germany

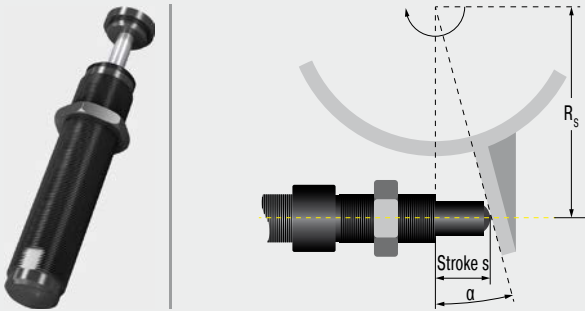



# Industrial Shock Absorbers

## Absorbers to suit – for all loads

**ACE industrial shock absorbers work hard. Their application means moving loads are evenly decelerated over the full stroke. The result: the lowest braking force and shortest braking time. The MAGNUM series from ACE is viewed as the reference standard for medium design sizes in damping technology.**

Innovations such as diaphragm accumulators, seals, tube-shaped inner pressure chambers and many more make a decisive contribution towards extension of the service life. This means that the effective load range can be extended considerably, which provides users with more scope with respect to the absorber size and utilisation of the machine's output. ACE offers a wide range of matching accessories for this and all other absorber series. This eliminates internal production of assembly parts, which involves high costs and lots of time.

Innovative damping techniques

Reference class for medium sizes

Less stress on the machine

Increase of production figures

Long machine service lives



## Industrial Shock Absorbers



### MC33 to MC64

Page 52

Self-Compensating

**High energy absorption and robust design**

Linear slides, Swivel units, Turntables, Portal systems



### MC33-V4A to MC64-V4A

Page 56

self-Compensating, stainless Steel

**Optimum corrosion protection**

Linear slides, Swivel units, Turntables, Food industry



### MC33-HT to MC64-HT

Page 60

Self-Compensating

**Extreme temperatures and high cycle frequencies**

Linear slides, Swivel units, Turntables, Machines and plants



### MC33-LT to MC64-LT

Page 64

Self-Compensating

**Extreme temperatures and high cycle frequencies**

Linear slides, Swivel units, Turntables, Machines and plants



### SC33 to SC45

Page 68

Self-Compensating, Piston Tube Technology

**Piston tube design for maximum energy absorption**

Turntables, Swivel units, Robot arms, Linear slides



### MA/ML33 to MA/ML64

Page 70

Adjustable

**High energy absorption and progressive adjustment**

Linear slides, Swivel units, Turntables, Portal systems

## MC33 to MC64

### High energy absorption and robust design

#### Self-Compensating

**Energy capacity 170 Nm/Cycle to 5,650 Nm/Cycle**

**Stroke 23.1 mm to 150 mm**

The latest damper technology: The combination of the latest sealing technology, annealed guide bearing and integrated positiv stop make these self-compensating shock absorbers from ACE'S MAGNUM range so successful. After all, users benefit from the longer service life of the products, even in the most difficult environments. A continuous outer thread and extensive accessories make their contribution to the success story of the MC33 to MC64.

High energy absorption in a compact design and a wide damping range lead to huge advantages in practice. Alongside generally more compact designs, these small yet very powerful absorbers enable full use of the machine's performance.

These self-compensating industrial shock absorbers are used in all areas of mechanical engineering – especially in automation and for gantries.

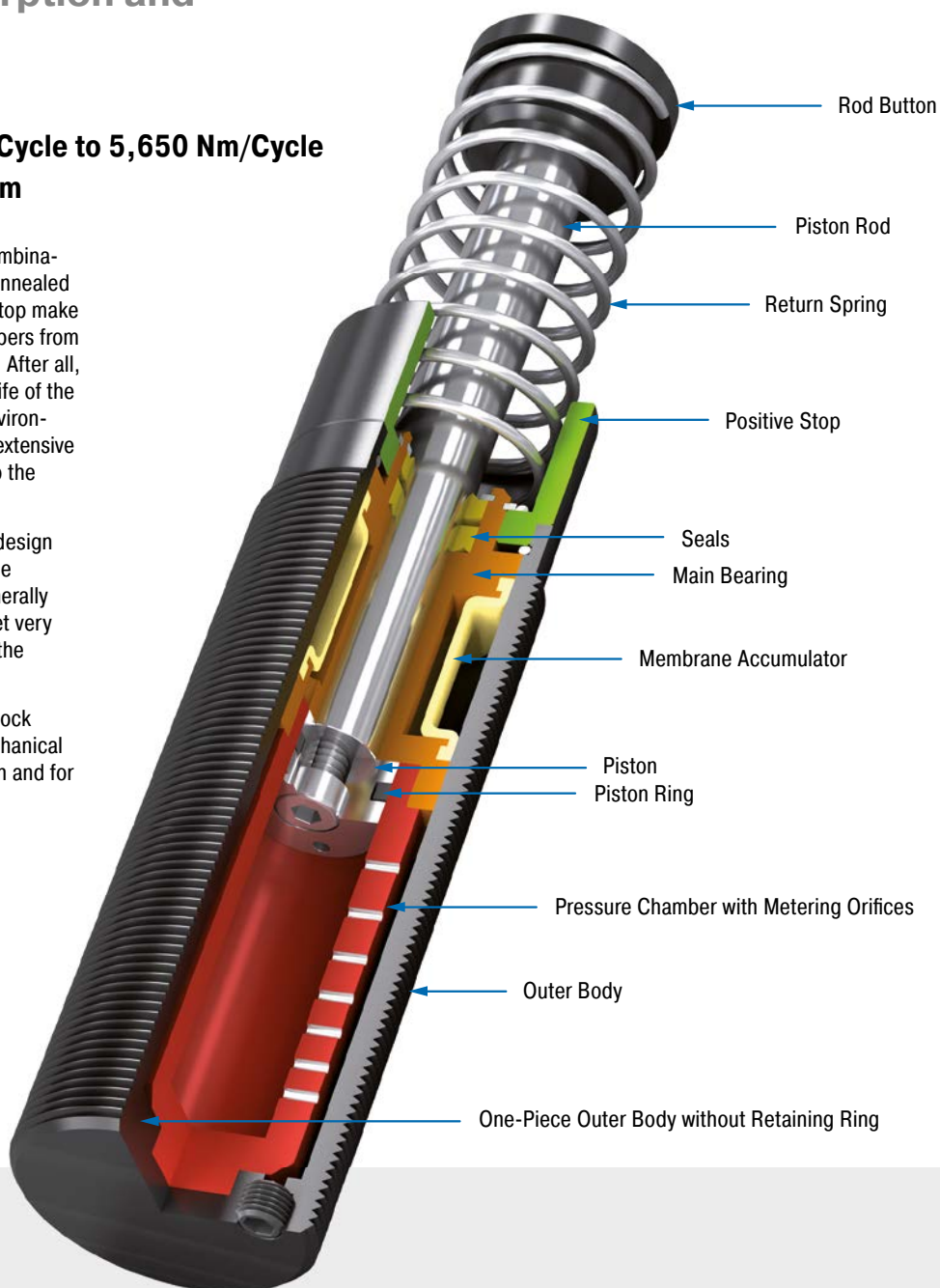

#### Technical Data

**Energy capacity:** 170 Nm/Cycle to 5,650 Nm/Cycle

**Impact velocity range:** 0.15 m/s to 5 m/s. Other speeds on request.

**Operating temperature range:** -12 °C to +66 °C. Other temperatures on request.

**Mounting:** In any position

**Positive stop:** Integrated

**Material:** Outer body: Nitride hardened steel; Piston rod: Hard chrome plated steel; Rod end button: Hardened steel and corrosion-resistant coating; Return spring: Zinc plated or plastic-coated steel; Accessories: Steel with black oxide finish or nitride hardened

**Damping medium:** Automatic Transmission Fluid (ATF)

**Application field:** Linear slides, Swivel units, Turntables, Portal systems, Machines and plants, Tool machines, Machining centres, Z-axes, Impact panels

**Note:** A noise reduction of 3 to 7 dB is possible when using the special impact button (PP). For emergency use only applications and for continuous use (with additional cooling) it is sometimes possible to exceed the published max. capacity ratings. In this case, please consult ACE.

**Safety instructions:** External materials in the surrounding area can attack the seal compo-

nents and lead to a shorter service life. Please contact ACE for appropriate solution suggestions. Do not paint the shock absorbers due to heat emission.

**On request:** Special oils, nickel-plated, increased corrosion protection, mounting inside air cylinders or other special options are available on request.

### MC33EUM

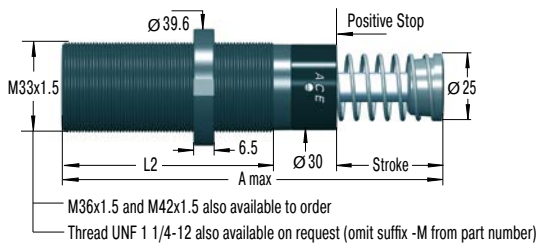

### NM33 Locking Ring

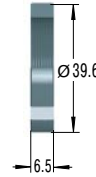

### QF33 Square Flange

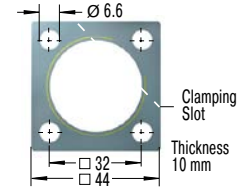

Torque max.: 11 Nm  
Clamping torque: > 90 Nm  
Install with 4 machine screws

The calculation and selection of the most suitable damper should be carried out or be approved by ACE.

### Model Type Prefix

#### Standard Models

MC: Self-Contained with return spring, self-compensating

#### Special Models

MCA: Air/Oil return without return spring.

Use only with external air/oil tank.

MCS: Air/Oil return with return spring.

Use only with external air/oil tank.

MCN: Self-Contained without return spring

### Ordering Example

**MC3325EUM-1**

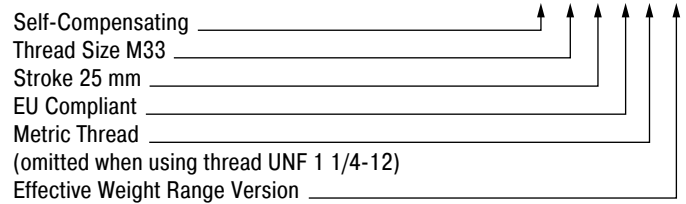

### Dimensions

| TYPES     | Stroke<br>mm | A max.<br>mm | L2<br>mm |
|-----------|--------------|--------------|----------|
| MC3325EUM | 23.2         | 138          | 83       |
| MC3350EUM | 48.6         | 189          | 108      |

### Performance

| TYPES       | Max. Energy Capacity                    |                        |   |  | Effective Weight           |                            |          | Return Force<br>min.<br>N | Return Force<br>max.<br>N | Return Time<br>s | Side Load Angle<br>max.<br>° | Weight<br>kg |
|-------------|---|------------------------|---|--|----------------------------|----------------------------|----------|---------------------------|---------------------------|------------------|------------------------------|--------------|
|             | <sup>1</sup> W <sub>3</sub><br>Nm/cycle | W <sub>4</sub><br>Nm/h | W <sub>4</sub> with<br>Air/Oil Tank<br>Nm/h | W <sub>4</sub> with Oil<br>Recirculation<br>Nm/h | <sup>2</sup> me min.<br>kg | <sup>2</sup> me max.<br>kg | Hardness |                           |                           |                  |                              |              |
| MC3325EUM-0 | 170                                     | 75,000                 | 124,000                                     | 169,000  | 3                          | 11                         | -0       | 45                        | 90                        | 0.03             | 4                            | 0.51         |
| MC3325EUM-1 | 170                                     | 75,000                 | 124,000                                     | 169,000  | 9                          | 40                         | -1       | 45                        | 90                        | 0.03             | 4                            | 0.51         |
| MC3325EUM-2 | 170                                     | 75,000                 | 124,000                                     | 169,000  | 30                         | 120                        | -2       | 45                        | 90                        | 0.03             | 4                            | 0.51         |
| MC3325EUM-3 | 170                                     | 75,000                 | 124,000                                     | 169,000  | 100                        | 420                        | -3       | 45                        | 90                        | 0.03             | 4                            | 0.51         |
| MC3325EUM-4 | 170                                     | 75,000                 | 124,000                                     | 169,000  | 350                        | 1,420                      | -4       | 45                        | 90                        | 0.03             | 4                            | 0.51         |
| MC3350EUM-0 | 330                                     | 85,000                 | 135,000                                     | 180,000  | 5                          | 22                         | -0       | 45                        | 135                       | 0.06             | 3                            | 0.63         |
| MC3350EUM-1 | 330                                     | 85,000                 | 135,000                                     | 180,000  | 18                         | 70                         | -1       | 45                        | 135                       | 0.06             | 3                            | 0.63         |
| MC3350EUM-2 | 330                                     | 85,000                 | 135,000                                     | 180,000  | 60                         | 250                        | -2       | 45                        | 135                       | 0.06             | 3                            | 0.63         |
| MC3350EUM-3 | 330                                     | 85,000                 | 135,000                                     | 180,000  | 210                        | 840                        | -3       | 45                        | 135                       | 0.06             | 3                            | 0.63         |
| MC3350EUM-4 | 330                                     | 85,000                 | 135,000                                     | 180,000  | 710                        | 2,830                      | -4       | 45                        | 135                       | 0.06             | 3                            | 0.63         |

<sup>1</sup> For emergency use only applications it is sometimes possible to exceed the above ratings. Please consult ACE for further details.

<sup>2</sup> The effective weight range limits can be raised or lowered to special order.

<sup>3</sup> For applications with higher side load angles consider using the side load adaptor (BV) pages 74 to 77.

Self-Compensating

**MC45EUM**

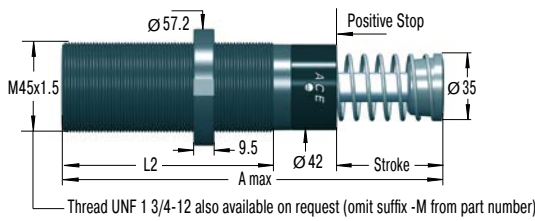

**NM45**  
Locking Ring

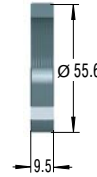

**QF45**  
Square Flange

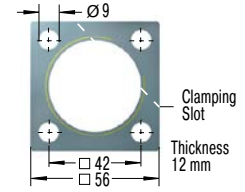

Torque max.: 27 Nm  
Clamping torque: > 200 Nm  
Install with 4 machine screws

The calculation and selection of the most suitable damper should be carried out or be approved by ACE.

**Model Type Prefix**

**Standard Models**

MC: Self-Contained with return spring, self-compensating

**Special Models**

MCA: Air/Oil return without return spring.  
Use only with external air/oil tank.

MCS: Air/Oil return with return spring.  
Use only with external air/oil tank.

MCN: Self-Contained without return spring

**Ordering Example**

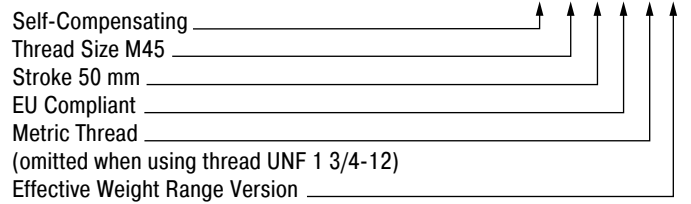

**Dimensions**

| TYPES     | Stroke<br>mm | A max.<br>mm | L2<br>mm |
|-----------|--------------|--------------|----------|
| MC4525EUM | 23.1         | 145          | 95       |
| MC4550EUM | 48.5         | 195          | 120      |
| MC4575EUM | 73.9         | 246          | 145      |

**Performance**

| TYPES       | Max. Energy Capacity                    |                        |   |  | Effective Weight           |                            |          | Return Force<br>min.<br>N | Return Force<br>max.<br>N | Return Time<br>s | Side Load Angle<br>max.<br>° | Weight<br>kg |
|-------------|---|------------------------|---|--|----------------------------|----------------------------|----------|---------------------------|---------------------------|------------------|------------------------------|--------------|
|             | <sup>1</sup> W <sub>3</sub><br>Nm/cycle | W <sub>4</sub><br>Nm/h | W <sub>4</sub> with<br>Air/Oil Tank<br>Nm/h | W <sub>4</sub> with Oil<br>Recirculation<br>Nm/h | <sup>2</sup> me min.<br>kg | <sup>2</sup> me max.<br>kg | Hardness |                           |                           |                  |                              |              |
| MC4525EUM-0 | 370                                     | 107,000                | 158,000                                     | 192,000  | 7                          | 27                         | -0       | 70                        | 100                       | 0.03             | 4                            | 1.14         |
| MC4525EUM-1 | 370                                     | 107,000                | 158,000                                     | 192,000  | 20                         | 90                         | -1       | 70                        | 100                       | 0.03             | 4                            | 1.14         |
| MC4525EUM-2 | 370                                     | 107,000                | 158,000                                     | 192,000  | 80                         | 310                        | -2       | 70                        | 100                       | 0.03             | 4                            | 1.14         |
| MC4525EUM-3 | 370                                     | 107,000                | 158,000                                     | 192,000  | 260                        | 1,050                      | -3       | 70                        | 100                       | 0.03             | 4                            | 1.14         |
| MC4525EUM-4 | 370                                     | 107,000                | 158,000                                     | 192,000  | 890                        | 3,540                      | -4       | 70                        | 100                       | 0.03             | 4                            | 1.14         |
| MC4550EUM-0 | 740                                     | 112,000                | 192,000                                     | 248,000  | 13                         | 54                         | -0       | 70                        | 145                       | 0.08             | 3                            | 1.36         |
| MC4550EUM-1 | 740                                     | 112,000                | 192,000                                     | 248,000  | 45                         | 180                        | -1       | 70                        | 145                       | 0.08             | 3                            | 1.36         |
| MC4550EUM-2 | 740                                     | 112,000                | 192,000                                     | 248,000  | 150                        | 620                        | -2       | 70                        | 145                       | 0.08             | 3                            | 1.36         |
| MC4550EUM-3 | 740                                     | 112,000                | 192,000                                     | 248,000  | 520                        | 2,090                      | -3       | 70                        | 145                       | 0.08             | 3                            | 1.36         |
| MC4550EUM-4 | 740                                     | 112,000                | 192,000                                     | 248,000  | 1,800                      | 7,100                      | -4       | 70                        | 145                       | 0.08             | 3                            | 1.36         |
| MC4575EUM-0 | 1,130                                   | 146,000                | 225,000                                     | 282,000  | 20                         | 80                         | -0       | 50                        | 180                       | 0.11             | 2                            | 1.59         |
| MC4575EUM-1 | 1,130                                   | 146,000                | 225,000                                     | 282,000  | 70                         | 270                        | -1       | 50                        | 180                       | 0.11             | 2                            | 1.59         |
| MC4575EUM-2 | 1,130                                   | 146,000                | 225,000                                     | 282,000  | 230                        | 930                        | -2       | 50                        | 180                       | 0.11             | 2                            | 1.59         |
| MC4575EUM-3 | 1,130                                   | 146,000                | 225,000                                     | 282,000  | 790                        | 3,140                      | -3       | 50                        | 180                       | 0.11             | 2                            | 1.59         |
| MC4575EUM-4 | 1,130                                   | 146,000                | 225,000                                     | 282,000  | 2,650                      | 10,600                     | -4       | 50                        | 180                       | 0.11             | 2                            | 1.59         |

<sup>1</sup> For emergency use only applications it is sometimes possible to exceed the above ratings. Please consult ACE for further details.

<sup>2</sup> The effective weight range limits can be raised or lowered to special order.

<sup>3</sup> For applications with higher side load angles consider using the side load adaptor (BV) pages 74 to 77.

### MC64EUM

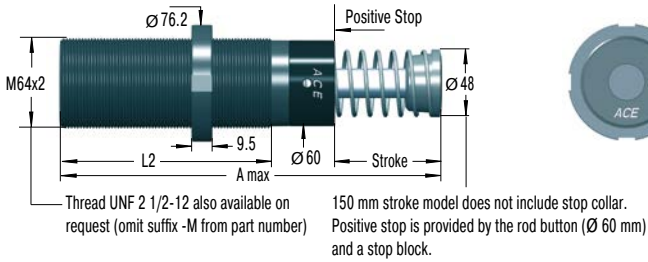

### NM64 Locking Ring

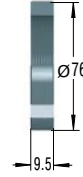

### QF64 Square Flange

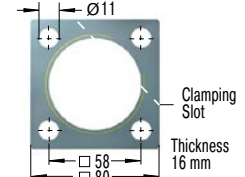

Torque max.: 50 Nm  
Clamping torque: > 210 Nm  
Install with 4 machine screws

The calculation and selection of the most suitable damper should be carried out or be approved by ACE.

### Model Type Prefix

#### Standard Models

MC: Self-Contained with return spring, self-compensating

#### Special Models

MCA: Air/Oil return without return spring.

Use only with external air/oil tank.

MCS: Air/Oil return with return spring.

Use only with external air/oil tank.

MCN: Self-Contained without return spring

### Ordering Example

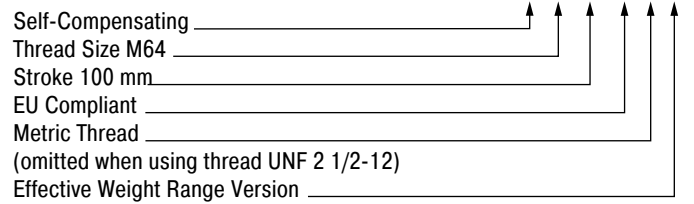

### Dimensions

| TYPES      | Stroke<br>mm | A max.<br>mm | L2<br>mm |
|------------|--------------|--------------|----------|
| MC6450EUM  | 48.6         | 225          | 140      |
| MC64100EUM | 99.4         | 326          | 191      |
| MC64150EUM | 150          | 450          | 241      |

### Performance

| TYPES        | Max. Energy Capacity                    |                        |   |  | Effective Weight           |                            |          | Return Force<br>min.<br>N | Return Force<br>max.<br>N | Return Time<br>s | Side Load Angle<br>max.<br>° | Weight<br>kg |
|--------------|---|------------------------|---|--|----------------------------|----------------------------|----------|---------------------------|---------------------------|------------------|------------------------------|--------------|
|              | <sup>1</sup> W <sub>3</sub><br>Nm/cycle | W <sub>4</sub><br>Nm/h | W <sub>4</sub> with<br>Air/Oil Tank<br>Nm/h | W <sub>4</sub> with Oil<br>Recirculation<br>Nm/h | <sup>2</sup> me min.<br>kg | <sup>2</sup> me max.<br>kg | Hardness |                           |                           |                  |                              |              |
| MC6450EUM-0  | 1,870                                   | 146,000                | 293,000                                     | 384,000  | 35                         | 140                        | -0       | 90                        | 155                       | 0.12             | 4                            | 2.9          |
| MC6450EUM-1  | 1,870                                   | 146,000                | 293,000                                     | 384,000  | 140                        | 540                        | -1       | 90                        | 155                       | 0.12             | 4                            | 2.9          |
| MC6450EUM-2  | 1,870                                   | 146,000                | 293,000                                     | 384,000  | 460                        | 1,850                      | -2       | 90                        | 155                       | 0.12             | 4                            | 2.9          |
| MC6450EUM-3  | 1,870                                   | 146,000                | 293,000                                     | 384,000  | 1,600                      | 6,300                      | -3       | 90                        | 155                       | 0.12             | 4                            | 2.9          |
| MC6450EUM-4  | 1,870                                   | 146,000                | 293,000                                     | 384,000  | 5,300                      | 21,200                     | -4       | 90                        | 155                       | 0.12             | 4                            | 2.9          |
| MC64100EUM-0 | 3,730                                   | 192,000                | 384,000                                     | 497,000  | 70                         | 280                        | -0       | 105                       | 270                       | 0.34             | 3                            | 3.7          |
| MC64100EUM-1 | 3,730                                   | 192,000                | 384,000                                     | 497,000  | 270                        | 1,100                      | -1       | 105                       | 270                       | 0.34             | 3                            | 3.7          |
| MC64100EUM-2 | 3,730                                   | 192,000                | 384,000                                     | 497,000  | 930                        | 3,700                      | -2       | 105                       | 270                       | 0.34             | 3                            | 3.7          |
| MC64100EUM-3 | 3,730                                   | 192,000                | 384,000                                     | 497,000  | 3,150                      | 12,600                     | -3       | 105                       | 270                       | 0.34             | 3                            | 3.7          |
| MC64100EUM-4 | 3,730                                   | 192,000                | 384,000                                     | 497,000  | 10,600                     | 42,500                     | -4       | 105                       | 270                       | 0.34             | 3                            | 3.7          |
| MC64150EUM-0 | 5,650                                   | 248,000                | 497,000                                     | 644,000  | 100                        | 460                        | -0       | 75                        | 365                       | 0.48             | 2                            | 5.1          |
| MC64150EUM-1 | 5,650                                   | 248,000                | 497,000                                     | 644,000  | 410                        | 1,640                      | -1       | 75                        | 365                       | 0.48             | 2                            | 5.1          |
| MC64150EUM-2 | 5,650                                   | 248,000                | 497,000                                     | 644,000  | 1,390                      | 5,600                      | -2       | 75                        | 365                       | 0.48             | 2                            | 5.1          |
| MC64150EUM-3 | 5,650                                   | 248,000                | 497,000                                     | 644,000  | 4,700                      | 18,800                     | -3       | 75                        | 365                       | 0.48             | 2                            | 5.1          |
| MC64150EUM-4 | 5,650                                   | 248,000                | 497,000                                     | 644,000  | 16,000                     | 63,700                     | -4       | 75                        | 365                       | 0.48             | 2                            | 5.1          |

<sup>1</sup> For emergency use only applications it is sometimes possible to exceed the above ratings. Please consult ACE for further details.

<sup>2</sup> The effective weight range limits can be raised or lowered to special order.

<sup>3</sup> For applications with higher side load angles consider using the side load adaptor (BV) pages 74 to 77.



## MC33-V4A to MC64-V4A

### Optimum corrosion protection

#### self-Compensating, stainless Steel

**Energy capacity 170 Nm/Cycle to 3,730 Nm/Cycle**

**Stroke 23.1 mm to 99.4 mm**

The latest damper technology in stainless steel: The self-compensating industrial shock absorbers MC33 to MC64 from the tried-and-tested and popular MAGNUM range is also available with all outer components made from stainless steel, material 1.4404 (except piston rod). They are filled in the factory with special oil, which meets the permit conditions (NSF-H1) for the food industry.

Just like the standard product family, the MAGNUM stainless steel models are distinguished by their robust, modern sealing technology, high energy absorption in a compact design, integrated positive stop and a wide damping range. Equipped with a PU head, they are available in thread sizes M33x1.5 to M64x2 with damping strokes up to 100 mm.

These self-compensating industrial shock absorbers made of stainless steel from ACE are mainly used in the food, medical, electro and offshore industries, but also in many other markets.

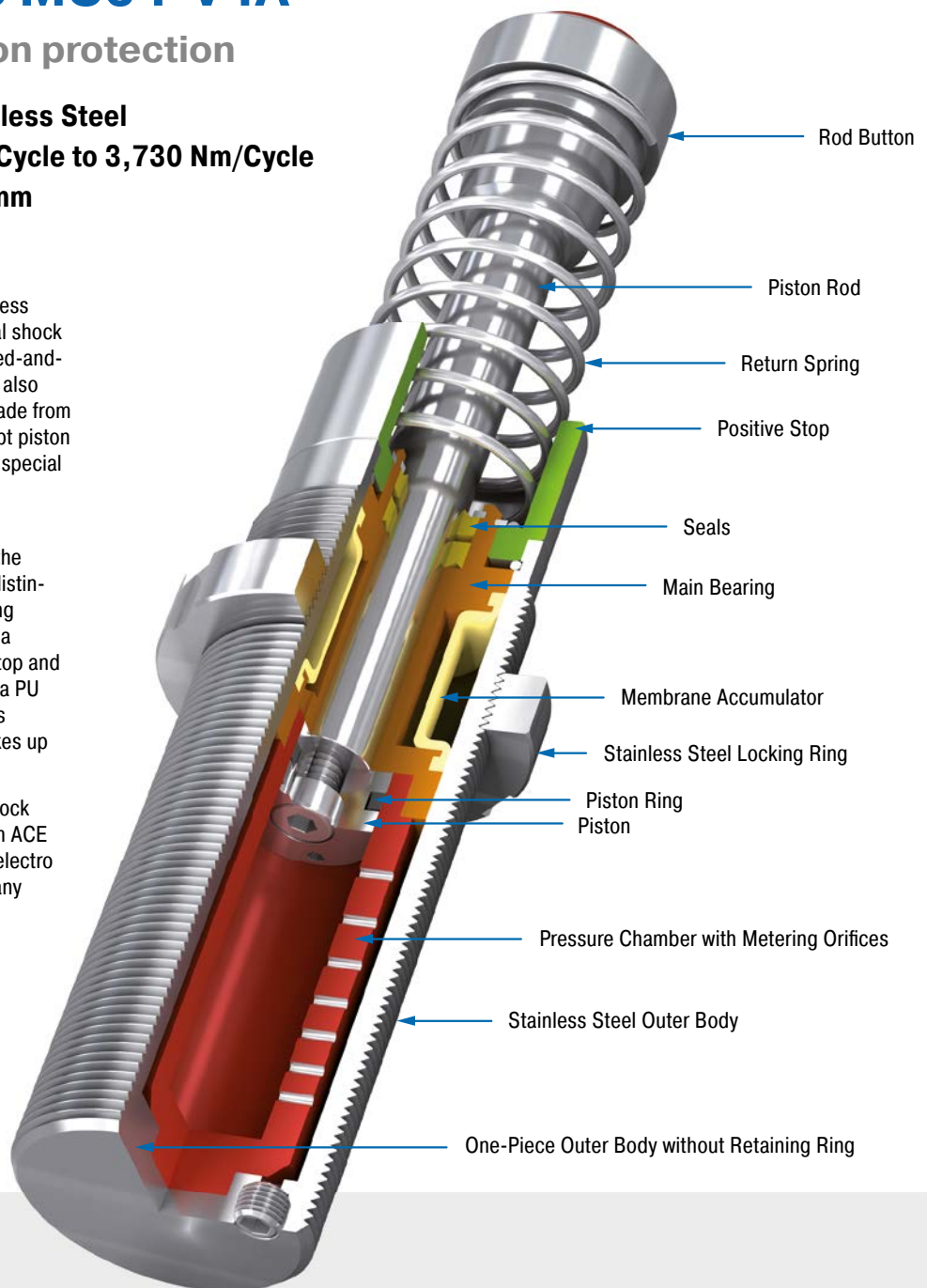

### Technical Data

**Energy capacity:** 170 Nm/Cycle to 3,730 Nm/Cycle

**Impact velocity range:** 0.15 m/s to 5 m/s. Other speeds on request.

**Operating temperature range:** -12 °C to +66 °C. Other temperatures on request.

**Mounting:** In any position

**Positive stop:** Integrated

**Material:** Outer body, Main bearing, Accessories, Locking ring: Stainless steel (1.4404, AISI 316L); Piston rod: Hard chrome plated steel; Rod end button: Stainless steel (1.4404, AISI 316L) with elastomer insert; Return spring: Stainless steel

**Damping medium:** Special oil NSF-H1 approved

**Application field:** Linear slides, Swivel units, Turntables, Food industry, Medical technology, Portal systems, Machines and plants, Tool machines, Machining centres

**Note:** Impact button (PP) for noise reduction included. For emergency use only applications and for continuous use (with additional cooling) it is sometimes possible to exceed the published max. capacity ratings. In this case, please consult ACE.

**Safety instructions:** External materials in the surrounding area can attack the seal components and lead to a shorter service life. Please

contact ACE for appropriate solution suggestions. Do not paint the shock absorbers due to heat emission.

**On request:** Special oils, other special options and special accessories are available on request.

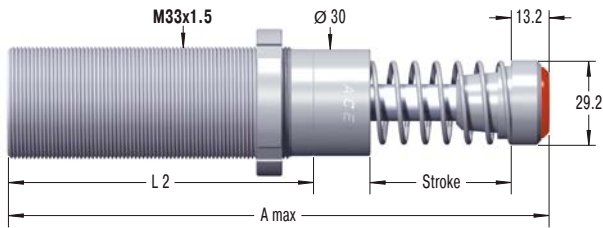
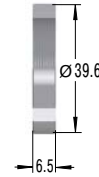
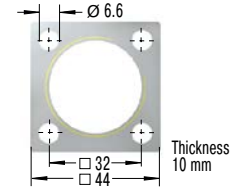
**MC33EUM-V4A**

**NM33-V4A**  
Locking Ring

**QF33-V4A**  
Square Flange

The calculation and selection of the most suitable damper should be carried out or be approved by ACE.

**Model Type Prefix**
**Standard Models**

MC: Self-Contained with return spring, self-compensating

**Special Models**

MCA: Air/Oil return without return spring.

Use only with external air/oil tank.

MCS: Air/Oil return with return spring.

Use only with external air/oil tank.

MCN: Self-Contained without return spring

**Ordering Example**
**MC3325EUM-2-V4A**

Self-Compensating \_\_\_\_\_  
 Thread Size M33 \_\_\_\_\_  
 Stroke 25 mm \_\_\_\_\_  
 EU Compliant \_\_\_\_\_  
 Metric Thread \_\_\_\_\_  
 Effective Weight Range Version \_\_\_\_\_  
 Stainless Steel 1.4404/AISI 316L \_\_\_\_\_

**Performance and Dimensions**

| TYPES           | Max. Energy Capacity    |                     | Effective Weight        |                         |          | Stroke mm | A max. mm | L2 mm | Return Force |        | Return Time s | Side Load    |      | Weight kg |
|-----------------|-------------------------|---------------------|-------------------------|-------------------------|----------|-----------|-----------|-------|--------------|--------|---------------|--------------|------|-----------|
|                 | W <sub>3</sub> Nm/cycle | W <sub>4</sub> Nm/h | <sup>1</sup> me min. kg | <sup>1</sup> me max. kg | Hardness |           |           |       | min. N       | max. N |               | Angle max. ° | kg   |           |
| MC3325EUM-0-V4A | 170                     | 75,000              | 3                       | 11                      | -0       | 23.2      | 151.2     | 83    | 45           | 90     | 0.03          | 4            | 0.51 |           |
| MC3325EUM-1-V4A | 170                     | 75,000              | 9                       | 40                      | -1       | 23.2      | 151.2     | 83    | 45           | 90     | 0.03          | 4            | 0.51 |           |
| MC3325EUM-2-V4A | 170                     | 75,000              | 30                      | 120                     | -2       | 23.2      | 151.2     | 83    | 45           | 90     | 0.03          | 4            | 0.51 |           |
| MC3325EUM-3-V4A | 170                     | 75,000              | 100                     | 420                     | -3       | 23.2      | 151.2     | 83    | 45           | 90     | 0.03          | 4            | 0.51 |           |
| MC3325EUM-4-V4A | 170                     | 75,000              | 350                     | 1,420                   | -4       | 23.2      | 151.2     | 83    | 45           | 90     | 0.03          | 4            | 0.51 |           |
| MC3350EUM-0-V4A | 330                     | 85,000              | 5                       | 22                      | -0       | 48.6      | 202.2     | 108   | 45           | 135    | 0.06          | 3            | 0.63 |           |
| MC3350EUM-1-V4A | 330                     | 85,000              | 18                      | 70                      | -1       | 48.6      | 202.2     | 108   | 45           | 135    | 0.06          | 3            | 0.63 |           |
| MC3350EUM-2-V4A | 330                     | 85,000              | 60                      | 250                     | -2       | 48.6      | 202.2     | 108   | 45           | 135    | 0.06          | 3            | 0.63 |           |
| MC3350EUM-3-V4A | 330                     | 85,000              | 210                     | 840                     | -3       | 48.6      | 202.2     | 108   | 45           | 135    | 0.06          | 3            | 0.63 |           |
| MC3350EUM-4-V4A | 330                     | 85,000              | 710                     | 2,830                   | -4       | 48.6      | 202.2     | 108   | 45           | 135    | 0.06          | 3            | 0.63 |           |

<sup>1</sup> For emergency use only applications it is sometimes possible to exceed the above ratings. Please consult ACE for further details.

<sup>2</sup> For applications with higher side load angles consider using the side load adaptor (BV) pages 74 to 77.

self-Compensating, stainless Steel

**MC45EUM-V4A**

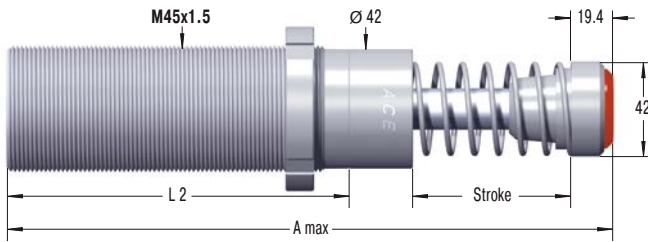

**NM45-V4A**  
Locking Ring

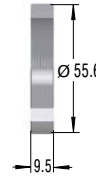

**QF45-V4A**  
Square Flange

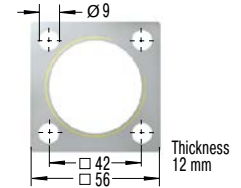

The calculation and selection of the most suitable damper should be carried out or be approved by ACE.

**Model Type Prefix**

**Standard Models**

MC: Self-Contained with return spring, self-compensating

**Special Models**

MCA: Air/Oil return without return spring.  
Use only with external air/oil tank.

MCS: Air/Oil return with return spring.  
Use only with external air/oil tank.

MCN: Self-Contained without return spring

**Ordering Example**

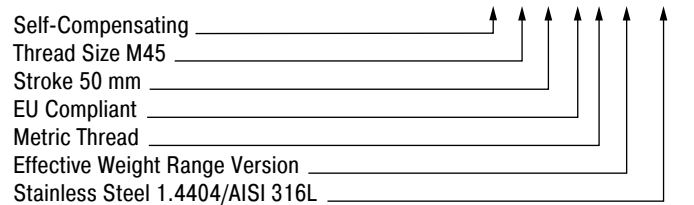

**Performance and Dimensions**

| TYPES           | Max. Energy Capacity    |                     | Effective Weight        |                         |          | Stroke mm | A max. mm | L2 mm | Return Force |        | Return Time s | Side Load    |      | Weight kg |
|-----------------|-------------------------|---------------------|-------------------------|-------------------------|----------|-----------|-----------|-------|--------------|--------|---------------|--------------|------|-----------|
|                 | W <sub>3</sub> Nm/cycle | W <sub>4</sub> Nm/h | <sup>1</sup> me min. kg | <sup>1</sup> me max. kg | Hardness |           |           |       | min. N       | max. N |               | Angle max. ° | kg   |           |
| MC4525EUM-0-V4A | 370                     | 107,000             | 7                       | 27                      | -0       | 23.1      | 164.5     | 95    | 70           | 100    | 0.03          | 4            | 1.14 |           |
| MC4525EUM-1-V4A | 370                     | 107,000             | 20                      | 90                      | -1       | 23.1      | 164.5     | 95    | 70           | 100    | 0.03          | 4            | 1.14 |           |
| MC4525EUM-2-V4A | 370                     | 107,000             | 80                      | 310                     | -2       | 23.1      | 164.5     | 95    | 70           | 100    | 0.03          | 4            | 1.14 |           |
| MC4525EUM-3-V4A | 370                     | 107,000             | 260                     | 1,050                   | -3       | 23.1      | 164.5     | 95    | 70           | 100    | 0.03          | 4            | 1.14 |           |
| MC4525EUM-4-V4A | 370                     | 107,000             | 890                     | 3,540                   | -4       | 23.1      | 164.5     | 95    | 70           | 100    | 0.03          | 4            | 1.14 |           |
| MC4550EUM-0-V4A | 740                     | 112,000             | 13                      | 54                      | -0       | 48.5      | 214.4     | 120   | 70           | 145    | 0.08          | 3            | 1.36 |           |
| MC4550EUM-1-V4A | 740                     | 112,000             | 45                      | 180                     | -1       | 48.5      | 214.4     | 120   | 70           | 145    | 0.08          | 3            | 1.36 |           |
| MC4550EUM-2-V4A | 740                     | 112,000             | 150                     | 620                     | -2       | 48.5      | 214.4     | 120   | 70           | 145    | 0.08          | 3            | 1.36 |           |
| MC4550EUM-3-V4A | 740                     | 112,000             | 520                     | 2,090                   | -3       | 48.5      | 214.4     | 120   | 70           | 145    | 0.08          | 3            | 1.36 |           |
| MC4550EUM-4-V4A | 740                     | 112,000             | 1,800                   | 7,100                   | -4       | 48.5      | 214.4     | 120   | 70           | 145    | 0.08          | 3            | 1.36 |           |
| MC4575EUM-0-V4A | 1,130                   | 146,000             | 20                      | 80                      | -0       | 73.9      | 265.4     | 145   | 50           | 180    | 0.11          | 2            | 1.59 |           |
| MC4575EUM-1-V4A | 1,130                   | 146,000             | 70                      | 270                     | -1       | 73.9      | 265.4     | 145   | 50           | 180    | 0.11          | 2            | 1.59 |           |
| MC4575EUM-2-V4A | 1,130                   | 146,000             | 230                     | 930                     | -2       | 73.9      | 265.4     | 145   | 50           | 180    | 0.11          | 2            | 1.59 |           |
| MC4575EUM-3-V4A | 1,130                   | 146,000             | 790                     | 3,140                   | -3       | 73.9      | 265.4     | 145   | 50           | 180    | 0.11          | 2            | 1.59 |           |
| MC4575EUM-4-V4A | 1,130                   | 146,000             | 2,650                   | 10,600                  | -4       | 73.9      | 265.4     | 145   | 50           | 180    | 0.11          | 2            | 1.59 |           |

<sup>1</sup> For emergency use only applications it is sometimes possible to exceed the above ratings. Please consult ACE for further details.

<sup>2</sup> For applications with higher side load angles consider using the side load adaptor (BV) pages 74 to 77.

### MC64EUM-V4A

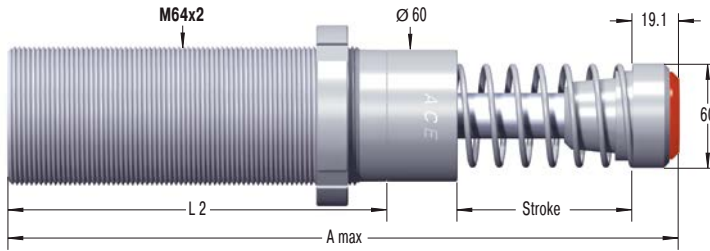

### NM64-V4A Locking Ring

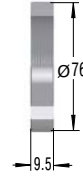

### QF64-V4A Square Flange

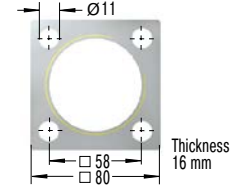

The calculation and selection of the most suitable damper should be carried out or be approved by ACE.

### Model Type Prefix

#### Standard Models

MC: Self-Contained with return spring, self-compensating

#### Special Models

MCA: Air/Oil return without return spring.

Use only with external air/oil tank.

MCS: Air/Oil return with return spring.

Use only with external air/oil tank.

MCN: Self-Contained without return spring

### Ordering Example

### MC6450EUM-3-V4A

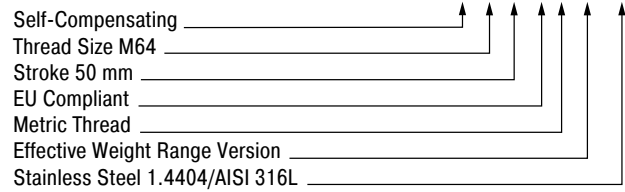

### Performance and Dimensions

| TYPES            | Max. Energy Capacity    |                     | Effective Weight        |                         |          | Stroke mm | A max. mm | L2 mm | Return Force |        | Return Time s | Side Load    |     | Weight kg |
|------------------|-------------------------|---------------------|-------------------------|-------------------------|----------|-----------|-----------|-------|--------------|--------|---------------|--------------|-----|-----------|
|                  | W <sub>3</sub> Nm/cycle | W <sub>4</sub> Nm/h | <sup>1</sup> me min. kg | <sup>1</sup> me max. kg | Hardness |           |           |       | min. N       | max. N |               | Angle max. ° |     |           |
| MC6450EUM-0-V4A  | 1,870                   | 146,000             | 35                      | 140                     | -0       | 48.6      | 244.1     | 140   | 90           | 155    | 0.12          | 4            | 2.9 |           |
| MC6450EUM-1-V4A  | 1,870                   | 146,000             | 140                     | 540                     | -1       | 48.6      | 244.1     | 140   | 90           | 155    | 0.12          | 4            | 2.9 |           |
| MC6450EUM-2-V4A  | 1,870                   | 146,000             | 460                     | 1,850                   | -2       | 48.6      | 244.1     | 140   | 90           | 155    | 0.12          | 4            | 2.9 |           |
| MC6450EUM-3-V4A  | 1,870                   | 146,000             | 1,600                   | 6,300                   | -3       | 48.6      | 244.1     | 140   | 90           | 155    | 0.12          | 4            | 2.9 |           |
| MC6450EUM-4-V4A  | 1,870                   | 146,000             | 5,300                   | 21,200                  | -4       | 48.6      | 244.1     | 140   | 90           | 155    | 0.12          | 4            | 2.9 |           |
| MC64100EUM-0-V4A | 3,730                   | 192,000             | 70                      | 280                     | -0       | 99.4      | 345.1     | 191   | 105          | 270    | 0.34          | 3            | 3.7 |           |
| MC64100EUM-1-V4A | 3,730                   | 192,000             | 270                     | 11,000                  | -1       | 99.4      | 345.1     | 191   | 105          | 270    | 0.34          | 3            | 3.7 |           |
| MC64100EUM-2-V4A | 3,730                   | 192,000             | 930                     | 3,700                   | -2       | 99.4      | 345.1     | 191   | 105          | 270    | 0.34          | 3            | 3.7 |           |
| MC64100EUM-3-V4A | 3,730                   | 192,000             | 3,150                   | 12,600                  | -3       | 99.4      | 345.1     | 191   | 105          | 270    | 0.34          | 3            | 3.7 |           |
| MC64100EUM-4-V4A | 3,730                   | 192,000             | 10,600                  | 42,500                  | -4       | 99.4      | 345.1     | 191   | 105          | 270    | 0.34          | 3            | 3.7 |           |

<sup>1</sup> For emergency use only applications it is sometimes possible to exceed the above ratings. Please consult ACE for further details.

<sup>2</sup> For applications with higher side load angles consider using the side load adaptor (BV) pages 74 to 77.

## MC33-HT to MC64-HT

Extremely heat-resistant at high cycle frequencies

**Self-Compensating, use at 0 °C to 150 °C**

**Energy capacity 170 Nm/Cycle to 3,730 Nm/Cycle**

**Stroke 23.1 mm to 99.4 mm**

Further possibilities of use: Just like all MAGNUM types from the product family MC33 to MC64, the HT (high temperature) industrial shock absorbers are also made from one solid piece. They are characterised by the use of special seals and fluids. This means that these versions can even be used at extreme temperatures of 0 °C to 150 °C in order to safely and reliably damp masses and take away 100 % kinetic energy.

There is no reason why these ready-to-install machine elements should not be used, even under the most unfavourable conditions. Additional benefits are their robust, innovative sealing technology, high energy absorption in a compact design, fixed positive stop and a wide damping range.

Designed for use in extreme temperature ranges, these self-compensating industrial shock absorbers are suitable almost anywhere in plant and mechanical engineering.

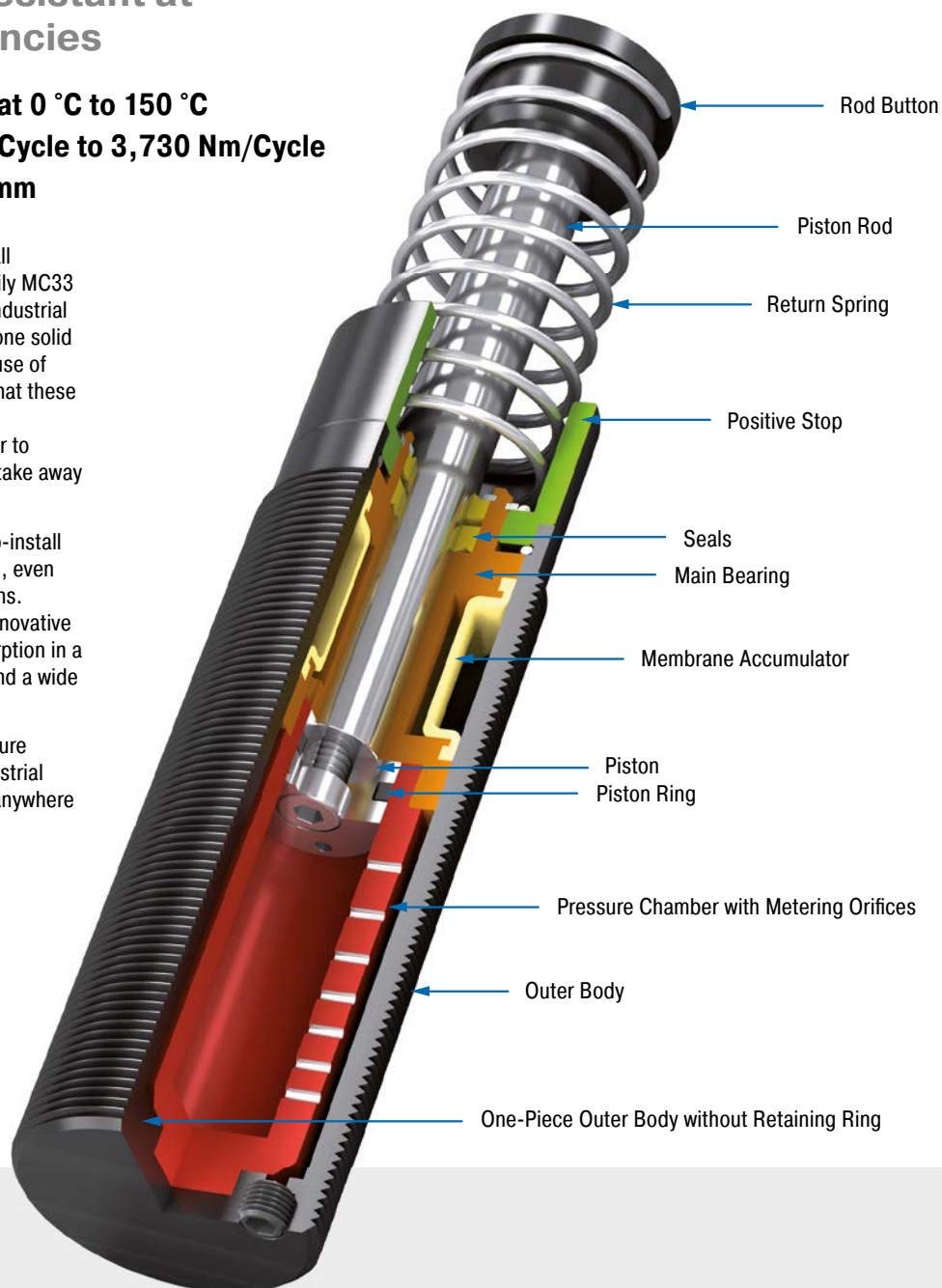

### Technical Data

**Energy capacity:** 170 Nm/Cycle to 3,730 Nm/Cycle

**Impact velocity range:** 0.15 m/s to 5 m/s.  
Other speeds on request.

**Operating temperature range:** 0 °C to 150 °C

**Mounting:** In any position

**Positive stop:** Integrated

**Material:** Outer body: Nitride hardened steel; Piston rod: Hard chrome plated steel; Rod end button: Hardened steel and corrosion-resistant coating; Return spring: Zinc plated or plastic-coated steel; Accessories: Steel with black oxide finish or nitride hardened

**Damping medium:** Synthetic high temperature oil

**Application field:** Linear slides, Swivel units, Turntables, Machines and plants, Tool machines, Machining centres, Z-axes

**Note:** A noise reduction of 3 to 7 dB is possible when using the special impact button (PP).

**Safety instructions:** External materials in the surrounding area can attack the seal components and lead to a shorter service life. Please contact ACE for appropriate solution suggestions. Do not paint the shock absorbers due to heat emission.

**On request:** Nickel-plated, increased corrosion protection, mounting inside air cylinders or other special options are available on request. Adjustable HT and LT shock absorbers.

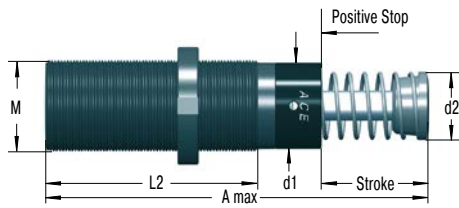
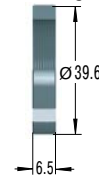
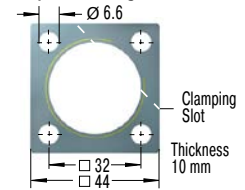

**MC33EUM-HT**

**NM33**  
Locking Ring

**QF33**  
Square Flange

Torque max.: 11 Nm  
Clamping torque: > 90 Nm  
Install with 4 machine screws

The calculation and selection of the most suitable damper should be carried out or be approved by ACE.

**Complete details required when ordering**

- Load to be decelerated: m (kg)
- Impact velocity: v (m/s)
- Propelling force: F (N)
- Operating cycles per hour: c (/hr)
- Number of absorbers in parallel: n
- Ambient temperature: °C

**Ordering Example**

Self-Compensating \_\_\_\_\_ **MC3350EUM-2-HT**

Thread Size M33 \_\_\_\_\_

Stroke 50 mm \_\_\_\_\_

EU Compliant \_\_\_\_\_

Metric Thread (omitted when using thread UNF) \_\_\_\_\_

Effective Weight Range Code \_\_\_\_\_

HT = Version for High Temperature Use \_\_\_\_\_

**Dimensions**

| TYPES        | Stroke<br>mm | A max.<br>mm | d1<br>mm | d2<br>mm | L2<br>mm | M       |
|--------------|--------------|--------------|----------|----------|----------|---------|
| MC3325EUM-HT | 23.2         | 138          | 30       | 25       | 83       | M33x1.5 |
| MC3350EUM-HT | 48.6         | 189          | 30       | 25       | 108      | M33x1.5 |

**Performance**

| TYPES          | Max. Energy Capacity       |                                 |                                  | Effective Weight           |                            |          | Side Load Angle max.<br>° | Weight<br>kg |
|----------------|----------------------------|---------------------------------|----------------------------------|----------------------------|----------------------------|----------|---------------------------|--------------|
|                | W <sub>3</sub><br>Nm/cycle | W <sub>4</sub> at 20 °C<br>Nm/h | W <sub>4</sub> at 100 °C<br>Nm/h | <sup>1</sup> me min.<br>kg | <sup>1</sup> me max.<br>kg | Hardness |                           |              |
| MC3325EUM-0-HT | 170                        | 215,000                         | 82,000                           | 3                          | 11                         | -0       | 4                         | 0.51         |
| MC3325EUM-1-HT | 170                        | 215,000                         | 82,000                           | 9                          | 40                         | -1       | 4                         | 0.51         |
| MC3325EUM-2-HT | 170                        | 215,000                         | 82,000                           | 30                         | 120                        | -2       | 4                         | 0.51         |
| MC3325EUM-3-HT | 170                        | 215,000                         | 82,000                           | 100                        | 420                        | -3       | 4                         | 0.51         |
| MC3325EUM-4-HT | 170                        | 215,000                         | 82,000                           | 350                        | 1,420                      | -4       | 4                         | 0.51         |
| MC3350EUM-0-HT | 330                        | 244,000                         | 93,000                           | 5                          | 22                         | -0       | 3                         | 0.63         |
| MC3350EUM-1-HT | 330                        | 244,000                         | 93,000                           | 18                         | 70                         | -1       | 3                         | 0.63         |
| MC3350EUM-2-HT | 330                        | 244,000                         | 93,000                           | 60                         | 250                        | -2       | 3                         | 0.63         |
| MC3350EUM-3-HT | 330                        | 244,000                         | 93,000                           | 240                        | 840                        | -3       | 3                         | 0.63         |
| MC3350EUM-4-HT | 330                        | 244,000                         | 93,000                           | 710                        | 2,830                      | -4       | 3                         | 0.63         |

<sup>1</sup> The effective weight range limits can be raised or lowered to special order.

<sup>2</sup> For applications with higher side load angles consider using the side load adaptor (BV) pages 74 to 77.



Self-Compensating

**MC45EUM-HT**

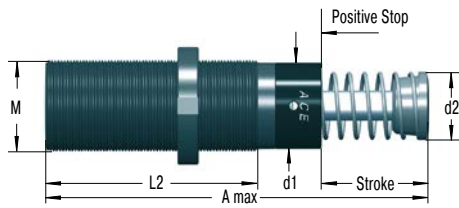

**NM45**  
Locking Ring

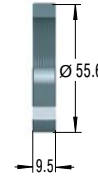

**QF45**  
Square Flange

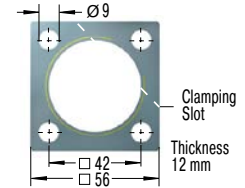

Torque max.: 27 Nm  
Clamping torque: > 200 Nm  
Install with 4 machine screws

The calculation and selection of the most suitable damper should be carried out or be approved by ACE.

**Complete details required when ordering**

- Load to be decelerated: m (kg)
- Impact velocity: v (m/s)
- Propelling force: F (N)
- Operating cycles per hour: c (/hr)
- Number of absorbers in parallel: n
- Ambient temperature: °C

**Ordering Example**

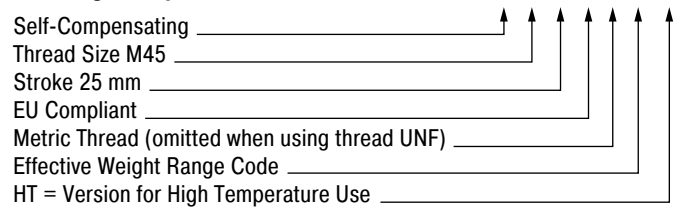

**Dimensions**

| TYPES        | Stroke<br>mm | A max.<br>mm | d1<br>mm | d2<br>mm | L2<br>mm | M       |
|--------------|--------------|--------------|----------|----------|----------|---------|
| MC4525EUM-HT | 23.1         | 145          | 42       | 35       | 95       | M45x1.5 |
| MC4550EUM-HT | 48.5         | 195          | 42       | 35       | 120      | M45x1.5 |

**Performance**

| TYPES          | Max. Energy Capacity       |                                 |                                  | Effective Weight           |                            |                                   | Hardness | Side Load Angle max.<br>° | Weight<br>kg |
|----------------|----------------------------|---------------------------------|----------------------------------|----------------------------|----------------------------|-----------------------------------|----------|---------------------------|--------------|
|                | W <sub>3</sub><br>Nm/cycle | W <sub>4</sub> at 20 °C<br>Nm/h | W <sub>4</sub> at 100 °C<br>Nm/h | <sup>1</sup> me min.<br>kg | <sup>1</sup> me max.<br>kg | <sup>2</sup> Side Load Angle max. |          |                           |              |
| MC4525EUM-0-HT | 370                        | 307,000                         | 117,000                          | 7                          | 27                         | -0                                | 4        | 1.14                      |              |
| MC4525EUM-1-HT | 370                        | 307,000                         | 117,000                          | 20                         | 90                         | -1                                | 4        | 1.14                      |              |
| MC4525EUM-2-HT | 370                        | 307,000                         | 117,000                          | 80                         | 310                        | -2                                | 4        | 1.14                      |              |
| MC4525EUM-3-HT | 370                        | 307,000                         | 117,000                          | 260                        | 1,050                      | -3                                | 4        | 1.14                      |              |
| MC4525EUM-4-HT | 370                        | 307,000                         | 117,000                          | 890                        | 3,540                      | -4                                | 4        | 1.14                      |              |
| MC4550EUM-0-HT | 740                        | 321,000                         | 122,000                          | 13                         | 54                         | -0                                | 3        | 1.36                      |              |
| MC4550EUM-1-HT | 740                        | 321,000                         | 122,000                          | 45                         | 180                        | -1                                | 3        | 1.36                      |              |
| MC4550EUM-2-HT | 740                        | 321,000                         | 122,000                          | 150                        | 620                        | -2                                | 3        | 1.36                      |              |
| MC4550EUM-3-HT | 740                        | 321,000                         | 122,000                          | 520                        | 2,090                      | -3                                | 3        | 1.36                      |              |
| MC4550EUM-4-HT | 740                        | 321,000                         | 122,000                          | 1,800                      | 7,100                      | -4                                | 3        | 1.36                      |              |

<sup>1</sup> The effective weight range limits can be raised or lowered to special order.  
<sup>2</sup> For applications with higher side load angles consider using the side load adaptor (BV) pages 74 to 77.

### MC64EUM-HT

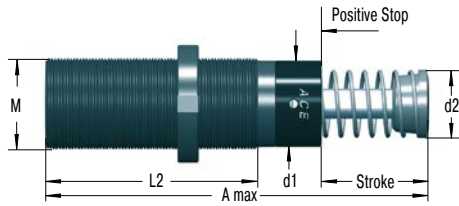

### NM64 Locking Ring

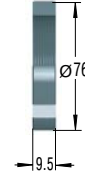

### QF64 Square Flange

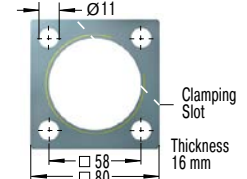

Torque max.: 50 Nm  
Clamping torque: > 210 Nm  
Install with 4 machine screws

The calculation and selection of the most suitable damper should be carried out or be approved by ACE.

### Complete details required when ordering

- Load to be decelerated: m (kg)
- Impact velocity: v (m/s)
- Propelling force: F (N)
- Operating cycles per hour: c (/hr)
- Number of absorbers in parallel: n
- Ambient temperature: °C

### Ordering Example

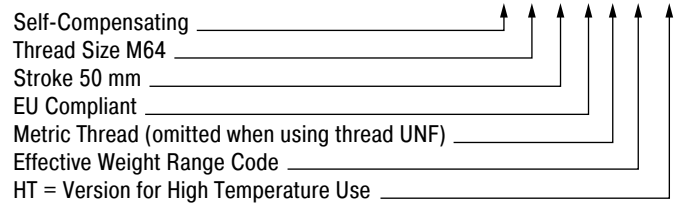

| Dimensions    |              |              |          |          |          |       |  |
|---------------|--------------|--------------|----------|----------|----------|-------|--|
| TYPES         | Stroke<br>mm | A max.<br>mm | d1<br>mm | d2<br>mm | L2<br>mm | M     |  |
| MC6450EUM-HT  | 48.6         | 225          | 60       | 48       | 140      | M64x2 |  |
| MC64100EUM-HT | 99.4         | 326          | 60       | 48       | 191      | M64x2 |  |

| Performance     |                            |                                 |                                  |                            |                            |    |          |                           |              |
|-----------------|----------------------------|---------------------------------|----------------------------------|----------------------------|----------------------------|----|----------|---------------------------|--------------|
| TYPES           | Max. Energy Capacity       |                                 |                                  | Effective Weight           |                            |    | Hardness | Side Load Angle max.<br>° | Weight<br>kg |
|                 | W <sub>3</sub><br>Nm/cycle | W <sub>4</sub> at 20 °C<br>Nm/h | W <sub>4</sub> at 100 °C<br>Nm/h | <sup>1</sup> me min.<br>kg | <sup>1</sup> me max.<br>kg |    |          |                           |              |
| MC6450EUM-0-HT  | 1,870                      | 419,000                         | 159,000                          | 35                         | 140                        | -0 | 4        | 2.9                       |              |
| MC6450EUM-1-HT  | 1,870                      | 419,000                         | 159,000                          | 140                        | 540                        | -1 | 4        | 2.9                       |              |
| MC6450EUM-2-HT  | 1,870                      | 419,000                         | 159,000                          | 460                        | 1,850                      | -2 | 4        | 2.9                       |              |
| MC6450EUM-3-HT  | 1,870                      | 419,000                         | 159,000                          | 1,600                      | 6,300                      | -3 | 4        | 2.9                       |              |
| MC6450EUM-4-HT  | 1,870                      | 419,000                         | 159,000                          | 5,300                      | 21,200                     | -4 | 4        | 2.9                       |              |
| MC64100EUM-0-HT | 3,730                      | 550,000                         | 200,000                          | 70                         | 280                        | -0 | 3        | 3.7                       |              |
| MC64100EUM-1-HT | 3,730                      | 550,000                         | 200,000                          | 270                        | 1,100                      | -1 | 3        | 3.7                       |              |
| MC64100EUM-2-HT | 3,730                      | 550,000                         | 200,000                          | 930                        | 3,700                      | -2 | 3        | 3.7                       |              |
| MC64100EUM-3-HT | 3,730                      | 550,000                         | 200,000                          | 3,150                      | 12,600                     | -3 | 3        | 3.7                       |              |
| MC64100EUM-4-HT | 3,730                      | 550,000                         | 200,000                          | 10,600                     | 42,500                     | -4 | 3        | 3.7                       |              |

<sup>1</sup> The effective weight range limits can be raised or lowered to special order.  
<sup>2</sup> For applications with higher side load angles consider using the side load adaptor (BV) pages 74 to 77.

Issue 07.2017 – Specifications subject to change

## MC33-LT to MC64-LT

Extremely low temperatures and high cycle frequencies

**Self-Compensating, use at -50 °C to +66 °C**

**Energy capacity 170 Nm/Cycle to 5,650 Nm/Cycle**

**Stroke 23.1 mm to 150 mm**

Further possibilities of use: Just like all MAGNUM types from the product family MC33 to MC64, the LT (low temperature) industrial shock absorbers are also made from one solid piece. They are characterised by the use of special seals and fluids. This means that these versions can even be used at extreme temperatures of -50 °C to +66 °C in order to safely and reliably damp masses and take away 100 % kinetic energy.

There is no reason why these ready-to-install machine elements should not be used, even under the most unfavourable conditions. Additional benefits are their robust, innovative sealing technology, high energy absorption in a compact design, fixed positive stop and a wide damping range.

Designed for use in extreme temperature ranges, these self-compensating industrial shock absorbers are suitable almost anywhere in plant and mechanical engineering.

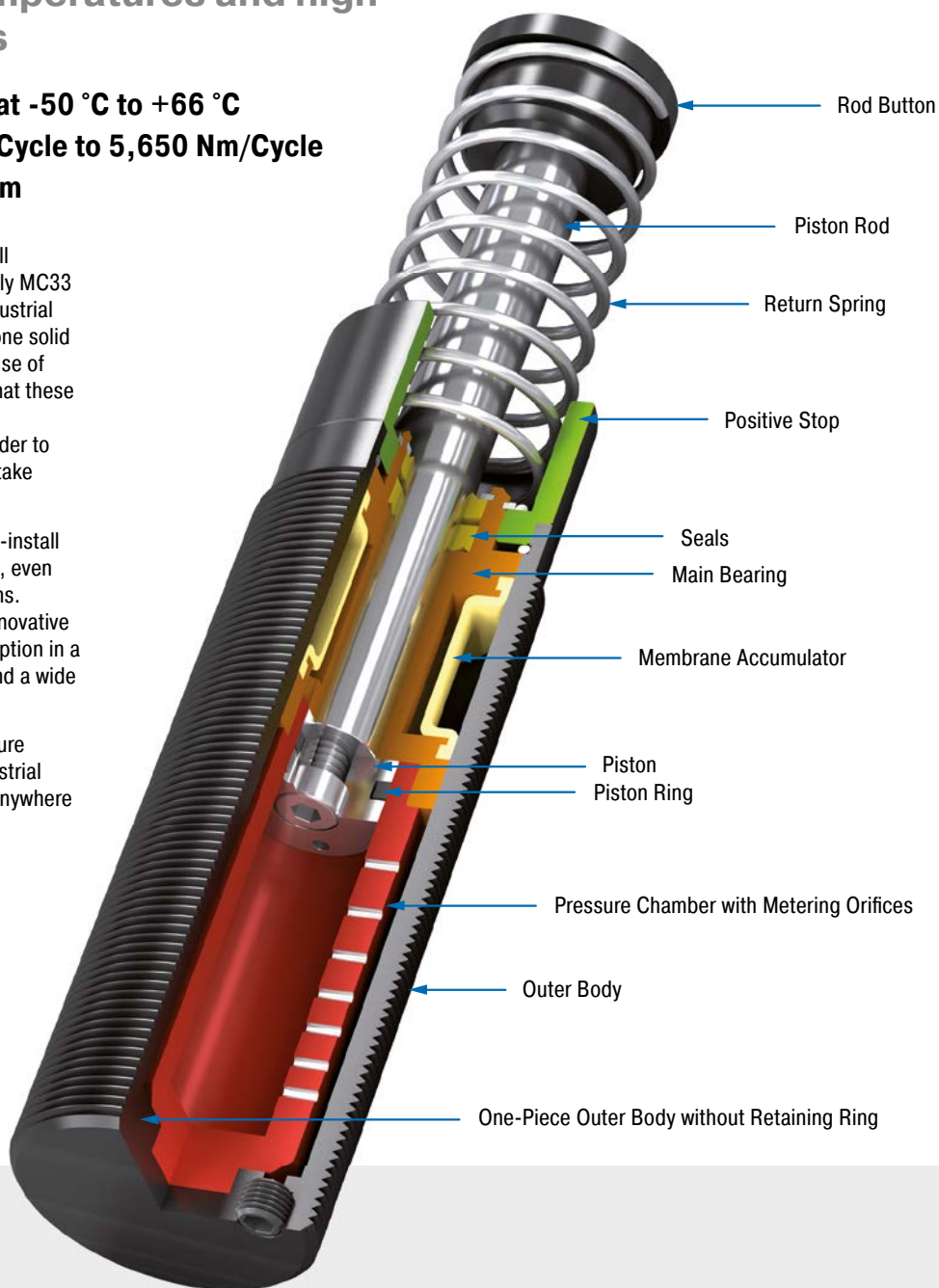

### Technical Data

**Energy capacity:** 170 Nm/Cycle to 5,650 Nm/Cycle

**Impact velocity range:** 0.15 m/s to 5 m/s.  
Other speeds on request.

**Operating temperature range:** -50 °C to +66 °C

**Mounting:** In any position

**Positive stop:** Integrated

**Material:** Outer body: Nitride hardened steel; Piston rod: Hard chrome plated steel; Rod end button: Hardened steel and corrosion-resistant coating; Return spring: Zinc plated or plastic-coated steel; Accessories: Steel with black oxide finish or nitride hardened

**Damping medium:** Low temperature hydraulic oil

**Application field:** Linear slides, Swivel units, Turntables, Machines and plants, Tool machines, Machining centres, Z-axes

**Note:** A noise reduction of 3 to 7 dB is possible when using the special impact button (PP).

**Safety instructions:** External materials in the surrounding area can attack the seal components and lead to a shorter service life. Please contact ACE for appropriate solution suggestions. Do not paint the shock absorbers due to heat emission.

**On request:** Nickel-plated, increased corrosion protection, mounting inside air cylinders or other special options are available on request. Adjustable HT and LT shock absorbers.

### MC33EUM-LT

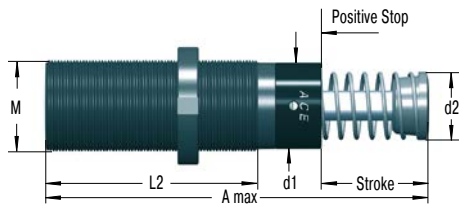

### NM33 Locking Ring

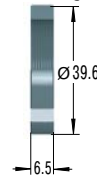

### QF33 Square Flange

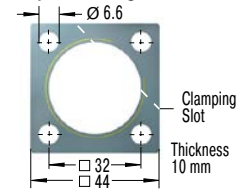

Torque max.: 11 Nm  
Clamping torque: > 90 Nm  
Install with 4 machine screws

The calculation and selection of the most suitable damper should be carried out or be approved by ACE.

### Complete details required when ordering

- Load to be decelerated: m (kg)
- Impact velocity: v (m/s)
- Propelling force: F (N)
- Operating cycles per hour: c (/hr)
- Number of absorbers in parallel: n
- Ambient temperature: °C

### Ordering Example

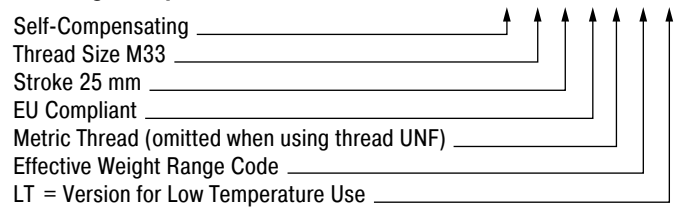

### Dimensions

| TYPES        | Stroke<br>mm | A max.<br>mm | d1<br>mm | d2<br>mm | L2<br>mm | M       |
|--------------|--------------|--------------|----------|----------|----------|---------|
| MC3325EUM-LT | 23.2         | 138          | 30       | 25       | 83       | M33x1.5 |
| MC3350EUM-LT | 48.6         | 189          | 30       | 25       | 108      | M33x1.5 |

### Performance

| TYPES          | Max. Energy Capacity       |                        | Effective Weight           |                            |          | Return Time<br>s | Side Load Angle<br>max.<br>° | Weight<br>kg |
|----------------|----------------------------|------------------------|----------------------------|----------------------------|----------|------------------|------------------------------|--------------|
|                | W <sub>2</sub><br>Nm/cycle | W <sub>4</sub><br>Nm/h | <sup>1</sup> me min.<br>kg | <sup>1</sup> me max.<br>kg | Hardness |                  |                              |              |
| MC3325EUM-0-LT | 170                        | 75,000                 | 3                          | 11                         | -0       | 0.08             | 4                            | 0.51         |
| MC3325EUM-1-LT | 170                        | 75,000                 | 9                          | 40                         | -1       | 0.08             | 4                            | 0.51         |
| MC3325EUM-2-LT | 170                        | 75,000                 | 30                         | 120                        | -2       | 0.08             | 4                            | 0.51         |
| MC3325EUM-3-LT | 170                        | 75,000                 | 100                        | 420                        | -3       | 0.08             | 4                            | 0.51         |
| MC3325EUM-4-LT | 170                        | 75,000                 | 350                        | 1,420                      | -4       | 0.08             | 4                            | 0.51         |
| MC3350EUM-0-LT | 330                        | 85,000                 | 5                          | 22                         | -0       | 0.16             | 3                            | 0.63         |
| MC3350EUM-1-LT | 330                        | 85,000                 | 18                         | 70                         | -1       | 0.16             | 3                            | 0.63         |
| MC3350EUM-2-LT | 330                        | 85,000                 | 60                         | 250                        | -2       | 0.16             | 3                            | 0.63         |
| MC3350EUM-3-LT | 330                        | 85,000                 | 240                        | 840                        | -3       | 0.16             | 3                            | 0.63         |
| MC3350EUM-4-LT | 330                        | 85,000                 | 710                        | 2,830                      | -4       | 0.16             | 3                            | 0.63         |

<sup>1</sup> The effective weight range limits can be raised or lowered to special order.

<sup>2</sup> at -50 °C

<sup>3</sup> For applications with higher side load angles consider using the side load adaptor (BV) pages 74 to 77.

Self-Compensating

MC45EUM-LT

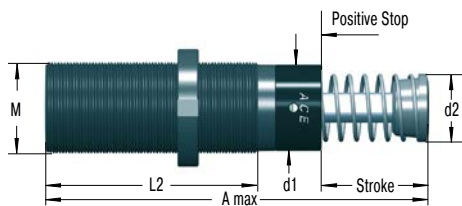

NM45 Locking Ring

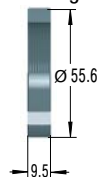

QF45 Square Flange

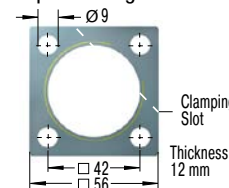

Torque max.: 27 Nm  
Clamping torque: > 200 Nm  
Install with 4 machine screws

The calculation and selection of the most suitable damper should be carried out or be approved by ACE.

Complete details required when ordering

- Load to be decelerated: m (kg)
- Impact velocity: v (m/s)
- Propelling force: F (N)
- Operating cycles per hour: c (/hr)
- Number of absorbers in parallel: n
- Ambient temperature: °C

Ordering Example

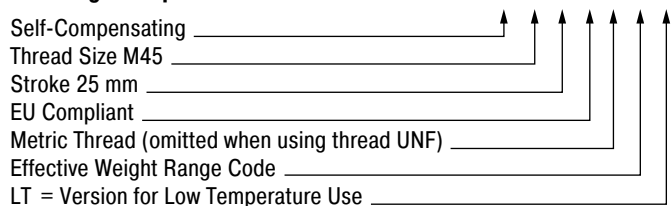

Dimensions

| TYPES        | Stroke<br>mm | A max.<br>mm | d1<br>mm | d2<br>mm | L2<br>mm | M       |
|--------------|--------------|--------------|----------|----------|----------|---------|
| MC4525EUM-LT | 23.1         | 145          | 42       | 35       | 95       | M45x1.5 |
| MC4550EUM-LT | 48.5         | 195          | 42       | 35       | 120      | M45x1.5 |
| MC4575EUM-LT | 73.9         | 246          | 42       | 35       | 145      | M45x1.5 |

Performance

| TYPES          | Max. Energy Capacity       |                        | Effective Weight           |                            |          | Return Time<br>s | Side Load Angle<br>max.<br>° | Weight<br>kg |
|----------------|----------------------------|------------------------|----------------------------|----------------------------|----------|------------------|------------------------------|--------------|
|                | W <sub>0</sub><br>Nm/cycle | W <sub>4</sub><br>Nm/h | <sup>1</sup> me min.<br>kg | <sup>1</sup> me max.<br>kg | Hardness |                  |                              |              |
| MC4525EUM-0-LT | 370                        | 107,000                | 7                          | 27                         | -0       | 0.08             | 4                            | 1.14         |
| MC4525EUM-1-LT | 370                        | 107,000                | 20                         | 90                         | -1       | 0.08             | 4                            | 1.14         |
| MC4525EUM-2-LT | 370                        | 107,000                | 80                         | 310                        | -2       | 0.08             | 4                            | 1.14         |
| MC4525EUM-3-LT | 370                        | 107,000                | 260                        | 1,050                      | -3       | 0.08             | 4                            | 1.14         |
| MC4525EUM-4-LT | 370                        | 107,000                | 890                        | 3,540                      | -4       | 0.08             | 4                            | 1.14         |
| MC4550EUM-0-LT | 740                        | 112,000                | 13                         | 54                         | -0       | 0.16             | 3                            | 1.36         |
| MC4550EUM-1-LT | 740                        | 112,000                | 45                         | 180                        | -1       | 0.16             | 3                            | 1.36         |
| MC4550EUM-2-LT | 740                        | 112,000                | 150                        | 620                        | -2       | 0.16             | 3                            | 1.36         |
| MC4550EUM-3-LT | 740                        | 112,000                | 520                        | 2,090                      | -3       | 0.16             | 3                            | 1.36         |
| MC4550EUM-4-LT | 740                        | 112,000                | 1,800                      | 7,100                      | -4       | 0.16             | 3                            | 1.36         |
| MC4575EUM-0-LT | 1,130                      | 146,000                | 20                         | 80                         | -0       | 0.24             | 2                            | 1.59         |
| MC4575EUM-1-LT | 1,130                      | 146,000                | 20                         | 80                         | -1       | 0.24             | 2                            | 1.59         |
| MC4575EUM-2-LT | 1,130                      | 146,000                | 70                         | 270                        | -2       | 0.24             | 2                            | 1.59         |
| MC4575EUM-3-LT | 1,130                      | 146,000                | 230                        | 930                        | -3       | 0.24             | 2                            | 1.59         |
| MC4575EUM-4-LT | 1,130                      | 146,000                | 2,650                      | 10,600                     | -4       | 0.24             | 2                            | 1.59         |

<sup>1</sup> The effective weight range limits can be raised or lowered to special order.  
<sup>2</sup> at -50 °C  
<sup>3</sup> For applications with higher side load angles consider using the side load adaptor (BV) pages 74 to 77.

### MC64EUM-LT

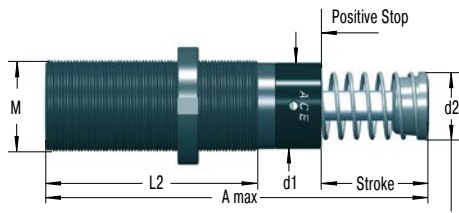

150 mm stroke model does not include stop collar.  
Positive stop is provided by the rod button (Ø 60 mm) and a stop block.

### NM64 Locking Ring

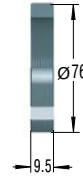

### QF64 Square Flange

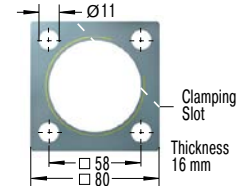

Torque max.: 50 Nm  
Clamping torque: > 210 Nm  
Install with 4 machine screws

The calculation and selection of the most suitable damper should be carried out or be approved by ACE.

### Complete details required when ordering

- Load to be decelerated: m (kg)
- Impact velocity: v (m/s)
- Propelling force: F (N)
- Operating cycles per hour: c (/hr)
- Number of absorbers in parallel: n
- Ambient temperature: °C

### Ordering Example

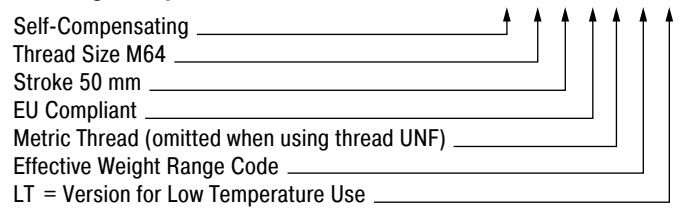

| Dimensions    |              |              |          |          |          |       |  |
|---------------|--------------|--------------|----------|----------|----------|-------|--|
| TYPES         | Stroke<br>mm | A max.<br>mm | d1<br>mm | d2<br>mm | L2<br>mm | M     |  |
| MC6450EUM-LT  | 48.6         | 225          | 60       | 48       | 140      | M64x2 |  |
| MC64100EUM-LT | 99.4         | 326          | 60       | 48       | 191      | M64x2 |  |
| MC64150EUM-LT | 150          | 450          | 60       | 48       | 241      | M64x2 |  |

| Performance     |                            |                        |                            |                            |          |                  |                           |              |
|-----------------|----------------------------|------------------------|----------------------------|----------------------------|----------|------------------|---------------------------|--------------|
| TYPES           | Max. Energy Capacity       |                        | Effective Weight           |                            |          | Return Time<br>s | Side Load Angle<br>max. ° | Weight<br>kg |
|                 | W <sub>3</sub><br>Nm/cycle | W <sub>4</sub><br>Nm/h | <sup>1</sup> me min.<br>kg | <sup>1</sup> me max.<br>kg | Hardness |                  |                           |              |
| MC6450EUM-0-LT  | 1,870                      | 146,000                | 35                         | 140                        | -0       | 0.24             | 4                         | 2.9          |
| MC6450EUM-1-LT  | 1,870                      | 146,000                | 140                        | 540                        | -1       | 0.24             | 4                         | 2.9          |
| MC6450EUM-2-LT  | 1,870                      | 146,000                | 460                        | 1,850                      | -2       | 0.24             | 4                         | 2.9          |
| MC6450EUM-3-LT  | 1,870                      | 146,000                | 1,600                      | 6,300                      | -3       | 0.24             | 4                         | 2.9          |
| MC6450EUM-4-LT  | 1,870                      | 146,000                | 5,300                      | 21,200                     | -4       | 0.24             | 4                         | 2.9          |
| MC64100EUM-0-LT | 3,730                      | 192,000                | 70                         | 280                        | -0       | 0.68             | 3                         | 3.7          |
| MC64100EUM-1-LT | 3,730                      | 192,000                | 270                        | 1,100                      | -1       | 0.68             | 3                         | 3.7          |
| MC64100EUM-2-LT | 3,730                      | 192,000                | 930                        | 3,700                      | -2       | 0.68             | 3                         | 3.7          |
| MC64100EUM-3-LT | 3,730                      | 192,000                | 3,150                      | 12,600                     | -3       | 0.68             | 3                         | 3.7          |
| MC64100EUM-4-LT | 3,730                      | 192,000                | 10,600                     | 42,500                     | -4       | 0.68             | 3                         | 3.7          |
| MC64150EUM-0-LT | 5,650                      | 248,000                | 100                        | 460                        | -0       | 0.96             | 2                         | 5.1          |
| MC64150EUM-1-LT | 5,650                      | 248,000                | 410                        | 1,640                      | -1       | 0.96             | 2                         | 5.1          |
| MC64150EUM-2-LT | 5,650                      | 248,000                | 1,390                      | 5,600                      | -2       | 0.96             | 2                         | 5.1          |
| MC64150EUM-3-LT | 5,650                      | 248,000                | 4,700                      | 18,800                     | -3       | 0.96             | 2                         | 5.1          |
| MC64150EUM-4-LT | 5,650                      | 248,000                | 16,000                     | 63,700                     | -4       | 0.96             | 2                         | 5.1          |

<sup>1</sup> The effective weight range limits can be raised or lowered to special order.  
<sup>2</sup> at -50 °C  
<sup>3</sup> For applications with higher side load angles consider using the side load adaptor (BV) pages 74 to 77.

Issue 07.2017 – Specifications subject to change



## SC33 to SC45

### Piston tube design for maximum energy absorption

#### Self-Compensating, Piston Tube Technology

Energy capacity 155 Nm/Cycle to 680 Nm/Cycle

Stroke 23.1 mm to 48.6 mm

**True performers:** The combination of the proven sealing technology from the MAGNUM range including membrane accumulator with the well-known piston tube technology from the SC<sup>2</sup> family makes the SC33 to 45 absorber models so strong and durable. The increase of the oil volume ensures the maximum effective weights. Short stroke lengths of 25 mm to 50 mm lead to shorter braking times in combination with a high energy absorption.

These dampers safely and reliably decelerate rotary movements without unwanted recoil effects. Assembly close to the pivot point is possible. The low impact speeds with this are managed with ease by ACE's generation of piston tubes.

These self-compensating industrial shock absorbers can be relied on in mechanical engineering. They are used in pivot units, rotary tables, robot arms or integrated elsewhere in construction designs.

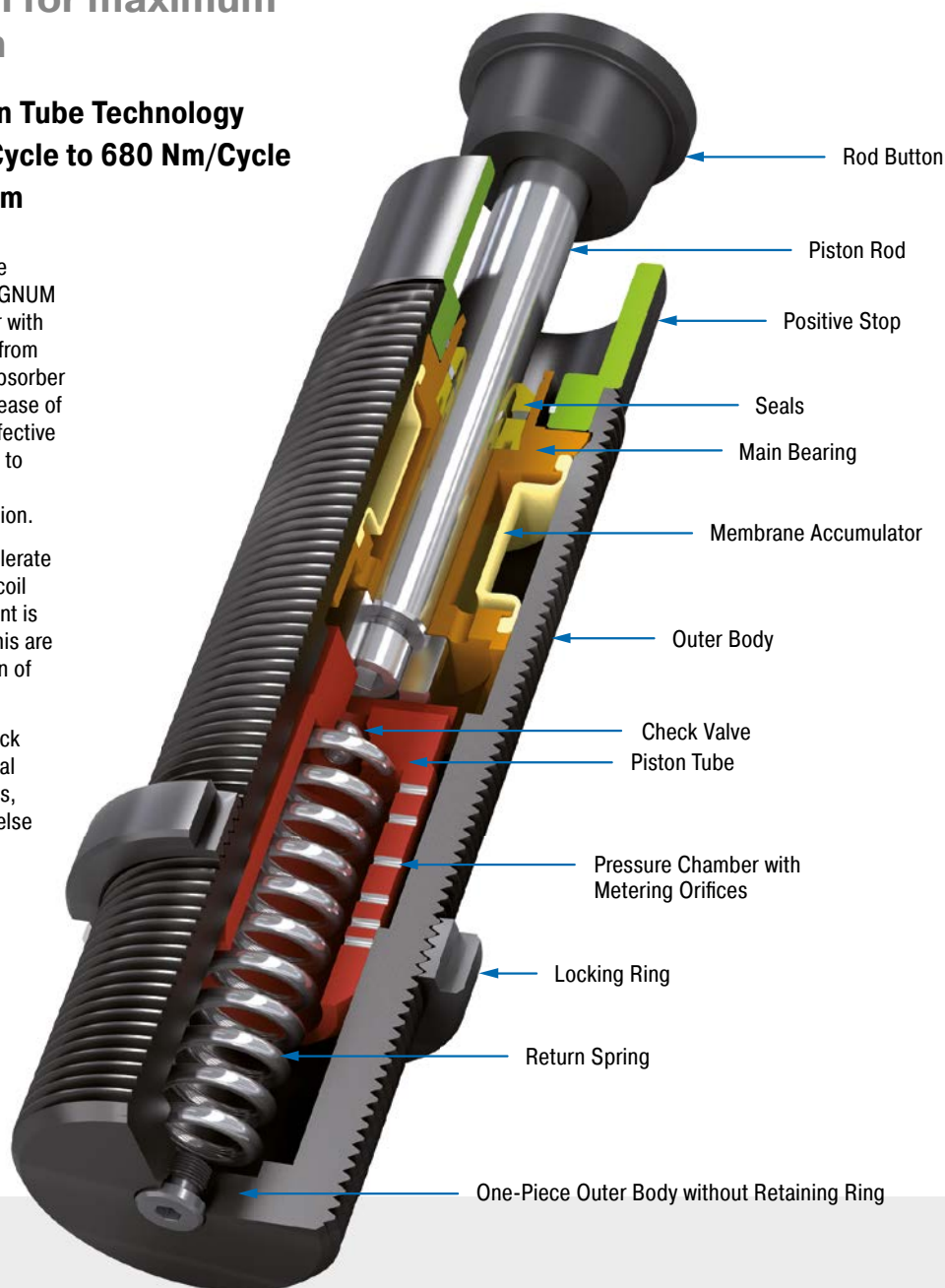

#### Technical Data

**Energy capacity:** 155 Nm/Cycle to 680 Nm/Cycle

**Impact velocity range:** 0.02 m/s to 0.46 m/s. Other speeds on request.

**Operating temperature range:** -12 °C to +66 °C. Other temperatures on request.

**Mounting:** In any position

**Positive stop:** In any position

**Material:** Outer body: Nitride hardened steel; Piston rod: Hard chrome plated steel; Rod end button: Hardened steel and corrosion-resistant coating; Accessories: Steel with black oxide finish or nitride hardened

**Damping medium:** Low temperature hydraulic oil

**Application field:** Turntables, Swivel units, Robot arms, Linear slides, Pneumatic cylinders, Handling modules, Machines and plants, Finishing and processing centres

**Note:** A noise reduction of 3 to 7 dB is possible when using the special impact button (PP).

**Safety instructions:** External materials in the surrounding area can attack the seal components and lead to a shorter service life. Please contact ACE for appropriate solution suggestions. Do not paint the shock absorbers due to heat emission.

**On request:** Special oils, mounting inside air cylinders or other special options are available on request.

### SC33EUM

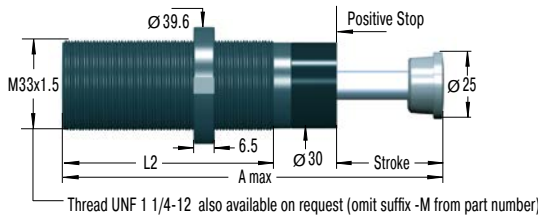

### NM33 Locking Ring

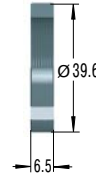

### QF33 Square Flange

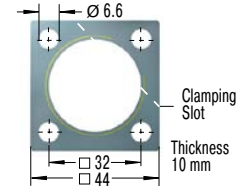

Torque max.: 11 Nm  
Clamping torque: > 90 Nm  
Install with 4 machine screws

### SC45EUM

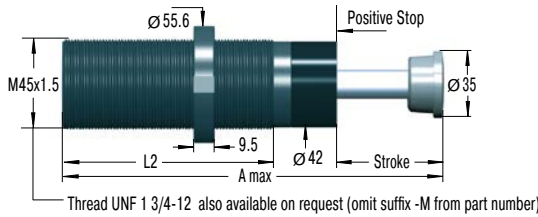

### NM45 Locking Ring

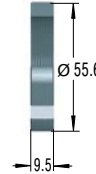

### QF45 Square Flange

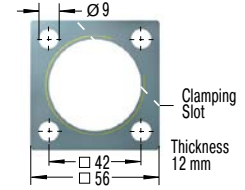

Torque max.: 27 Nm  
Clamping torque: > 200 Nm  
Install with 4 machine screws

The calculation and selection of the most suitable damper should be carried out or be approved by ACE.

### Ordering Example

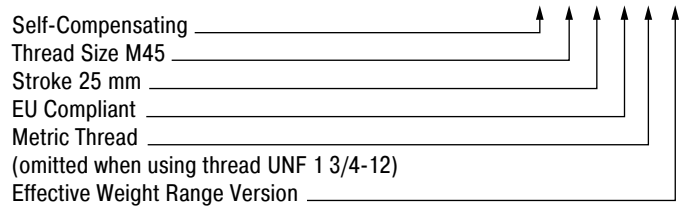

| Dimensions |              |              |          |  |
|------------|--------------|--------------|----------|--|
| TYPES      | Stroke<br>mm | A max.<br>mm | L2<br>mm |  |
| SC3325EUM  | 23.2         | 178          | 122      |  |
| SC3350EUM  | 48.6         | 254          | 173      |  |
| SC4525EUM  | 23.1         | 189          | 139      |  |
| SC4550EUM  | 48.5         | 265          | 190      |  |

| Performance |                            |                        |                            |                            |          |                           |                           |                  |                              |              |
|-------------|----------------------------|------------------------|----------------------------|----------------------------|----------|---------------------------|---------------------------|------------------|------------------------------|--------------|
| TYPES       | Max. Energy Capacity       |                        | Effective Weight           |                            |          | Return Force<br>min.<br>N | Return Force<br>max.<br>N | Return Time<br>s | Side Load Angle<br>max.<br>° | Weight<br>kg |
|             | W <sub>3</sub><br>Nm/cycle | W <sub>4</sub><br>Nm/h | <sup>1</sup> me min.<br>kg | <sup>1</sup> me max.<br>kg | Hardness |                           |                           |                  |                              |              |
| SC3325EUM-5 | 155                        | 75,000                 | 1,360                      | 2,721                      | -5       | 44                        | 89                        | 0.75             | 4                            | 0.68         |
| SC3325EUM-6 | 155                        | 75,000                 | 2,500                      | 5,443                      | -6       | 44                        | 89                        | 0.75             | 4                            | 0.68         |
| SC3325EUM-7 | 155                        | 75,000                 | 4,989                      | 8,935                      | -7       | 44                        | 89                        | 0.75             | 4                            | 0.68         |
| SC3325EUM-8 | 155                        | 75,000                 | 8,618                      | 13,607                     | -8       | 44                        | 89                        | 0.75             | 4                            | 0.68         |
| SC3350EUM-5 | 310                        | 85,000                 | 2,721                      | 4,990                      | -5       | 51                        | 125                       | 0.90             | 3                            | 0.92         |
| SC3350EUM-6 | 310                        | 85,000                 | 4,536                      | 9,980                      | -6       | 51                        | 125                       | 0.90             | 3                            | 0.92         |
| SC4525EUM-5 | 340                        | 107,000                | 3,400                      | 6,800                      | -5       | 67                        | 104                       | 0.8              | 4                            | 1.43         |
| SC4525EUM-6 | 340                        | 107,000                | 6,350                      | 13,600                     | -6       | 67                        | 104                       | 0.8              | 4                            | 1.43         |
| SC4525EUM-7 | 340                        | 107,000                | 12,700                     | 22,679                     | -7       | 67                        | 104                       | 0.8              | 4                            | 1.43         |
| SC4525EUM-8 | 340                        | 107,000                | 20,411                     | 39,000                     | -8       | 67                        | 104                       | 0.8              | 4                            | 1.43         |
| SC4550EUM-5 | 680                        | 112,000                | 6,800                      | 12,246                     | -5       | 47                        | 242                       | 1.0              | 3                            | 1.90         |
| SC4550EUM-6 | 680                        | 112,000                | 11,790                     | 26,988                     | -6       | 47                        | 242                       | 1.0              | 3                            | 1.90         |
| SC4550EUM-7 | 680                        | 112,000                | 25,854                     | 44,225                     | -7       | 47                        | 242                       | 1.0              | 3                            | 1.90         |

<sup>1</sup> The effective weight range limits can be raised or lowered to special order.  
<sup>2</sup> For applications with higher side load angles consider using the side load adaptor (BV) pages 74 to 77.

Issue 07.2017 – Specifications subject to change

## MA/ML33 to MA/ML64

### High energy absorption and progressive adjustment

#### Adjustable

**Energy capacity 170 Nm/Cycle to 6,780 Nm/Cycle**  
**Stroke 23.1 mm to 150 mm**

Adjustable and unique: These industrial shock absorbers from ACE, which can be precisely adjusted both at the front and rear, also contribute towards the success of the MAGNUM series. Equipped with excellent sealing technology, an annealed guide bearing and integrated positive stop, they are robust and durable.

These dampers absorb 50 % more energy than their predecessors but are built even more compactly. The larger range of effective loads also opens up various options in design and assembly. This makes the ML series especially suitable for effective loads of 300 kg to 500,000 kg. Where work is done with changing application data and wherever flexibility is required, they make the best option.

These adjustable industrial shock absorbers are used in all areas of mechanical engineering - e.g. in automation, integrated in linear carriages or pivoting units and also for gantries.

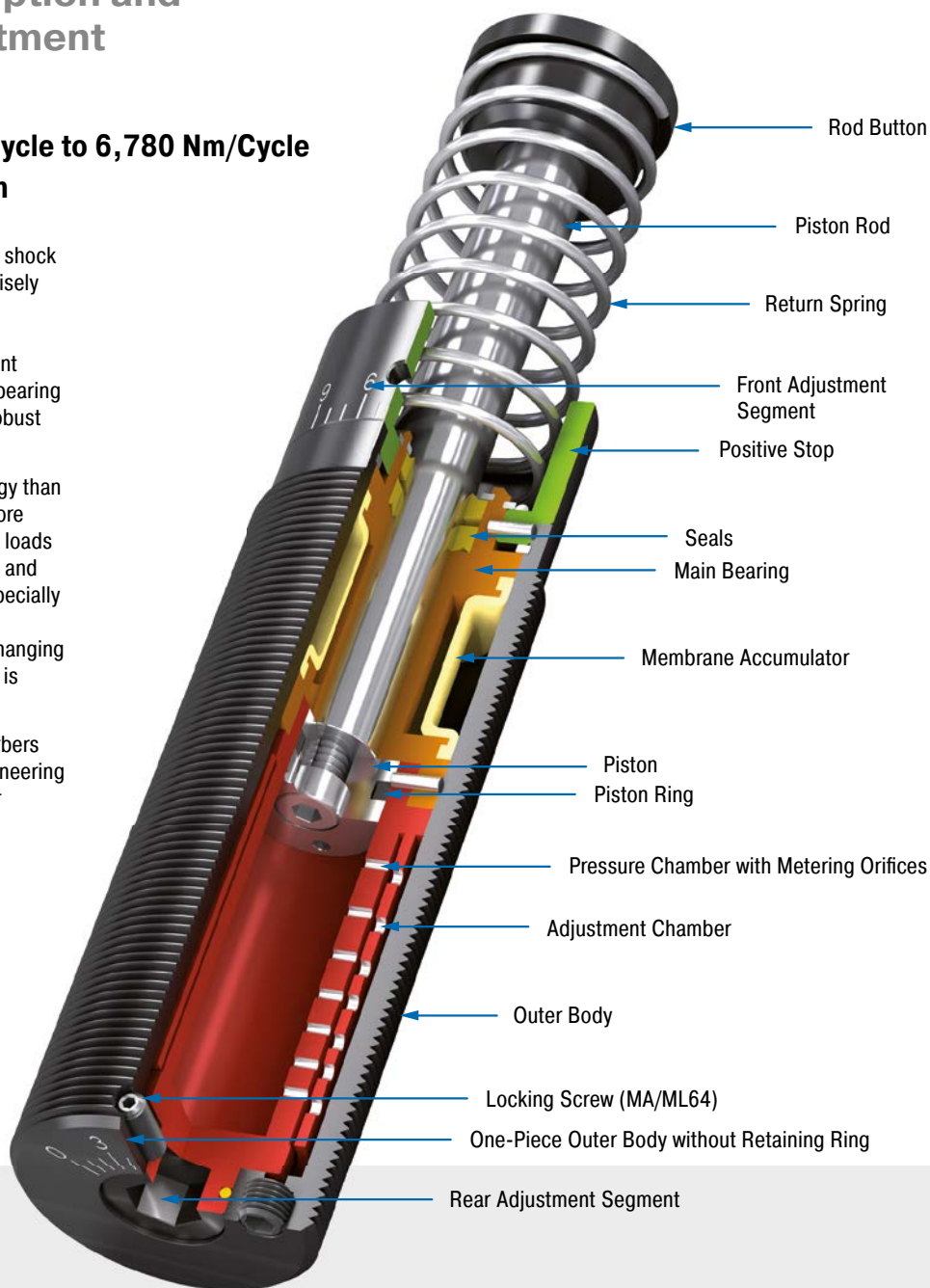

#### Technical Data

**Energy capacity:** 170 Nm/Cycle to 6,780 Nm/Cycle

**Impact velocity range:** MA: 0.15 m/s to 5 m/s. ML: 0.02 m/s to 0.46 m/s. Other speeds on request.

**Operating temperature range:** -12 °C to +66 °C

Other temperatures on request.

**Mounting:** In any position

**Positive stop:** Integrated

**Adjustment:** Hard impact at the start of stroke, adjust the ring towards 9 or PLUS. Hard impact at the end of stroke, adjust the ring towards 0 or MINUS.

**Material:** Outer body: Nitride hardened steel; Piston rod: Hard chrome plated steel; Rod end button: Hardened steel and corrosion-resistant coating; Return spring: Zinc plated or plastic-coated steel; Accessories: Steel with black oxide finish or nitride hardened

**Damping medium:** Automatic Transmission Fluid (ATF)

**Application field:** Linear slides, Swivel units, Turntables, Portal systems, Machines and plants, Tool machines, Machining centres, Z-axes, Impact panels

**Note:** A noise reduction of 3 to 7 dB is possible when using the special impact button (PP). For emergency use only applications and

for continuous use (with additional cooling) it is sometimes possible to exceed the published max. capacity ratings. In this case, please consult ACE.

**Safety instructions:** External materials in the surrounding area can attack the seal components and lead to a shorter service life. Please contact ACE for appropriate solution suggestions. Do not paint the shock absorbers due to heat emission.

**On request:** Special oils, nickel-plated, increased corrosion protection, mounting inside air cylinders or other special options are available on request.

### MA/ML33EUM

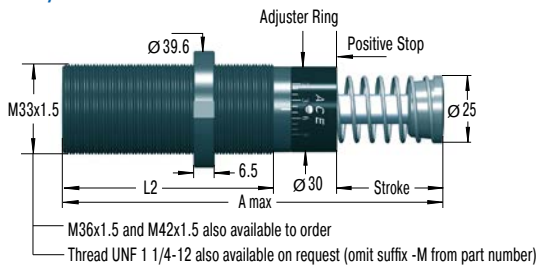

Adjuster

### NM33 Locking Ring

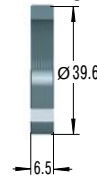

### QF33 Square Flange

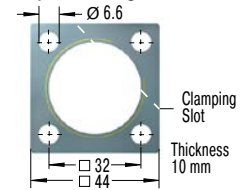

Torque max.: 11 Nm  
Clamping torque: > 90 Nm  
Install with 4 machine screws

The calculation and selection of the most suitable damper should be carried out or be approved by ACE.

### Model Type Prefix

#### Standard Models

MA: Self-Contained with return spring, adjustable  
ML: Self-Contained with return spring, adjustable, for lower impact velocity

#### Special Models

MAA, MLA: Air/Oil return without return spring.  
Use only with external air/oil tank.  
MAS, MLS: Air/Oil Return with return spring.  
Use only with external air/oil tank.  
MAN, MLN: Self-Contained without return spring

### Ordering Example

Adjustable \_\_\_\_\_ ↑  
Thread Size M33 \_\_\_\_\_ ↑  
Stroke 50 mm \_\_\_\_\_ ↑  
EU Compliant \_\_\_\_\_ ↑  
Metric Thread \_\_\_\_\_ ↑  
(omitted when using thread UNF 1 1/4-12)

MA/ML3350EUM

### Dimensions

| TYPES     | Stroke<br>mm | A max.<br>mm | L2<br>mm |
|-----------|--------------|--------------|----------|
| MA3325EUM | 23.2         | 138          | 83       |
| ML3325EUM | 23.2         | 138          | 83       |
| MA3350EUM | 48.6         | 189          | 108      |
| ML3350EUM | 48.6         | 189          | 108      |

### Performance

| TYPES     | Max. Energy Capacity                    |                        |   |  | Effective Weight           |                            | Return Force<br>min.<br>N | Return Force<br>max.<br>N | Return Time<br>s | Side Load<br>Angle max.<br>° | Weight<br>kg |
|-----------|---|------------------------|---|--|----------------------------|----------------------------|---------------------------|---------------------------|------------------|------------------------------|--------------|
|           | <sup>1</sup> W <sub>3</sub><br>Nm/cycle | W <sub>4</sub><br>Nm/h | W <sub>4</sub> with<br>Air/Oil Tank<br>Nm/h | W <sub>4</sub> with Oil<br>Recirculation<br>Nm/h | <sup>2</sup> me min.<br>kg | <sup>2</sup> me max.<br>kg |                           |                           |                  |                              |              |
| MA3325EUM | 170                                     | 75,000                 | 124,000                                     | 169,000  | 9                          | 1,700                      | 45                        | 90                        | 0.03             | 4                            | 0.51         |
| ML3325EUM | 170                                     | 75,000                 | 124,000                                     | 169,000  | 300                        | 50,000                     | 45                        | 90                        | 0.03             | 4                            | 0.51         |
| MA3350EUM | 340                                     | 85,000                 | 135,000                                     | 180,000  | 13                         | 2,500                      | 45                        | 135                       | 0.06             | 3                            | 0.62         |
| ML3350EUM | 340                                     | 85,000                 | 135,000                                     | 180,000  | 500                        | 80,000                     | 45                        | 135                       | 0.06             | 3                            | 0.62         |

<sup>1</sup> For emergency use only applications it is sometimes possible to exceed the above ratings. Please consult ACE for further details.

<sup>2</sup> The effective weight range limits can be raised or lowered to special order.

<sup>3</sup> For applications with higher side load angles consider using the side load adaptor (BV) pages 74 to 77.

Adjustable

**MA/ML45EUM**

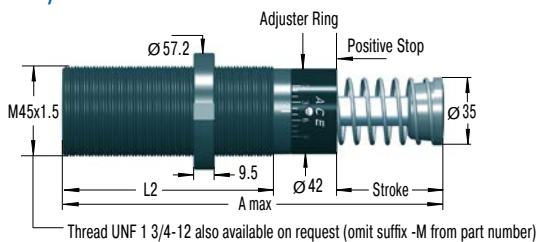

**NM45**  
Locking Ring

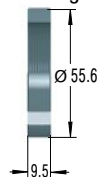

**QF45**  
Square Flange

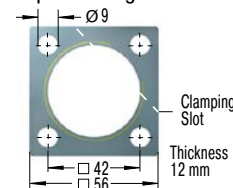

Torque max.: 27 Nm  
Clamping torque: > 200 Nm  
Install with 4 machine screws

The calculation and selection of the most suitable damper should be carried out or be approved by ACE.

**Model Type Prefix**

**Standard Models**

- MA: Self-Contained with return spring, adjustable
- ML: Self-Contained with return spring, adjustable, for lower impact velocity

**Special Models**

- MAA, MLA: Air/Oil return without return spring. Use only with external air/oil tank.
- MAS, MLS: Air/Oil Return with return spring. Use only with external air/oil tank.
- MAN, MLN: Self-Contained without return spring

**Ordering Example**

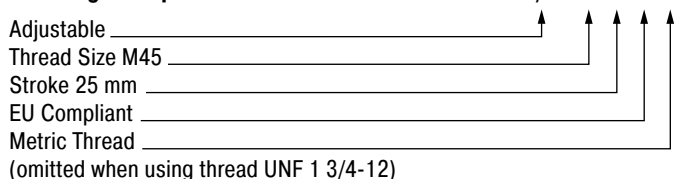

| Dimensions |              |              |          |
|------------|--------------|--------------|----------|
| TYPES      | Stroke<br>mm | A max.<br>mm | L2<br>mm |
| MA4525EUM  | 23.1         | 145          | 95       |
| ML4525EUM  | 23.1         | 145          | 95       |
| MA4550EUM  | 48.5         | 195          | 120      |
| ML4550EUM  | 48.5         | 195          | 120      |
| MA4575EUM  | 73.9         | 246          | 145      |

| Performance |   |                        |   |  |                            |                            |                           |                           |                  |                              |              |
|-------------|---|------------------------|---|--|----------------------------|----------------------------|---------------------------|---------------------------|------------------|------------------------------|--------------|
| TYPES       | Max. Energy Capacity                    |                        |   |  | Effective Weight           |                            | Return Force<br>min.<br>N | Return Force<br>max.<br>N | Return Time<br>s | Side Load<br>Angle max.<br>° | Weight<br>kg |
|             | <sup>1</sup> W <sub>3</sub><br>Nm/cycle | W <sub>4</sub><br>Nm/h | W <sub>4</sub> with<br>Air/Oil Tank<br>Nm/h | W <sub>4</sub> with Oil<br>Recirculation<br>Nm/h | <sup>2</sup> me min.<br>kg | <sup>2</sup> me max.<br>kg |                           |                           |                  |                              |              |
| MA4525EUM   | 425                                     | 107,000                | 158,000                                     | 192,000  | 40                         | 10,000                     | 70                        | 100                       | 0.03             | 4                            | 1.13         |
| ML4525EUM   | 425                                     | 107,000                | 158,000                                     | 192,000  | 3,000                      | 110,000                    | 70                        | 100                       | 0.03             | 4                            | 1.13         |
| MA4550EUM   | 850                                     | 112,000                | 192,000                                     | 248,000  | 70                         | 14,500                     | 70                        | 145                       | 0.08             | 3                            | 1.37         |
| ML4550EUM   | 850                                     | 112,000                | 192,000                                     | 248,000  | 5,000                      | 180,000                    | 70                        | 145                       | 0.08             | 3                            | 1.37         |
| MA4575EUM   | 1,300                                   | 146,000                | 225,000                                     | 282,000  | 70                         | 15,000                     | 50                        | 180                       | 0.11             | 2                            | 1.59         |

<sup>1</sup> For emergency use only applications it is sometimes possible to exceed the above ratings. Please consult ACE for further details.  
<sup>2</sup> The effective weight range limits can be raised or lowered to special order.  
<sup>3</sup> For applications with higher side load angles consider using the side load adaptor (BV) pages 74 to 77.



### MA/ML64EUM

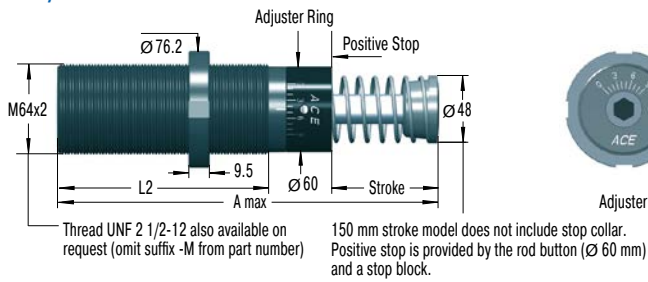

### NM64 Locking Ring

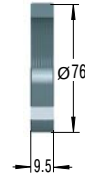

### QF64 Square Flange

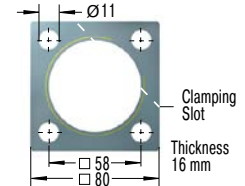

Torque max.: 50 Nm  
Clamping torque: > 210 Nm  
Install with 4 machine screws

The calculation and selection of the most suitable damper should be carried out or be approved by ACE.

### Model Type Prefix

#### Standard Models

- MA: Self-Contained with return spring, adjustable
- ML: Self-Contained with return spring, adjustable, for lower impact velocity

#### Special Models

- MAA, MLA: Air/Oil return without return spring. Use only with external air/oil tank.
- MAS, MLS: Air/Oil Return with return spring. Use only with external air/oil tank.
- MAN, MLN: Self-Contained without return spring

### Ordering Example

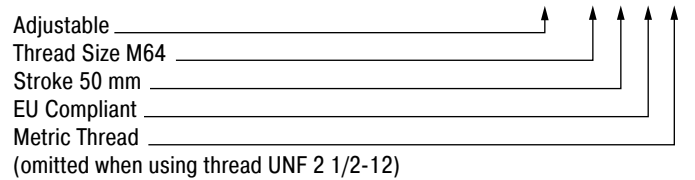

| Dimensions |              |              |          |
|------------|--------------|--------------|----------|
| TYPES      | Stroke<br>mm | A max.<br>mm | L2<br>mm |
| ML6425EUM  | 23.2         | 174          | 114      |
| MA6450EUM  | 48.6         | 225          | 140      |
| ML6450EUM  | 48.6         | 225          | 140      |
| MA64100EUM | 99.4         | 326          | 191      |
| MA64150EUM | 150          | 450          | 241      |

| Performance |   |                        |  |   |                            |                            |                           |                           |                  |                              |              |
|-------------|---|------------------------|--|---|----------------------------|----------------------------|---------------------------|---------------------------|------------------|------------------------------|--------------|
| TYPES       | Max. Energy Capacity                    |                        |  |   | Effective Weight           |                            | Return Force<br>min.<br>N | Return Force<br>max.<br>N | Return Time<br>s | Side Load<br>Angle max.<br>° | Weight<br>kg |
|             | <sup>1</sup> W <sub>3</sub><br>Nm/cycle | W <sub>4</sub><br>Nm/h | W <sub>4</sub> with Air/Oil Tank<br>Nm/h | W <sub>4</sub> with Oil Recirculation<br>Nm/h | <sup>2</sup> me min.<br>kg | <sup>2</sup> me max.<br>kg |                           |                           |                  |                              |              |
| ML6425EUM   | 1,135                                   | 124,000                | 248,000                                  | 332,000                                       | 7,000                      | 300,000                    | 120                       | 155                       | 0.06             | 5                            | 2.5          |
| MA6450EUM   | 2,275                                   | 146,000                | 293,000                                  | 384,000                                       | 220                        | 50,000                     | 90                        | 155                       | 0.12             | 4                            | 3.0          |
| ML6450EUM   | 2,275                                   | 146,000                | 293,000                                  | 384,000                                       | 11,000                     | 500,000                    | 90                        | 155                       | 0.12             | 4                            | 3.0          |
| MA64100EUM  | 4,520                                   | 192,000                | 384,000                                  | 497,000                                       | 270                        | 52,000                     | 105                       | 270                       | 0.34             | 3                            | 3.7          |
| MA64150EUM  | 6,780                                   | 248,000                | 497,000                                  | 644,000                                       | 330                        | 80,000                     | 75                        | 365                       | 0.48             | 2                            | 5.1          |

<sup>1</sup> For emergency use only applications it is sometimes possible to exceed the above ratings. Please consult ACE for further details.

<sup>2</sup> The effective weight range limits can be raised or lowered to special order.

<sup>3</sup> For applications with higher side load angles consider using the side load adaptor (BV) pages 74 to 77.



### M33x1.5

#### S33 Side Foot Mounting Kit

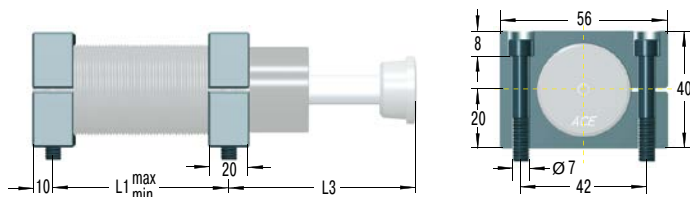

| Dimensions        |  | L1 min. | L1 max. | L3 |
|-------------------|--|---------|---------|----|
| TYPES             |  | mm      | mm      | mm |
| MC, MA, ML3325EUM |  | 25      | 60      | 68 |
| MC, MA, ML3350EUM |  | 32      | 86      | 93 |
| SC3325EUM         |  | 40      | 98      | 66 |
| SC3350EUM         |  | 60      | 153     | 92 |

S33 = 2 flanges + 4 screws M6x40, DIN 912  
 Torque max.: 11 Nm  
 Clamping torque: 90 Nm  
 Because of the thread pitch the fixing holes for the second foot mount should only be drilled and tapped after the first foot mount has been fixed in position.

#### C33 Clevis Mounting Kit

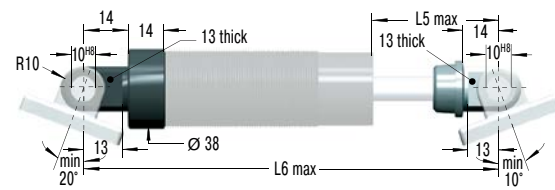

| Dimensions        |  | L5 max. | L6 max. |
|-------------------|--|---------|---------|
| TYPES             |  | mm      | mm      |
| MC, MA, ML3325EUM |  | 39      | 168     |
| MC, MA, ML3350EUM |  | 64      | 218     |
| SC3325EUM         |  | 39      | 208     |
| SC3350EUM         |  | 64      | 283     |

C33 = 2 clevis eyes. Delivered assembled to shock absorber.  
 Use positive stop at both ends of travel.

#### SF33 Clevis Flange

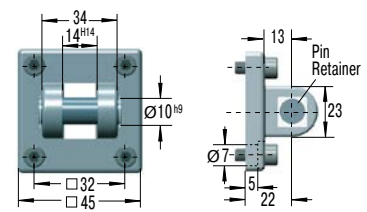

SF33 = flange + 4 screws M6x20, DIN 912  
 Torque max.: 7.5 Nm  
 Clamping torque: > 50 Nm  
**Secure with pin or use additional bar.**  
**Due to limited force capacity the respective ability should be reviewed by ACE.**

### M33x1.5

#### NM33 Locking Ring

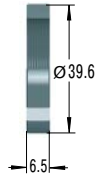

#### PP33 Poly Button

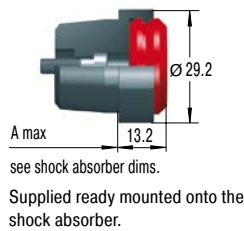

#### QF33 Square Flange

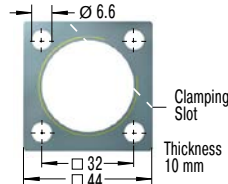

Torque max.: 11 Nm  
 Clamping torque: > 90 Nm  
 Install with 4 machine screws

#### AS33 Switch Stop Collar

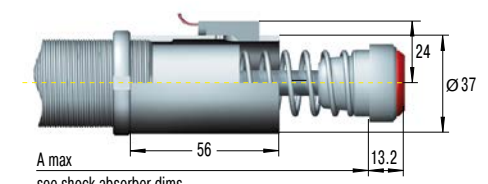

inc. Proximity Switch and Poly Button with elastomer insert

#### BV3325 Side Load Adaptor

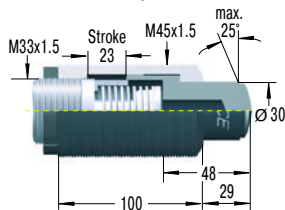

#### BV3350 Side Load Adaptor

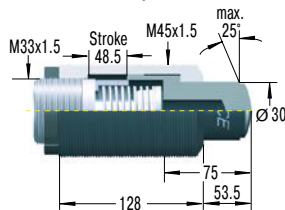

#### PB3325 Steel Shroud

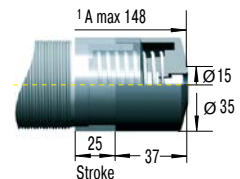

<sup>1</sup> Total installation length of the shock absorber inc. steel shroud

#### PB3350 Steel Shroud

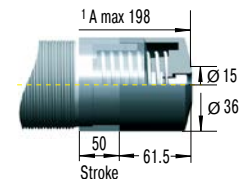

<sup>1</sup> Total installation length of the shock absorber inc. steel shroud

For mounting, installation, ..., see page 77.

### M45x1.5

#### S45 Side Foot Mounting Kit

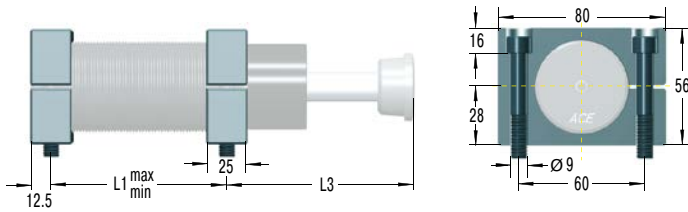

#### Dimensions

| TYPES             | L1 min. mm | L1 max. mm | L3 mm |
|-------------------|------------|------------|-------|
| MC, MA, ML4525EUM | 32         | 66         | 66    |
| MC, MA, ML4550EUM | 40         | 92         | 91    |
| MC, MA4575EUM     | 50         | 118        | 116   |
| SC4525EUM         | 50         | 112        | 62.5  |
| SC4550EUM         | 64         | 162        | 87.5  |

S45 = 2 flanges + 4 screws M8x50, DIN 912

Torque max.: 27 Nm

Clamping torque: 350 Nm

Because of the thread pitch the fixing holes for the second foot mount should only be drilled and tapped after the first foot mount has been fixed in position.

#### C45 Clevis Mounting Kit

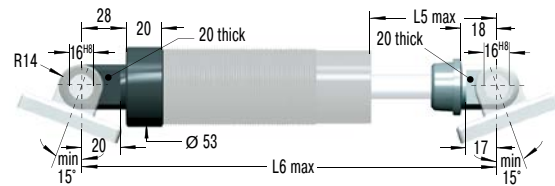

#### Dimensions

| TYPES             | L5 max. mm | L6 max. mm |
|-------------------|------------|------------|
| MC, MA, ML4525EUM | 43         | 200        |
| MC, MA, ML4550EUM | 68         | 250        |
| MC, MA4575EUM     | 93         | 301        |
| SC4525EUM         | 68         | 244        |
| SC4550EUM         | 93         | 320        |

C45 = 2 clevis eyes. Delivered assembled to shock absorber.

Use positive stop at both ends of travel.

#### SF45 Clevis Flange

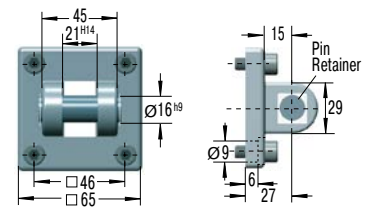

SF45 = flange + 4 screws M8x20, DIN 912

Torque max.: 7.5 Nm

Clamping torque: > 140 Nm

**Secure with pin or use additional bar.**

**Due to limited force capacity the respective ability should be reviewed by ACE.**

### M45x1.5

#### NM45 Locking Ring

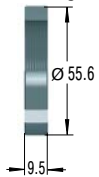

#### PP45 Poly Button

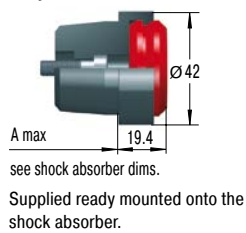

#### QF45 Square Flange

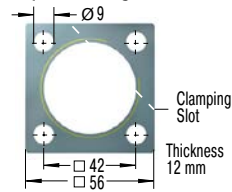

Torque max.: 27 Nm  
Clamping torque: > 200 Nm  
Install with 4 machine screws

#### AS45 Switch Stop Collar

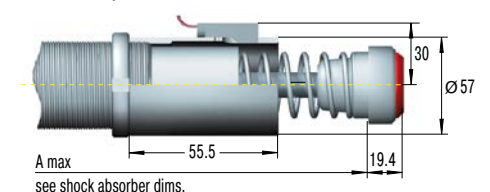

inc. Proximity Switch and Poly Button with elastomer insert

#### BV4525 Side Load Adaptor

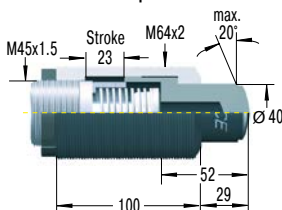

#### BV4550 Side Load Adaptor

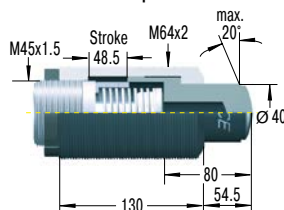

#### PB4525 Steel Shroud

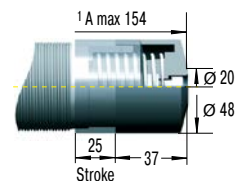

<sup>1</sup> Total installation length of the shock absorber inc. steel shroud

#### PB4550 Steel Shroud

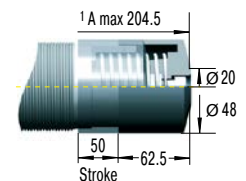

<sup>1</sup> Total installation length of the shock absorber inc. steel shroud

### M64x2

#### S64 Side Foot Mounting Kit

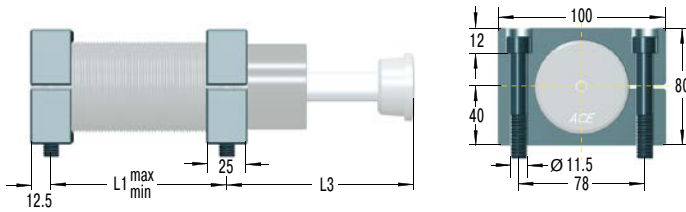

| Dimensions        |  | L1 min. | L1 max. | L3   |
|-------------------|--|---------|---------|------|
| TYPES             |  | mm      | mm      | mm   |
| ML6425EUM         |  | 40      | 86      | 75.5 |
| MC, MA, ML6450EUM |  | 50      | 112     | 100  |
| MC, MA64100EUM    |  | 64      | 162     | 152  |
| MC, MA64150EUM    |  | 80      | 212     | 226  |

S64 = 2 flanges + 4 screws M10x80, DIN 912  
 Torque max.: 50 Nm  
 Clamping torque: 350 Nm  
 Because of the thread pitch the fixing holes for the second foot mount should only be drilled and tapped after the first foot mount has been fixed in position.

#### C64 Clevis Mounting Kit

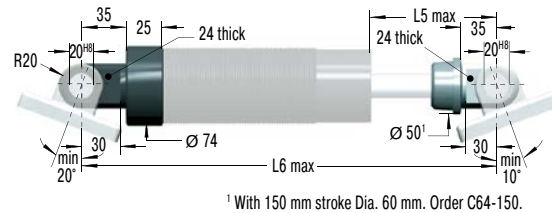

| Dimensions        |  | L5 max. | L6 max. |
|-------------------|--|---------|---------|
| TYPES             |  | mm      | mm      |
| ML6425EUM         |  | 60      | 260     |
| MC, MA, ML6450EUM |  | 85      | 310     |
| MC, MA64100EUM    |  | 136     | 410     |
| MC, MA64150EUM    |  | 187     | 530     |

C64 = 2 clevis eyes. Delivered assembled to shock absorber.  
 Use positive stop at both ends of travel.  
<sup>1</sup> With 150 mm stroke Dia. 60 mm. Order C64-150.

#### SF64 Clevis Flange

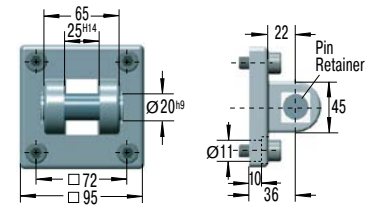

SF64 = flange + 4 screws M10x20, DIN 912  
 Torque max.: 15 Nm  
 Clamping torque: > 200 Nm  
**Secure with pin or use additional bar.**  
**Due to limited force capacity the respective ability should be reviewed by ACE.**

### M64x2

#### NM64 Locking Ring

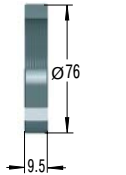

#### PP64 Poly Button

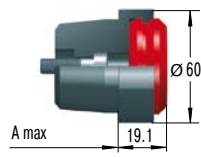

see shock absorber dims.  
 Supplied ready mounted onto the shock absorber.

#### QF64 Square Flange

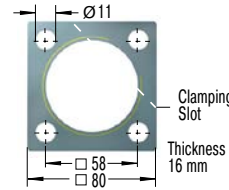

Torque max.: 50 Nm  
 Clamping torque: > 210 Nm  
 Install with 4 machine screws

#### QF90 Square Flange

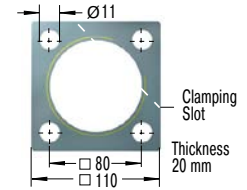

Torque max.: 50 Nm  
 Clamping torque: > 210 Nm  
 Install with 4 machine screws

#### BV6425 Side Load Adaptor

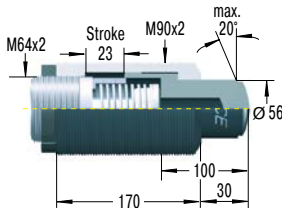

#### BV6450 Side Load Adaptor

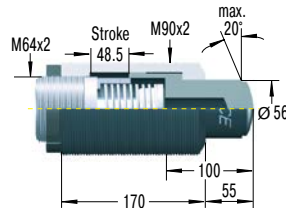

#### PB6425 Steel Shroud

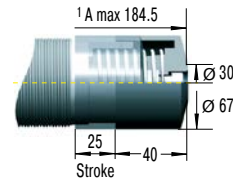

<sup>1</sup> Total installation length of the shock absorber inc. steel shroud

#### PB6450 Steel Shroud

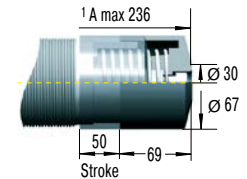

<sup>1</sup> Total installation length of the shock absorber inc. steel shroud

For mounting, installation, ..., see page 77.

### BV

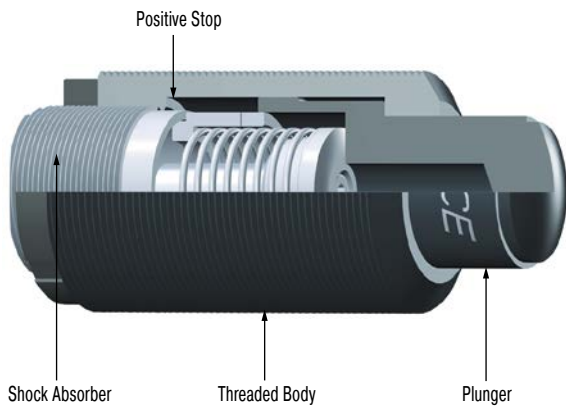

### Side Load Adaptor

For side load impact angles from 3° to 25°

With side load impact angles of more than 3° the operation lifetime of the shock absorber reduces rapidly due to increased wear of rod bearings. The optional BV side load adaptor provides long lasting solution.

#### Ordering information

- BV3325** (M45x1.5) for MC, MA, ML3325EUM (M33x1.5)
- BV3350** (M45x1.5) for MC, MA, ML3350EUM (M33x1.5)
- BV4525** (M64x2) for MC, MA, ML4525EUM (M45x1.5)
- BV4550** (M64x2) for MC, MA, ML4550EUM (M45x1.5)
- BV6425** (M90x2) for ML6425EUM (M64x2)
- BV6450** (M90x2) for MC, MA, ML6450EUM (M64x2)

#### Material

Threaded body and plunger: Hardened high tensile steel, hardened 610 HV1

#### Mounting information

Directly mount the shock absorber/side mount assembly on the outside thread of the side load adaptor or by using the QF flange. You cannot use a foot mount.

Calculation example and installation hints see page 45.

### PB

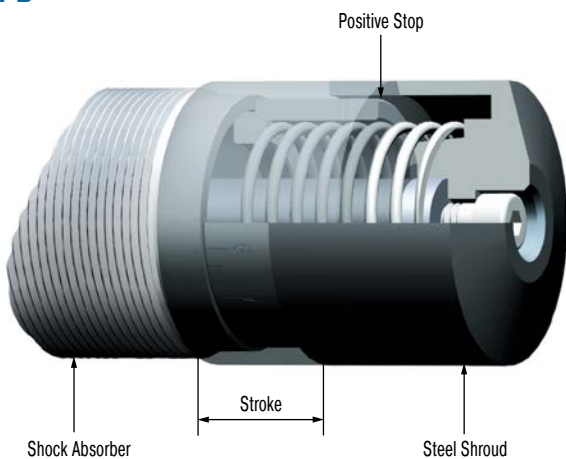

### Steel Shroud

For thread sizes M33x1.5, M45x1.5 and M64x2 with 25 or 50 mm stroke.

Grinding beads, sand, welding splatter, paints and adhesives etc. can adhere to the piston rod. They then damage the rod seals and the shock absorber quickly fails. In many cases the installation of the optional steel shroud can provide worthwhile protection and increase lifetime.

#### Material

Hardened high tensile steel

#### Mounting information

To mount the PB steel shroud it is necessary to remove the rod end button of the shock absorber.

#### Safety instructions

When installing don't forget to allow operating space for the shroud to move as the shock absorber is cycled.

### AS

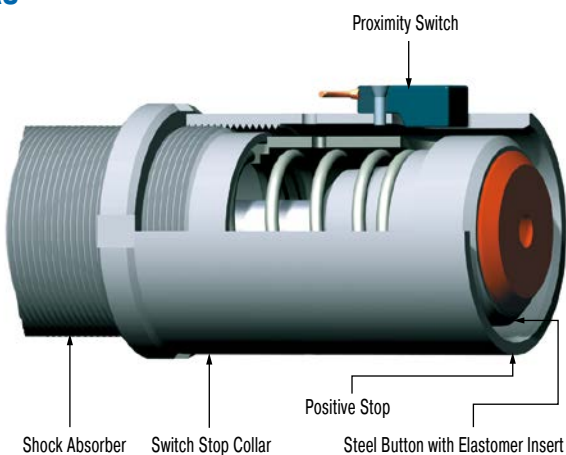

### Switch Stop Collar

For thread sizes M33x1.5 and M45x1.5

The ACE stop light switch stop collar combination serves as a safety element to provide stroke position information for automatically sequenced machines. The compact construction allows its use in nearly any application. The standard rod button is detected by the proximity switch at the end of its stroke to provide switch actuation. The switch is normally open when the shock absorber is extended and only closes when it has completed its operating stroke.

#### Material

Hardened high tensile steel

#### Delivery

The AS switch stop collar combination is only delivered ready mounted onto the shock absorber c/w the switch.

For circuit diagram of proximity switch see page 46.



## Application Examples

### MC33EUM

#### Quicker, gentle positioning

ACE industrial shock absorbers optimize portal for machine loading and increase productivity. This device driven by piston rodless pneumatic cylinders, in which two gripper slides are moving independently of each other at speeds of 2 to 2.5 m/sec., is equipped with industrial shock absorbers as brake systems. Their function is to stop a mass of 25 kg up to 540 times per hour. The model MC3350EUM-1-S was chosen for this application, allowing easy and extremely accurate adjustment of the end positions of the adjustable limit stops. In comparison to brake systems with other function principles, shock absorbers allow higher travel speeds and shorter cycle sequences.

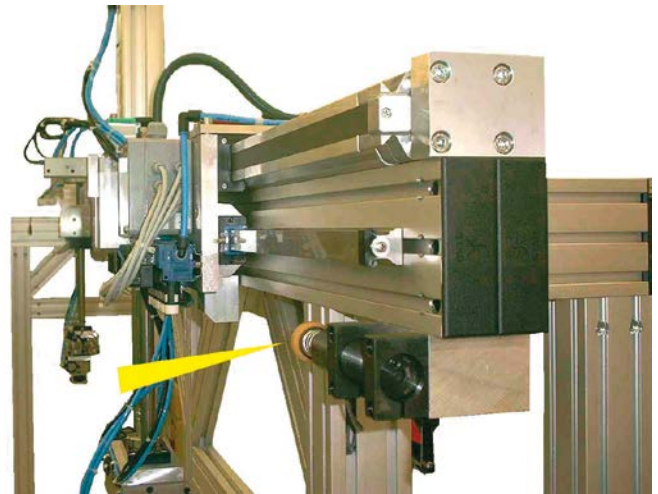
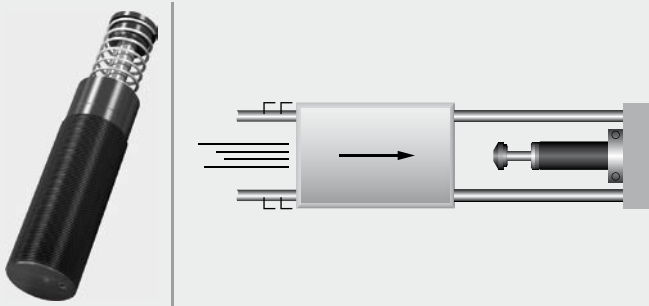

Industrial shock absorbers optimize portal operation

### MC45EUM

#### MAGNUM protection of carriage construction

Serving a similar purpose, several ACE dampers are installed in Jada, the triple-axis, free-moving badminton robot. In order for the badminton robot to be capable of playing, it must be able to change direction in the shortest time possible. Jada is designed therefore to brake at a maximum of 30 m/s<sup>2</sup>. For this task, linear modules are limited by the use of industrial shock absorbers of the type MC4575EUM-0. Miniature shock absorbers and profile dampers are also installed at the location of the "racket hand". In all cases, the modern ACE machine elements serve to protect the end positions of the construction.

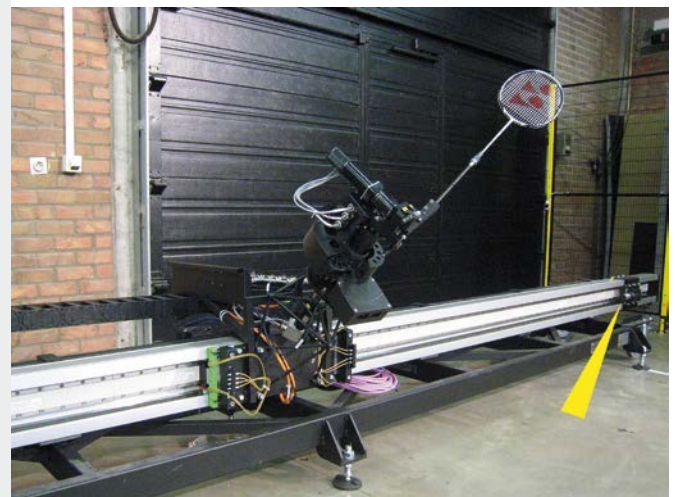
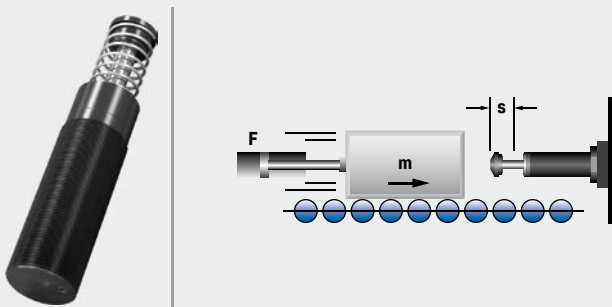

A variety of different dampers are used to slow the rapid movements of a badminton robot  
FMTC vzw, 3001 Leuven, Belgium

### MC64EUM-VA

#### MAGNUM damper for safety under water

A pipeline from the rig to the well head that is as flexible as possible is considered to be a quick-disconnect connection in an emergency. Nevertheless, this connection made at the oil source on the sea floor is an Achilles heel. If the connection snaps or if it cannot be separated quickly enough during hazards such as storms, unpredictable, often serious consequences can hardly be prevented. With the so-called XR connector, the safety at this critical point is significantly increased. In the innovative design 10 industrial shock absorbers per connection from the MAGNUM series from ACE master this important task.

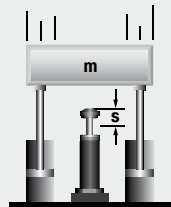

MAGNUMS allow for emergency quick disconnection of the pipelines from the oil rigs  
Subsea Technologies Ltd, Aberdeen, AB12 3AY, UK

### MA/ML33EUM

#### Safe swiveling

ACE industrial shock absorbers offer safety to spare for swiveling or braking of large telescope. The optical system of this telescope for special observations is moveable in two space coordinates. The structure in which the telescope is mounted weighs 15,000 kg and consists of a turntable with drives and two wheel disks rotating on bearings. It enables a rotation by  $\pm 90^\circ$  from horizon to horizon. To safeguard the telescope in case of overshooting the respective swiveling limits, industrial shock absorbers of the type ML3325EUM are used as braking elements. Should the telescope inadvertently overshoot the permissible swivel range, they will safely damp the travel of the valuable telescope.

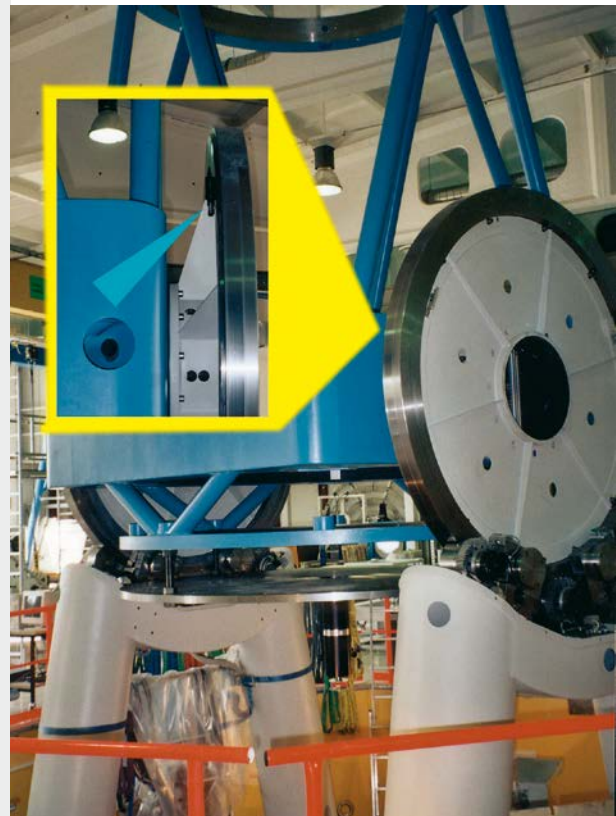
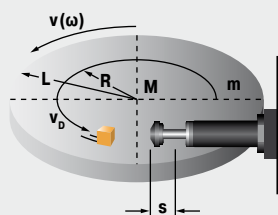

Perfect overshoot protection for precision telescope



# Heavy Industrial Shock Absorbers

## Effective shock absorption for heavy loads

The heavy industrial shock absorbers from ACE round off the top of the company's offers in damping technology. Designers also have the choice between self-compensating and adjustable machine elements in this category from ACE.

Whichever design is chosen, this type of shock absorber impresses with its robustness and operational readiness wherever heavy loads need reliably stopped on-the-spot at a precise point.

The CA4 models can absorb up to 126,500 Nm of energy. The series of heavy duty, self-compensating CA types are equally suitable for use as an emergency stop as the adjustable types with the designations A1 to A3. The range of effective loads covered is increased considerably for this purpose.



## Heavy Industrial Shock Absorbers



### CA2 to CA4

Self-Compensating

#### Deceleration of heavy loads

Portal systems, Machines and plants, Conveyor systems,  
Crane systems

Page 82



### A1½ to A3

Adjustable

#### Deceleration of heavy loads and progressive adjustment

Portal systems, Machines and plants, Conveyor systems,  
Crane systems

Page 86

Rugged and powerful

Gently stops heavy loads with high precision

Also ideal for emergency stop utilisation

Safe, reliable production

Maintenance-free and ready-to-install

Special versions available



## CA2 to CA4

### Deceleration of heavy loads

#### Self-Compensating

**Energy capacity 3,600 Nm/Cycle to 126,500 Nm/Cycle**

**Stroke 50 mm to 406 mm**

**Powerful:** The mass of these high volume absorbers are between 12.8 and 146 kg in weight. They complement ACE's product range of self-compensating shock absorbers. All models from this series are designed for applications where robustness and a large energy absorption are important.

The absorbers are designed specifically for each customer application with the aid of the ACE calculation program. The risk of crashes and incorrect settings are therefore prevented. The CA models can absorb up to 126,500 Nm of energy and can be used in the area of effective loads between 700 kg and 326,000 kg. The combination of being extremely solid, absorbing high levels of energy and having a large damping range makes them invaluable.

These heavy duty self-compensating industrial shock absorbers are primarily used in heavy mechanical engineering e.g. on lift bridges and steel structures or for damping sluice systems.

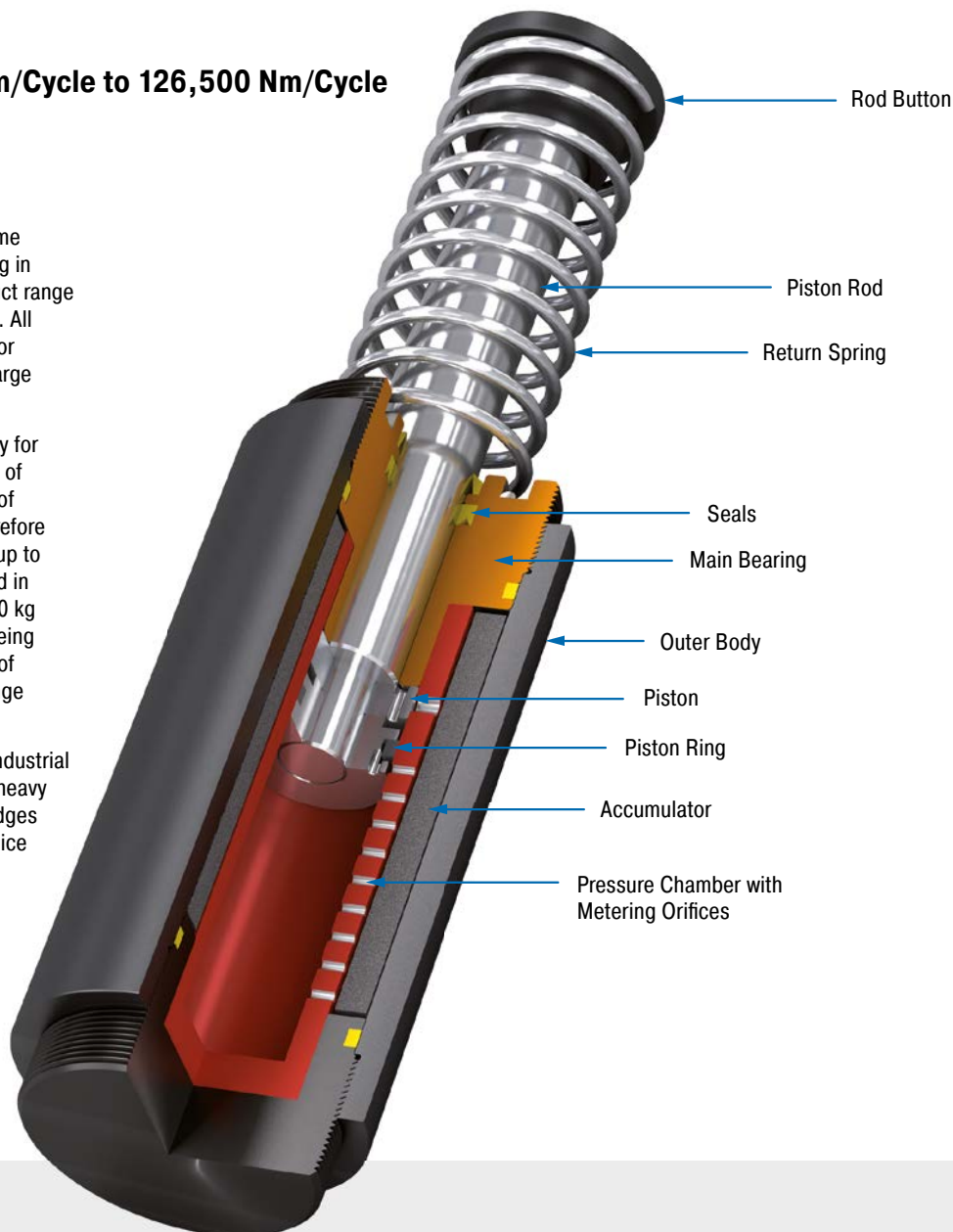

#### Technical Data

**Energy capacity:** 3,600 Nm/Cycle to 126,500 Nm/Cycle

**Impact velocity range:** 0.3 m/s to 5 m/s. Other speeds on request.

**Operating temperature range:** -12 °C to +66 °C. Other temperatures on request.

**Mounting:** In any position

**Positive stop:** External positive stops 2.5 mm to 3 mm before the end of stroke provided by the customer.

**Material:** Outer body: Steel corrosion-resistant coating; Piston rod: Hard chrome plated steel; Rod end button: Hardened steel and

corrosion-resistant coating; Return spring: Zinc plated steel

**Damping medium:** Automatic Transmission Fluid (ATF)

**Application field:** Portal systems, Machines and plants, Conveyor systems, Crane systems, Loading and lifting equipment, Shelf storage systems, Heavy load applications, Swivel units

**Note:** For emergency use only applications and for continuous use it is possible to exceed the published max. capacity ratings. In this case, please consult ACE.

**Safety instructions:** External materials in the surrounding area can attack the seal components and lead to a shorter service life. Please

contact ACE for appropriate solution suggestions. Do not paint the shock absorbers due to heat emission.

**On request:** Special oils, nickel-plated, increased corrosion protection or other special options are available on request.

### CA2EU-F Front Flange

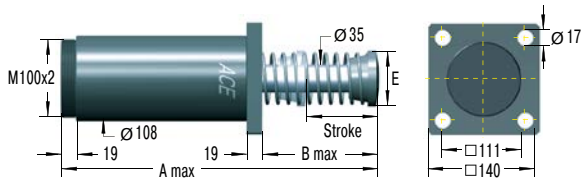

### CA2EU-R Rear Flange

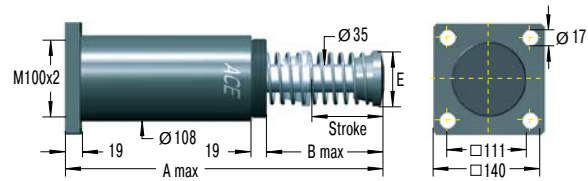

### CA2EU-SM Foot Mount

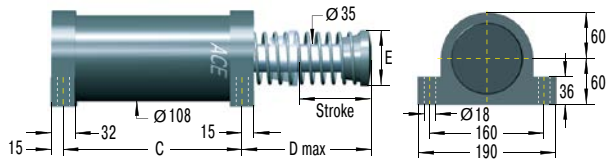

Clevis mounting available on request.

The calculation and selection of the most suitable damper should be carried out or be approved by ACE.

### Model Type Prefix

#### Standard Models

CA: Self-contained with return spring, self-compensating

#### Special Models

CAA: Air/Oil return without return spring.

Use only with external air/oil tank.

CNA: Self-Contained without return spring

CSA: Air/Oil return with return spring.

Use only with external air/oil tank.

### Ordering Example

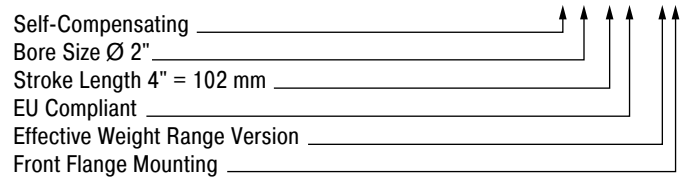

### Dimensions

| BASIC TYPES | Stroke<br>mm | A max.<br>mm | B max.<br>mm | C<br>mm | D max.<br>mm | E<br>mm |
|-------------|--------------|--------------|--------------|---------|--------------|---------|
| CA2X2EU     | 50           | 313          | 110          | 173     | 125          | 70      |
| CA2X4EU     | 102          | 414          | 160          | 224     | 175          | 70      |
| CA2X6EU     | 152          | 516          | 211          | 275     | 226          | 70      |
| CA2X8EU     | 203          | 643          | 287          | 326     | 302          | 92      |
| CA2X10EU    | 254          | 745          | 338          | 377     | 353          | 108     |

### Performance

| TYPES      | Max. Energy Capacity                    |                                     |  | Effective Weight           |                            |          | Return Force<br>min.<br>N | Return Force<br>max.<br>N | Return Time<br>s | Side Load Angle<br>max.<br>° | Weight<br>kg |
|------------|---|-------------------------------------|--|----------------------------|----------------------------|----------|---------------------------|---------------------------|------------------|------------------------------|--------------|
|            | <sup>1</sup> W <sub>3</sub><br>Nm/cycle | <sup>2</sup> W <sub>4</sub><br>Nm/h | <sup>2</sup> W <sub>4</sub> with<br>Air/Oil Tank<br>Nm/h | <sup>3</sup> me min.<br>kg | <sup>3</sup> me max.<br>kg | Hardness |                           |                           |                  |                              |              |
| CA2X2EU-1  | 3,600                                   | 1,100,000                           | 1,350,000  | 700                        | 2,200                      | -1       | 210                       | 285                       | 0.25             | 3                            | 14.3         |
| CA2X2EU-2  | 3,600                                   | 1,100,000                           | 1,350,000  | 1,800                      | 5,400                      | -2       | 210                       | 285                       | 0.25             | 3                            | 14.3         |
| CA2X2EU-3  | 3,600                                   | 1,100,000                           | 1,350,000  | 4,500                      | 13,000                     | -3       | 210                       | 285                       | 0.25             | 3                            | 14.3         |
| CA2X2EU-4  | 3,600                                   | 1,100,000                           | 1,350,000  | 11,300                     | 34,000                     | -4       | 210                       | 285                       | 0.25             | 3                            | 14.3         |
| CA2X4EU-1  | 7,200                                   | 1,350,000                           | 1,700,000  | 1,400                      | 4,400                      | -1       | 150                       | 285                       | 0.50             | 3                            | 16.7         |
| CA2X4EU-2  | 7,200                                   | 1,350,000                           | 1,700,000  | 3,600                      | 11,000                     | -2       | 150                       | 285                       | 0.50             | 3                            | 16.7         |
| CA2X4EU-3  | 7,200                                   | 1,350,000                           | 1,700,000  | 9,100                      | 27,200                     | -3       | 150                       | 285                       | 0.50             | 3                            | 16.7         |
| CA2X4EU-4  | 7,200                                   | 1,350,000                           | 1,700,000  | 22,600                     | 68,000                     | -4       | 150                       | 285                       | 0.50             | 3                            | 16.7         |
| CA2X6EU-1  | 10,800                                  | 1,600,000                           | 2,000,000  | 2,200                      | 6,500                      | -1       | 150                       | 400                       | 0.60             | 3                            | 19.3         |
| CA2X6EU-2  | 10,800                                  | 1,600,000                           | 2,000,000  | 5,400                      | 16,300                     | -2       | 150                       | 400                       | 0.60             | 3                            | 19.3         |
| CA2X6EU-3  | 10,800                                  | 1,600,000                           | 2,000,000  | 13,600                     | 40,800                     | -3       | 150                       | 400                       | 0.60             | 3                            | 19.3         |
| CA2X6EU-4  | 10,800                                  | 1,600,000                           | 2,000,000  | 34,000                     | 102,000                    | -4       | 150                       | 400                       | 0.60             | 3                            | 19.3         |
| CA2X8EU-1  | 14,500                                  | 1,900,000                           | 2,400,000  | 2,900                      | 8,700                      | -1       | 230                       | 650                       | 0.70             | 3                            | 22.3         |
| CA2X8EU-2  | 14,500                                  | 1,900,000                           | 2,400,000  | 7,200                      | 21,700                     | -2       | 230                       | 650                       | 0.70             | 3                            | 22.3         |
| CA2X8EU-3  | 14,500                                  | 1,900,000                           | 2,400,000  | 18,100                     | 54,400                     | -3       | 230                       | 650                       | 0.70             | 3                            | 22.3         |
| CA2X8EU-4  | 14,500                                  | 1,900,000                           | 2,400,000  | 45,300                     | 136,000                    | -4       | 230                       | 650                       | 0.70             | 3                            | 22.3         |
| CA2X10EU-1 | 18,000                                  | 2,200,000                           | 2,700,000  | 3,600                      | 11,000                     | -1       | 160                       | 460                       | 0.80             | 3                            | 32.3         |
| CA2X10EU-2 | 18,000                                  | 2,200,000                           | 2,700,000  | 9,100                      | 27,200                     | -2       | 160                       | 460                       | 0.80             | 3                            | 32.3         |
| CA2X10EU-3 | 18,000                                  | 2,200,000                           | 2,700,000  | 22,600                     | 68,000                     | -3       | 160                       | 460                       | 0.80             | 3                            | 32.3         |
| CA2X10EU-4 | 18,000                                  | 2,200,000                           | 2,700,000  | 56,600                     | 170,000                    | -4       | 160                       | 460                       | 0.80             | 3                            | 32.3         |

<sup>1</sup> For emergency use only applications it is sometimes possible to exceed the above ratings. Please consult ACE for further details.

<sup>2</sup> Figures for oil recirculation systems on request.

<sup>3</sup> The effective weight range limits can be raised or lowered to special order.

Self-Compensating

CA3EU-F Front Flange

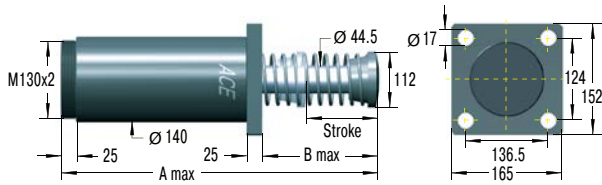

CA3EU-R Rear Flange

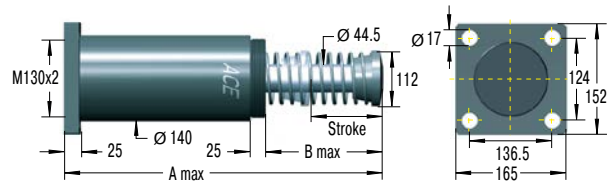

CA3EU-S Foot Mount

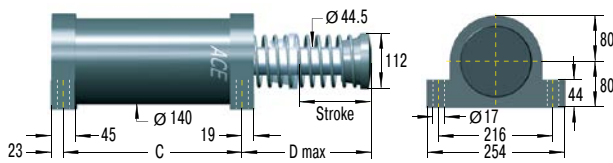

Clevis mounting available on request.

The calculation and selection of the most suitable damper should be carried out or be approved by ACE.

Model Type Prefix

Standard Models

CA: Self-contained with return spring, self-compensating

Special Models

CAA: Air/Oil return without return spring.

Use only with external air/oil tank.

CNA: Self-Contained without return spring

CSA: Air/Oil return with return spring.

Use only with external air/oil tank.

Ordering Example

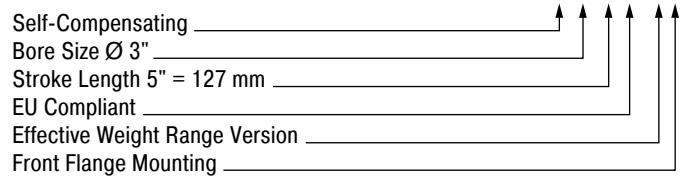

Dimensions

| BASIC TYPES | Stroke<br>mm | A max.<br>mm | B max.<br>mm | C<br>mm | D max.<br>mm |
|-------------|--------------|--------------|--------------|---------|--------------|
| CA3X5EU     | 127          | 490.5        | 211          | 254     | 224          |
| CA3X8EU     | 203          | 641          | 286          | 330     | 300          |
| CA3X12EU    | 305          | 890          | 434          | 432     | 447          |

Performance

| TYPES      | Max. Energy Capacity                    |                                     |  | Effective Weight           |                            |          | Return Force<br>min.<br>N | Return Force<br>max.<br>N | Return Time<br>s | Side Load Angle<br>max.<br>° | Weight<br>kg |
|------------|---|-------------------------------------|--|----------------------------|----------------------------|----------|---------------------------|---------------------------|------------------|------------------------------|--------------|
|            | <sup>1</sup> W <sub>3</sub><br>Nm/cycle | <sup>2</sup> W <sub>4</sub><br>Nm/h | <sup>2</sup> W <sub>4</sub> with<br>Air/Oil Tank<br>Nm/h | <sup>3</sup> me min.<br>kg | <sup>3</sup> me max.<br>kg | Hardness |                           |                           |                  |                              |              |
| CA3X5EU-1  | 14,125                                  | 2,260,000                           | 2,800,000  | 2,900                      | 8,700                      | -1       | 270                       | 710                       | 0.6              | 3                            | 32.7         |
| CA3X5EU-2  | 14,125                                  | 2,260,000                           | 2,800,000  | 7,250                      | 21,700                     | -2       | 270                       | 710                       | 0.6              | 3                            | 32.7         |
| CA3X5EU-3  | 14,125                                  | 2,260,000                           | 2,800,000  | 18,100                     | 54,350                     | -3       | 270                       | 710                       | 0.6              | 3                            | 32.7         |
| CA3X5EU-4  | 14,125                                  | 2,260,000                           | 2,800,000  | 45,300                     | 135,900                    | -4       | 270                       | 710                       | 0.6              | 3                            | 32.7         |
| CA3X8EU-1  | 22,600                                  | 3,600,000                           | 4,520,000  | 4,650                      | 13,900                     | -1       | 280                       | 740                       | 0.8              | 3                            | 38.5         |
| CA3X8EU-2  | 22,600                                  | 3,600,000                           | 4,520,000  | 11,600                     | 34,800                     | -2       | 280                       | 740                       | 0.8              | 3                            | 38.5         |
| CA3X8EU-3  | 22,600                                  | 3,600,000                           | 4,520,000  | 29,000                     | 87,000                     | -3       | 280                       | 740                       | 0.8              | 3                            | 38.5         |
| CA3X8EU-4  | 22,600                                  | 3,600,000                           | 4,520,000  | 72,500                     | 217,000                    | -4       | 280                       | 740                       | 0.8              | 3                            | 38.5         |
| CA3X12EU-1 | 33,900                                  | 5,400,000                           | 6,780,000  | 6,950                      | 20,900                     | -1       | 270                       | 730                       | 1.2              | 3                            | 47.6         |
| CA3X12EU-2 | 33,900                                  | 5,400,000                           | 6,780,000  | 17,400                     | 52,200                     | -2       | 270                       | 730                       | 1.2              | 3                            | 47.6         |
| CA3X12EU-3 | 33,900                                  | 5,400,000                           | 6,780,000  | 43,500                     | 130,450                    | -3       | 270                       | 730                       | 1.2              | 3                            | 47.6         |
| CA3X12EU-4 | 33,900                                  | 5,400,000                           | 6,780,000  | 108,700                    | 326,000                    | -4       | 270                       | 730                       | 1.2              | 3                            | 47.6         |

<sup>1</sup> For emergency use only applications it is sometimes possible to exceed the above ratings. Please consult ACE for further details.

<sup>2</sup> Figures for oil recirculation systems on request.

<sup>3</sup> The effective weight range limits can be raised or lowered to special order.

### CA4EU-F Front Flange

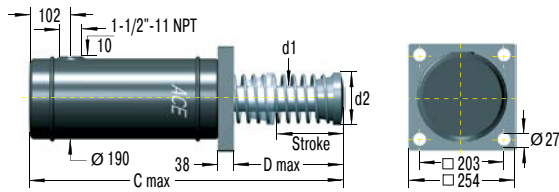

### CA4EU-R Rear Flange

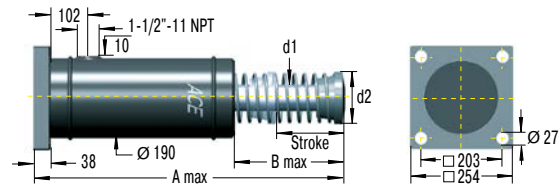

### CA4EU-FRP 6 Tapped Holes

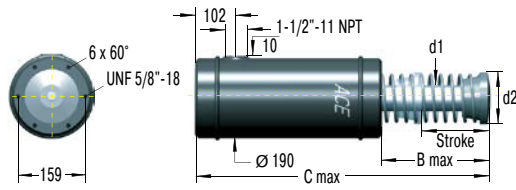

Clevis mounting available on request.

### CA4EU-S Foot Mount

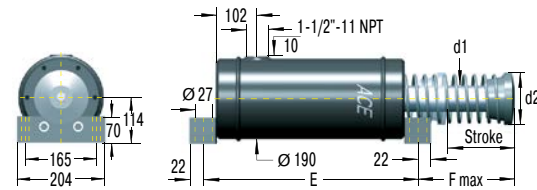

Clevis mounting available on request.

The calculation and selection of the most suitable damper should be carried out or be approved by ACE.

### Model Type Prefix

#### Standard Models

CA: Self-contained with return spring, self-compensating

#### Special Models

CAA: Air/Oil return without return spring.

Use only with external air/oil tank.

CNA: Self-Contained without return spring

CSA: Air/Oil return with return spring.

Use only with external air/oil tank.

### Ordering Example

Self-Compensating  **CA4x8EU-5R**  
 Bore Size Ø 4"   
 Stroke Length 8" = 203 mm   
 EU Compliant   
 Effective Weight Range Version   
 Rear Flange Mounting

### Dimensions

|             | Stroke | A max. | B max. | C max.  | D max. | d1   | d2  | E   | F   |
|-------------|--------|--------|--------|---------|--------|------|-----|-----|-----|
| BASIC TYPES | mm     | mm     | mm     | mm      | mm     | mm   | mm  | mm  | mm  |
| CA4X6EU     | 152    | 716    | 278    | 678     | 240    | 54   | 114 | 444 | 256 |
| CA4X8EU     | 203    | 818    | 329    | 780     | 291    | 54   | 114 | 495 | 307 |
| CA4X16EU    | 406    | 1,300  | 608.5  | 1,262.6 | 569    | 63.5 | 127 | 698 | 585 |

### Performance

| TYPES      | Max. Energy Capacity                 |                     |                                       |  | Effective Weight        |                         |          | Return Force min. N | Return Force max. N | Return Time s | Weight kg |
|------------|--------------------------------------|---------------------|---------------------------------------|--|-------------------------|-------------------------|----------|---------------------|---------------------|---------------|-----------|
|            | <sup>1</sup> W <sub>3</sub> Nm/cycle | W <sub>4</sub> Nm/h | W <sub>4</sub> with Air/Oil Tank Nm/h | W <sub>4</sub> with Oil Recirculation Nm/h | <sup>2</sup> me min. kg | <sup>2</sup> me max. kg | Hardness |                     |                     |               |           |
| CA4X6EU-3  | 47,500                               | 3,000,000           | 5,100,000                             | 6,600,000                                  | 3,500                   | 8,600                   | -3       | 480                 | 1,000               | 1.8           | 60        |
| CA4X6EU-5  | 47,500                               | 3,000,000           | 5,100,000                             | 6,600,000                                  | 8,600                   | 18,600                  | -5       | 480                 | 1,000               | 1.8           | 60        |
| CA4X6EU-7  | 47,500                               | 3,000,000           | 5,100,000                             | 6,600,000                                  | 18,600                  | 42,700                  | -7       | 480                 | 1,000               | 1.8           | 60        |
| CA4X8EU-3  | 63,300                               | 3,400,000           | 5,600,000                             | 7,300,000                                  | 5,000                   | 11,400                  | -3       | 310                 | 1,000               | 2.3           | 68        |
| CA4X8EU-5  | 63,300                               | 3,400,000           | 5,600,000                             | 7,300,000                                  | 11,400                  | 25,000                  | -5       | 310                 | 1,000               | 2.3           | 68        |
| CA4X8EU-7  | 63,300                               | 3,400,000           | 5,600,000                             | 7,300,000                                  | 25,000                  | 57,000                  | -7       | 310                 | 1,000               | 2.3           | 68        |
| CA4X16EU-3 | 126,500                              | 5,600,000           | 9,600,000                             | 12,400,000                                 | 10,000                  | 23,000                  | -3       | 310                 | 1,000               | ask           | 146       |
| CA4X16EU-5 | 126,500                              | 5,600,000           | 9,600,000                             | 12,400,000                                 | 23,000                  | 50,000                  | -5       | 310                 | 1,000               | ask           | 146       |
| CA4X16EU-7 | 126,500                              | 5,600,000           | 9,600,000                             | 12,400,000                                 | 50,000                  | 115,000                 | -7       | 310                 | 1,000               | ask           | 146       |

<sup>1</sup> For emergency use only applications it is sometimes possible to exceed the above ratings. Please consult ACE for further details.

<sup>2</sup> The effective weight range limits can be raised or lowered to special order.



## A1½ to A3

### Deceleration of heavy loads and progressive adjustment

#### Adjustable

**Energy capacity 2,350 Nm/Cycle to 44,000 Nm/Cycle**  
**Stroke 50 mm to 305 mm**

Strong and adjustable: Also in ACE's range of units are heavy duty industrial shock absorbers, which can be adjusted. The models from the A1½ to A3 range, which weigh between 7.55 kg and 48 kg, are extremely robust, ready-to-install hydraulic machine elements with impressively high energy absorption levels and a wide range of damping rates.

Their special aspect is the flexibility, as all the absorbers can be adjusted using a socket on the absorber base and be perfectly adapted to the required data. The A models cover a range of effective loads from 0.3 kg to 204,000 kg and can absorb up to 44,000 Nm energy.

These heavy duty, adjustable ACE industrial shock absorbers are the first choice in heavy duty applications and generally in heavy mechanical engineering when the usage data has not been exactly determined.

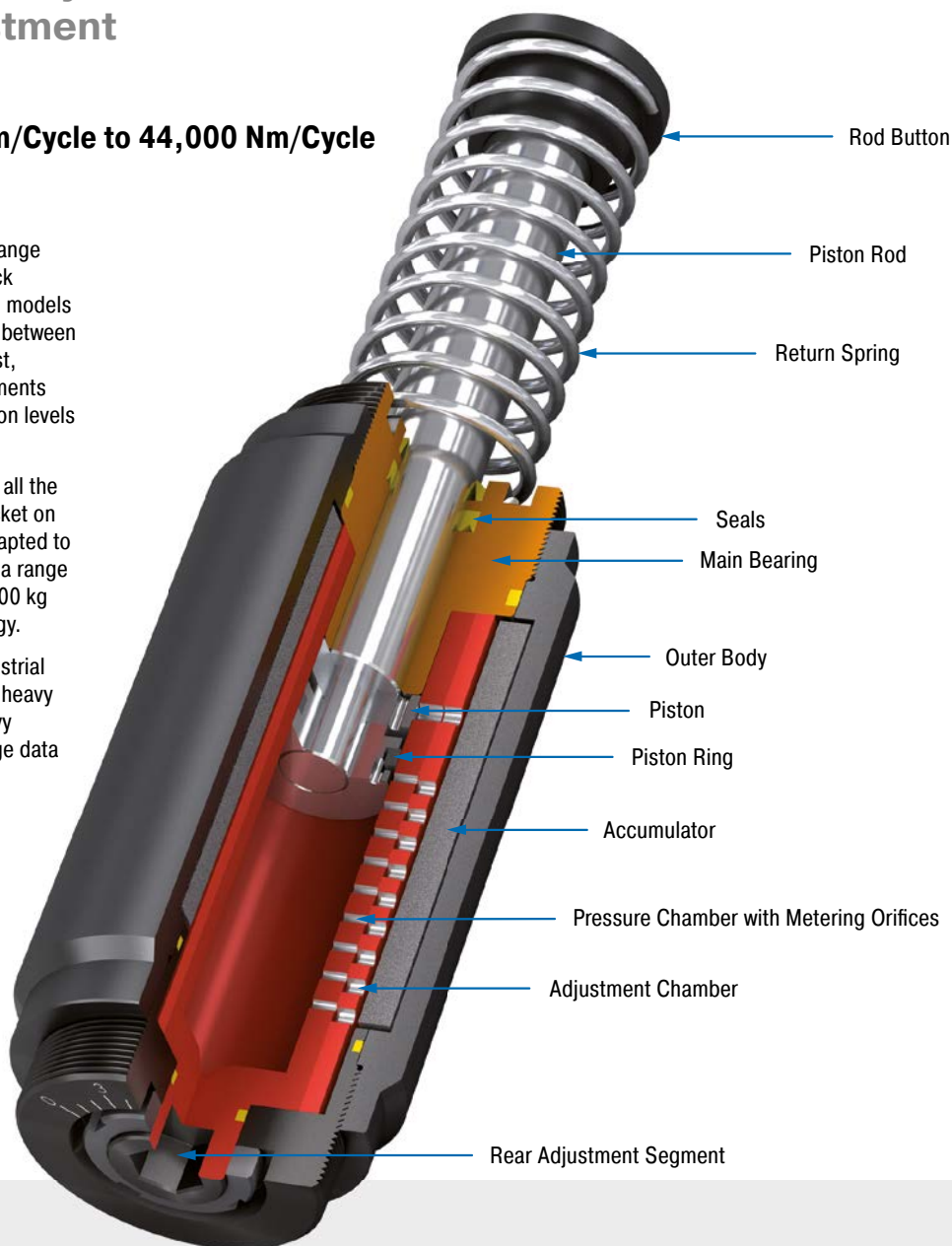

#### Technical Data

**Energy capacity:** 2,350 Nm/Cycle to 44,000 Nm/Cycle

**Impact velocity range:** 0.1 m/s to 5 m/s. Other speeds on request.

**Operating temperature range:** -12 °C to +66 °C. Other temperatures on request.

**Mounting:** In any position

**Positive stop:** External positive stops 2.5 mm to 3 mm before the end of stroke provided by the customer.

**Adjustment:** Hard impact at the start of stroke, adjust the ring towards 9. Hard impact at the end of stroke, adjust the ring towards 0.

**Material:** Outer body: Steel corrosion-resistant coating; Piston rod: Hard chrome plated steel; Rod end button: Hardened steel and corrosion-resistant coating; Return spring: Zinc plated steel

**Damping medium:** Automatic Transmission Fluid (ATF)

**Application field:** Portal systems, Machines and plants, Conveyor systems, Crane systems, Loading and lifting equipment, Impact panels, Heavy load applications, Swivel units, Shelf storage systems

**Note:** For emergency use only applications and for continuous use it is possible to exceed

the published max. capacity ratings. In this case, please consult ACE.

**Safety instructions:** External materials in the surrounding area can attack the seal components and lead to a shorter service life. Please contact ACE for appropriate solution suggestions. Do not paint the shock absorbers due to heat emission.

**On request:** Special oils, nickel-plated, increased corrosion protection or other special options are available on request.

### A1½EU-F Front Flange

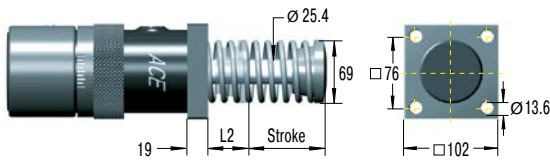

### A1½EU-R Rear Flange

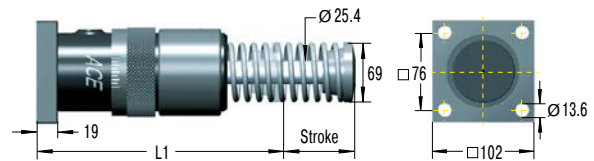

### A1½EU-C Clevis Mount

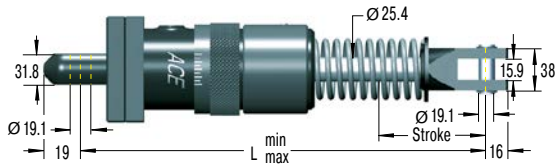

### A1½EU-S Foot Mount

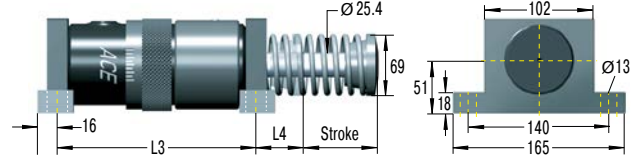

The calculation and selection of the most suitable damper should be carried out or be approved by ACE.

### Model Type Prefix

#### Standard Models

A: Self-contained with return spring, adjustable

#### Special Models

AA: Air/Oil return without return spring.

Use only with external air/oil tank.

NA: Self-contained without return spring

SA: Air/Oil return with return spring.

Use only with external air/oil tank.

### Ordering Example

Adjustable \_\_\_\_\_ ↑ ↑ ↑ ↑ ↑  
 Bore Size Ø 1½" \_\_\_\_\_ ↑ ↑ ↑ ↑ ↑  
 Stroke Length 2" = 50.8 mm \_\_\_\_\_ ↑ ↑ ↑ ↑ ↑  
 EU Compliant \_\_\_\_\_ ↑ ↑ ↑ ↑ ↑  
 Rear Flange Mounting \_\_\_\_\_ ↑ ↑ ↑ ↑ ↑

**A1½x2EUR**

### Dimensions

| TYPES    | Stroke<br>mm | L min.<br>mm | L max.<br>mm | L1<br>mm | L2<br>mm | L3<br>mm | L4<br>mm |
|----------|--------------|--------------|--------------|----------|----------|----------|----------|
| A1½X2EU  | 50           | 277.8        | 328.6        | 195.2    | 54.2     | -        | -        |
| A1½X3½EU | 89           | 316.6        | 405.6        | 233      | 54.2     | 170      | 58.6     |
| A1½X5EU  | 127          | 354.8        | 481.8        | 271.5    | 54.2     | 208      | 58.6     |
| A1½X6½EU | 165          | 412          | 577          | 329      | 73       | 246      | 78       |

### Performance

| TYPES    | Max. Energy Capacity                    |                                     |  | Effective Weight           |                            | Return Force<br>min.<br>N | Return Force<br>max.<br>N | Return Time<br>s | Side Load Angle<br>max.<br>° | Weight<br>kg |
|----------|---|-------------------------------------|--|----------------------------|----------------------------|---------------------------|---------------------------|------------------|------------------------------|--------------|
|          | <sup>1</sup> W <sub>3</sub><br>Nm/cycle | <sup>2</sup> W <sub>4</sub><br>Nm/h | <sup>2</sup> W <sub>4</sub> with<br>Air/Oil Tank<br>Nm/h | <sup>3</sup> me min.<br>kg | <sup>3</sup> me max.<br>kg |                           |                           |                  |                              |              |
| A1½X2EU  | 2,350                                   | 362,000                             | 452,000  | 195                        | 32,000                     | 160                       | 210                       | 0.10             | 5                            | 7.6          |
| A1½X3½EU | 4,150                                   | 633,000                             | 791,000  | 218                        | 36,000                     | 110                       | 210                       | 0.25             | 4                            | 8.9          |
| A1½X5EU  | 5,900                                   | 904,000                             | 1,130,000  | 227                        | 41,000                     | 90                        | 230                       | 0.40             | 3                            | 9.4          |
| A1½X6½EU | 7,700                                   | 1,180,000                           | 1,469,000  | 308                        | 45,000                     | 90                        | 430                       | 0.40             | 2                            | 12.0         |

<sup>1</sup> For emergency use only applications it is sometimes possible to exceed the above ratings. Please consult ACE for further details.

<sup>2</sup> Figures for oil recirculation systems on request.

<sup>3</sup> The effective weight range limits can be raised or lowered to special order.

Adjustable

**A2EU-F Front Flange**

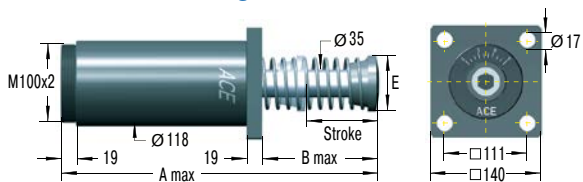

**A2EU-R Rear Flange**

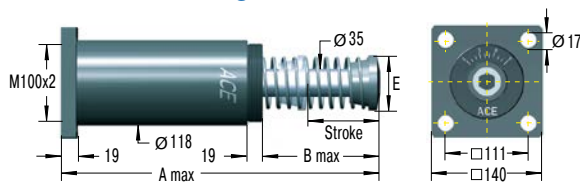

**A2EU-SM Foot Mount**

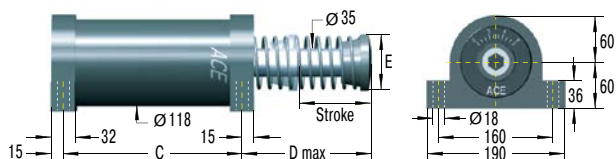

The calculation and selection of the most suitable damper should be carried out or be approved by ACE.

**Model Type Prefix**

**Standard Models**

A: Self-contained with return spring, adjustable

**Special Models**

AA: Air/Oil return without return spring.

Use only with external air/oil tank.

NA: Self-contained without return spring

SA: Air/Oil return with return spring.

Use only with external air/oil tank.

**Ordering Example**

Adjustable \_\_\_\_\_ **A2x6EU-R**  
 Bore Size Ø 2" \_\_\_\_\_  
 Stroke Length 6" = 152 mm \_\_\_\_\_  
 EU Compliant \_\_\_\_\_  
 Rear Flange Mounting \_\_\_\_\_

**Dimensions**

| TYPES   | Stroke<br>mm | A max.<br>mm | B max.<br>mm | C<br>mm | D max.<br>mm | E<br>mm |
|---------|--------------|--------------|--------------|---------|--------------|---------|
| A2X2EU  | 50           | 313          | 110          | 173     | 125          | 70      |
| A2X4EU  | 102          | 414          | 160          | 224     | 175          | 70      |
| A2X6EU  | 152          | 516          | 211          | 275     | 226          | 70      |
| A2X8EU  | 203          | 643          | 287          | 326     | 302          | 92      |
| A2X10EU | 254          | 745          | 338          | 377     | 353          | 108     |

**Performance**

| TYPES   | Max. Energy Capacity                    |                                     |  | Effective Weight           |                            | Return Force<br>min.<br>N | Return Force<br>max.<br>N | Return Time<br>s | Side Load Angle<br>max.<br>° | Weight<br>kg |
|---------|---|-------------------------------------|--|----------------------------|----------------------------|---------------------------|---------------------------|------------------|------------------------------|--------------|
|         | <sup>1</sup> W <sub>3</sub><br>Nm/cycle | <sup>2</sup> W <sub>4</sub><br>Nm/h | <sup>2</sup> W <sub>4</sub> with<br>Air/Oil Tank<br>Nm/h | <sup>3</sup> me min.<br>kg | <sup>3</sup> me max.<br>kg |                           |                           |                  |                              |              |
| A2X2EU  | 3,600                                   | 1,100,000                           | 1,350,000  | 250                        | 77,000                     | 210                       | 285                       | 0.25             | 3                            | 14.3         |
| A2X4EU  | 9,000                                   | 1,350,000                           | 1,700,000  | 250                        | 82,000                     | 150                       | 285                       | 0.50             | 3                            | 16.7         |
| A2X6EU  | 13,500                                  | 1,600,000                           | 2,000,000  | 260                        | 86,000                     | 150                       | 400                       | 0.60             | 3                            | 19.3         |
| A2X8EU  | 19,200                                  | 1,900,000                           | 2,400,000  | 260                        | 90,000                     | 230                       | 650                       | 0.70             | 3                            | 22.3         |
| A2X10EU | 23,700                                  | 2,200,000                           | 2,700,000  | 320                        | 113,000                    | 160                       | 460                       | 0.80             | 3                            | 26.2         |

<sup>1</sup> For emergency use only applications it is sometimes possible to exceed the above ratings. Please consult ACE for further details.

<sup>2</sup> Figures for oil recirculation systems on request.

<sup>3</sup> The effective weight range limits can be raised or lowered to special order.

### A3EU-F Front Flange

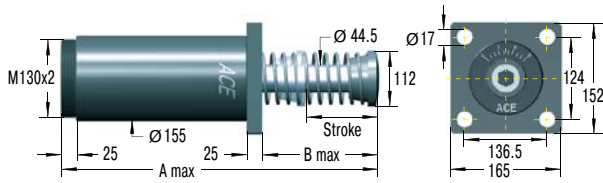

### A3EU-R Rear Flange

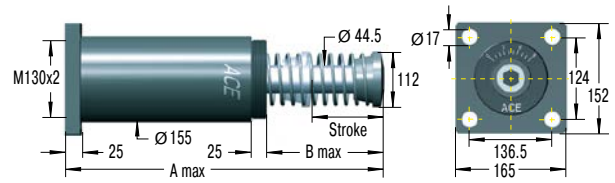

### A3EU-S Foot Mount

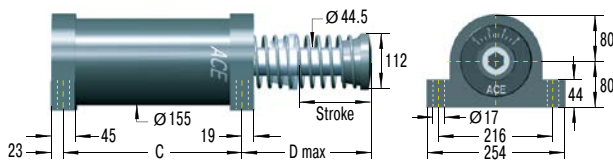

The calculation and selection of the most suitable damper should be carried out or be approved by ACE.

### Model Type Prefix

#### Standard Models

A: Self-contained with return spring, adjustable

#### Special Models

AA: Air/Oil return without return spring.

Use only with external air/oil tank.

NA: Self-contained without return spring

SA: Air/Oil return with return spring.

Use only with external air/oil tank.

### Ordering Example

Adjustable \_\_\_\_\_ **A3x8EUR**  
 Bore Size Ø 3" \_\_\_\_\_  
 Stroke Length 8" = 203 mm \_\_\_\_\_  
 EU Compliant \_\_\_\_\_  
 Rear Flange Mounting \_\_\_\_\_

### Dimensions

| TYPES   | Stroke<br>mm | A max.<br>mm | B max.<br>mm | C<br>mm | D max.<br>mm |
|---------|--------------|--------------|--------------|---------|--------------|
| A3X5EU  | 127          | 490.5        | 211          | 254     | 224          |
| A3X8EU  | 203          | 641          | 286          | 330     | 300          |
| A3X12EU | 305          | 890          | 434          | 432     | 447          |

### Performance

| TYPES   | Max. Energy Capacity                    |                                     |  | Effective Weight           |                            | Return Force<br>min.<br>N | Return Force<br>max.<br>N | Return Time<br>s | Side Load Angle<br>max.<br>° | Weight<br>kg |
|---------|---|-------------------------------------|--|----------------------------|----------------------------|---------------------------|---------------------------|------------------|------------------------------|--------------|
|         | <sup>1</sup> W <sub>3</sub><br>Nm/cycle | <sup>2</sup> W <sub>4</sub><br>Nm/h | <sup>2</sup> W <sub>4</sub> with<br>Air/Oil Tank<br>Nm/h | <sup>3</sup> me min.<br>kg | <sup>3</sup> me max.<br>kg |                           |                           |                  |                              |              |
| A3X5EU  | 15,800                                  | 2,260,000                           | 2,800,000  | 480                        | 154,000                    | 270                       | 710                       | 0.6              | 3                            | 32.7         |
| A3X8EU  | 28,200                                  | 3,600,000                           | 4,520,000  | 540                        | 181,500                    | 280                       | 740                       | 0.8              | 3                            | 38.5         |
| A3X12EU | 44,000                                  | 5,400,000                           | 6,780,000  | 610                        | 204,000                    | 270                       | 730                       | 1.2              | 3                            | 48.0         |

<sup>1</sup> For emergency use only applications it is sometimes possible to exceed the above ratings. Please consult ACE for further details.

<sup>2</sup> Figures for oil recirculation systems on request.

<sup>3</sup> The effective weight range limits can be raised or lowered to special order.

## Air/Oil Tanks for industrial shock absorbers

**For high cycle rates and extreme temperatures  
with limited mounting space**

**Shock absorbers convert the introduced energy into heat. The more frequently a shock absorber is stressed per hour, the hotter the oil volume becomes over time. If the requirements placed on the impact frequency of a shock absorber are especially high the use of an air-oil tank is just the right thing.**

Thanks to the increased oil volume and the resulting heat dissipation, the upper limit of the possible hourly energy capacity of the shock absorber increases significantly.

Another characteristic of the air-oil tank is the opportunity for controlled piston return if no permanent return force through an integrated spring in the shock absorber is desired.

### Air/Oil Tanks AO

#### A01

Oil capacity 20 cm<sup>3</sup>

Material: Aluminium caps

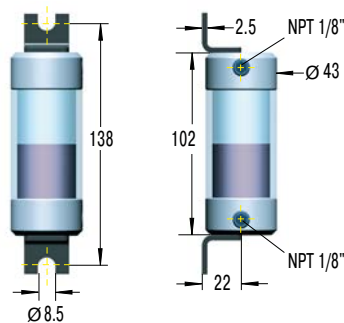

Detail drawings on request

#### A03

Oil capacity 370 cm<sup>3</sup>

Material: Steel

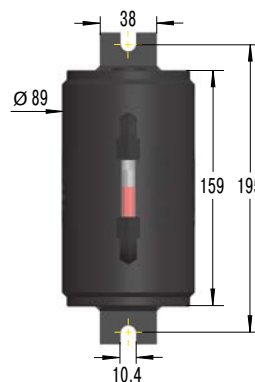

#### A06

Oil capacity 2,600 cm<sup>3</sup>

Material: Steel

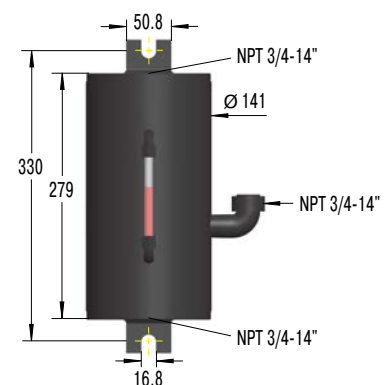

### Technical Data

**Operating pressure:** Max. 8 bar

**Operating temperature range:** 80 °C

**Damping medium:** ATF-Oil 42 cSt at 40 °C  
Mount air/oil tank higher than shock absorber.  
Bleed all air from system before operating.

**Safety instructions:** Exhaust tank before carrying out service. Check valve holds pressure!

**Suggested air/oil tanks in accordance with W<sub>4</sub> ratings**

### Connection Examples

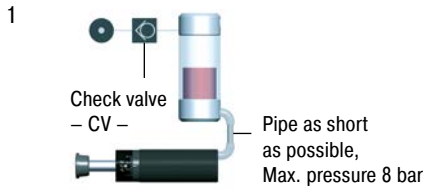

Piston rod returns immediately to extended position when load moves away. Operation without main air supply possible for short periods.

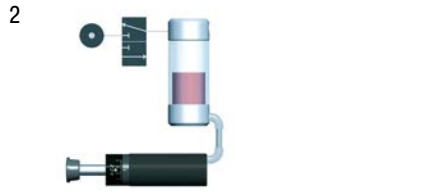

Return stroke may be sequenced by pneumatic valve at any desired time. No return force until valve energised.

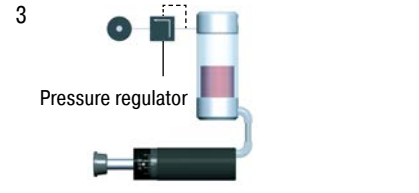

Return force can be adjusted by pressure regulator. Ensure safe minimum pressure to return shock absorber.



Spring return with air/oil tank. No air supply connected. Note: Will extend return time.

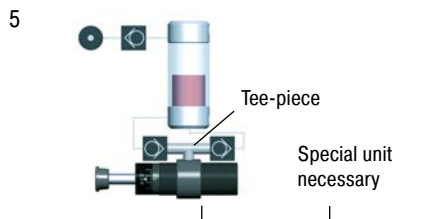

Oil recirculation circuit for extreme high cycle rates. Warm oil is positively circulated through air/oil tank for increased heat dissipation.

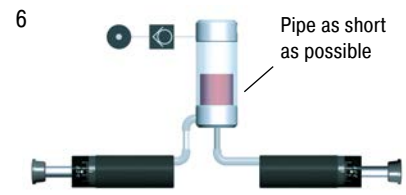

Connection of two shock absorbers to one air/oil tank is possible. Use next larger size tank. Combination with examples 2, 3 and 5 possible.

### Selection Chart Air/Oil Tanks

| Shock Absorber Type | With Tank Example 1 to 4 |             | With Recirc. Circuits Example 5 to 6 |             | Min. Conn. Pipe Ø<br>mm | Thread Sizes for Connection to Air/Oil Tank |                          |
|---------------------|--------------------------|-------------|--------------------------------------|-------------|-------------------------|---|--------------------------|
|                     | Tank                     | Check Valve | Tank                                 | Check Valve |                         | Thread Bottom                               | <sup>2</sup> Thread Side |
| MCA, MAA, MLA33...  | A01                      | CV1/8       | A03                                  | CV1/4       | 4                       | <sup>1</sup> 1/8-27 NPTF inside             | 1/8-27 NPTF inside       |
| MCA, MAA, MLA45...  | A01                      | CV1/8       | A03                                  | CV3/8       | 6                       | 1/8-27 NPTF inside                          | 1/8-27 NPTF inside       |
| MCA, MAA, MLA64...  | A03                      | CV1/4       | A06                                  | CV3/4       | 8                       | 1/4-18 NPTF inside                          | 1/4-18 NPTF inside       |
| CAA, AA2...         | A06                      | CV3/4       | A082                                 | CV3/4       | 15                      | -   | -                        |
| CAA, AA3...         | A06                      | CV3/4       | A082                                 | CV3/4       | 19                      | -   | -                        |
| CAA4...             | A082                     | CV3/4       | A082                                 | CV3/4       | 38                      | -   | -                        |

A082 and connection accessories: Details on request

<sup>1</sup> adapted

<sup>2</sup> on request (add suffix -PG/-P)

### Check Valves CV

Through an oil circuit fresh oil is drawn in from the industrial shock absorber and warm oil is pumped off (see example 5). To obtain this function, ACE offers suitable check valves of the CV series.

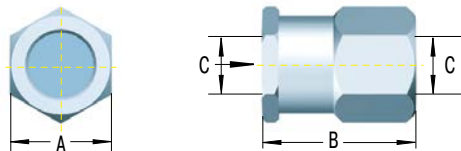

### Technical Data

**Operating pressure:** 20 bar

**Operating temperature range:** 95 °C

**Suitable for:** Oil, air, water

**Material:** Aluminium

### Check Valves – Dimensions

| TYPES | A<br>mm | B<br>mm | C          |
|-------|---------|---------|------------|
| CV1/8 | 19      | 24      | 1/8-27 NPT |
| CV1/4 | 29      | 33      | 1/4-18 NPT |
| CV3/8 | 29      | 33      | 3/8-18 NPT |
| CV1/2 | 41      | 40      | 1/2-14 NPT |
| CV3/4 | 48      | 59      | 3/4-14 NPT |



# Pallet Stoppers

## Control the flow of mass goods

**ACE offers a wide range of products for the most varied requirements in transfer technology – known as pallet stoppers or separators. These allow work-piece carriers with masses from 0.25 kg up to 1,200 kg to be separated from one another and forwarded individually. Further products such as positioning units or non-return devices and an extensive range of accessories are available on request.**



Pallet stoppers are used between individual processing stations within transport systems. Most objects transported on small pallets are halted at the processing stations or separated from a convoy.

Our compact machine elements operate pneumatically or electrically, with damping provided pneumatically or via integrated ACE shock absorbers. The pneumatic versions offer a choice between single-acting and double-acting separators that function either with or without inductive or electronic monitoring. The electric versions all provide shock-free operation in environments without compressed air.



## Transfer Technology Components

### Greatest process reliability and cycle stability

ACE pallet stoppers ensure gentle, precise and accurate damping of pallets and workpiece carriers on belt and roller conveyor systems and accumulating roller conveyors. This leaves transported goods and machinery unharmed and optimises process engineering. The high product quality increases speed along with improved longevity and reliability.

Our complete range of pallet stoppers combined with comprehensive accessories guarantees the greatest possible flexibility and maximum compatibility with a multitude of standard transfer systems.

High product quality

Cost-effective, sturdy solutions

Wide selection, even independent of compressed air

Suitable for high speeds

Space-saving and easy to install



More information about pallet stoppers can be found on our Website [www.ace-ace.com](http://www.ace-ace.com)

# Pneumatic Pallet Stoppers

## Gentle deceleration of light to heavy loads

The pneumatic ACE separators are divided into seven product families that cover mass ranges from 1 kg to 1,200 kg. A distinction is made in the case of attenuated products between monitoring options and between single-acting and double-acting models.

Speed and precise working are the top priority in production. ACE pallet stoppers are the ideal aids whenever workpieces have to be manoeuvred quickly and gently through production. This is because they provide shock-free deceleration of workpiece carriers, bring them to a pinpoint standstill and use pneumatic lowering to release them again to the next processing station after a freely definable waiting time – jointly or individually. Pneumatic damping force can be continuously adapted to the weight of the workpiece carrier.



### P-P60

**Our smallest: stops masses between 1 kg and 60 kg**

These are the smallest of the pneumatically-operated damping modules offered by ACE and they reliably stop masses from 1 kg up to 60 kg. They are used whilst manoeuvring sensitive products on transfer systems.

**Strong, precise,  
self-compensating or  
adjustable**

### P-H1200

**The largest: gentle and precise with an ACE shock absorber.**

**For heavy workpiece carriers up to 1.2 tons!**

Pure performance. Our largest pneumatic pallet stopper with integrated ACE shock absorber decelerates even high masses of 40 kg to 1,200 kg extremely effectively. Ideal for transferring sensitive products with significant weight.

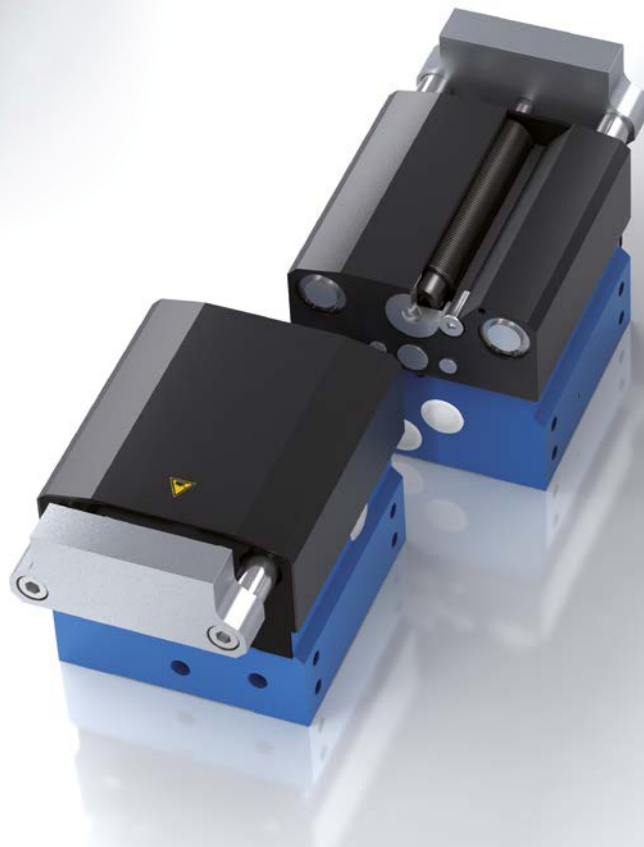

## Electric Pallet Stoppers

Perfect for safe and quiet operation

ACE electrically controlled separators come in four product families and cover a mass range from 0.25 kg up to 600 kg. The fact that these separators can manage without compressed air results in numerous benefits.

The positive aspects include less noise, greater environmental protection and higher efficiency. Electric models also work intelligently due to their sophisticated technology because they are self-compensating within larger weight ranges. The individual models are available with a 2x5-pin M12x1 connector, which can be attached to separators and cabled to a PLC. All in all, this provides a very convenient solution thanks to a reduced requirement for maintenance.

Quiet, without compressed air, simple installation



### P-E600

**Impressive: with an integrated ACE shock absorber for maximum accumulated loads up to 600 kg**

These electrically-operated ACE modules reliably stop even large masses, among other things using the built-in ACE shock absorber. A guarantee for quiet and safe operation.



### P-E20

**Small and delicate – for accumulated loads from 0.25 kg up to 20 kg**

These are the smallest, electrically-operated damping modules offered by ACE and are optimised for stopping lighter masses. They are used for the transfer of sensitive products at high speeds.

## Profile Dampers

### The low cost alternative for continuous duty

The exceedingly successful TUBUS series from ACE is a perfect alternative, when masses don't need to be decelerated to an exact point. Available in more than 140 different versions, the profile dampers are used to slow down masses, particularly under extreme conditions.

They are also recommended for use if there is little installation space available. Manufactured in co-polyester elastomer, the highly resistant absorbers provide the best benefits in areas where other materials fail or where a similarly high service life of up to 1 million load changes cannot be achieved. They are affordable, compact and light and absorb the energy with different damping characteristics depending on the design.

Very good price/performance ratio

Reliable in extreme situations

Highly resistant material

Compact and lightweight design

Easy to mount

Long service life



## Physical Properties of TUBUS Profile Dampers

**ACE TUBUS profile dampers** are high performance damping elements made from a special Co-Polyester Elastomer. They have a high energy absorbing capacity compared with other materials.

The excellent damping characteristics are achieved as a result of the special elastomer material and the worldwide unique construction design. This enables us to change the characteristics of the elastomer material so that individual and distinct damping curves are possible.

TUBUS dampers offer a considerable performance advantage when compared to other materials such as rubber, urethanes (PUR) and steel springs.

**A further advantage compared to other damping elements is the operating life expectancy – up to twenty times longer than with urethane dampers, up to ten times longer than with rubber dampers and up to five times longer than with steel spring dampers.**

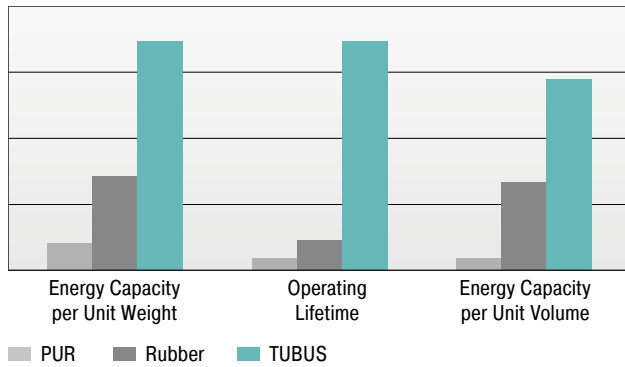

## Comparison of Damping Characteristics

The innovative TUBUS dampers absorb energy while exhibiting the following damping characteristics:

### Product family TA

Degressive characteristic with max. energy absorption with min. stroke.

Energy absorption: 58 % to 73 %

### Product family TS

Almost linear characteristic with low reaction force over a short operating stroke.

Energy absorption: 35 % to 64 %

### Product family TR/TR-L/TR-H

Progressive characteristic with gradually increasing reaction force over a long stroke.

Energy absorption TR: 25 % to 45 %

Energy absorption TR-L: 26 % to 41 %

Energy absorption TR-H: 39 % to 62 %

### Product family TR-HD

Progressive characteristic with high energy absorption with a short stroke.

Energy absorption: 43 % to 72 %

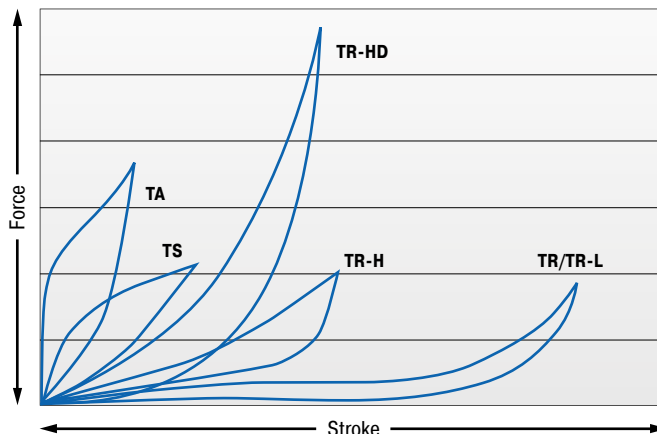

Characteristics of dynamic energy absorption for impact velocity over 0.5 m/s.

or impact velocities under 0.5 m/s, please request a static characteristic curve.



**TUBUS TA, TS, TR, TR-H, TR-HD**

| TYPES     | Max. Energy Capacity                    |  | Stroke max.<br>mm | Page |
|-----------|---|--|-------------------|------|
|           | <sup>1</sup> W <sub>3</sub><br>Nm/cycle | Emergency Stop<br>W <sub>3</sub><br>Nm/cycle |                   |      |
| TA12-5    | 2.0                                     | 3  | 5                 | 101  |
| TA17-7    | 6.0                                     | 9  | 7                 | 101  |
| TA21-9    | 10.0                                    | 16   | 9                 | 101  |
| TA22-10   | 11.5                                    | 21   | 10                | 101  |
| TA28-12   | 29.0                                    | 46   | 12                | 101  |
| TA34-14   | 48.0                                    | 87   | 14                | 101  |
| TA37-16   | 65.0                                    | 112  | 16                | 101  |
| TA40-16   | 82.0                                    | 130  | 16                | 101  |
| TA43-18   | 112.0                                   | 165  | 18                | 101  |
| TA47-20   | 140.0                                   | 173  | 20                | 101  |
| TA50-22   | 170.0                                   | 223  | 22                | 101  |
| TA54-22   | 201.0                                   | 334  | 22                | 101  |
| TA57-24   | 242.0                                   | 302  | 24                | 101  |
| TA62-25   | 304.0                                   | 361  | 25                | 101  |
| TA65-27   | 374.0                                   | 468  | 27                | 101  |
| TA70-29   | 421.0                                   | 524  | 29                | 101  |
| TA72-31   | 482.0                                   | 559  | 31                | 101  |
| TA80-32   | 570.0                                   | 831  | 32                | 101  |
| TA82-35   | 683.0                                   | 921  | 35                | 101  |
| TA85-36   | 797.0                                   | 1,043  | 36                | 101  |
| TA90-38   | 934.0                                   | 1,249  | 38                | 101  |
| TA98-40   | 1,147.0                                 | 1,555  | 40                | 101  |
| TA116-48  | 2,014.0                                 | 2,951  | 48                | 101  |
| TS14-7    | 2.0                                     | 3  | 7                 | 103  |
| TS18-9    | 4.0                                     | 6  | 9                 | 103  |
| TS20-10   | 6.0                                     | 7  | 10                | 103  |
| TS26-15   | 11.5                                    | 15   | 15                | 103  |
| TS32-16   | 23.0                                    | 26   | 16                | 103  |
| TS35-19   | 30.0                                    | 36   | 19                | 103  |
| TS40-19   | 34.0                                    | 42   | 19                | 103  |
| TS41-21   | 48.0                                    | 63   | 21                | 103  |
| TS44-23   | 63.0                                    | 72   | 23                | 103  |
| TS48-25   | 81.0                                    | 91   | 25                | 103  |
| TS51-27   | 92.0                                    | 114  | 27                | 103  |
| TS54-29   | 122.0                                   | 158  | 29                | 103  |
| TS58-30   | 149.0                                   | 154  | 30                | 103  |
| TS61-32   | 163.0                                   | 169  | 32                | 103  |
| TS64-34   | 208.0                                   | 254  | 34                | 103  |
| TS68-36   | 227.0                                   | 272  | 36                | 103  |
| TS75-39   | 291.0                                   | 408  | 39                | 103  |
| TS78-40   | 352.0                                   | 459  | 40                | 103  |
| TS82-44   | 419.0                                   | 620  | 44                | 103  |
| TS84-43   | 475.0                                   | 635  | 43                | 103  |
| TS90-47   | 580.0                                   | 778  | 47                | 103  |
| TS107-56  | 902.0                                   | 966  | 56                | 103  |
| TR29-17   | 1.2                                     | 1.8  | 17                | 105  |
| TR37-22   | 2.3                                     | 5.4  | 22                | 105  |
| TR43-25   | 3.5                                     | 8.1  | 25                | 105  |
| TR50-35   | 5.8                                     | 8.3  | 35                | 105  |
| TR63-43   | 12.0                                    | 17.0   | 43                | 105  |
| TR67-40   | 23.0                                    | 33.0   | 40                | 105  |
| TR76-46   | 34.5                                    | 43.0   | 46                | 105  |
| TR83-50   | 45.0                                    | 74.0   | 50                | 105  |
| TR85-50   | 68.0                                    | 92.0   | 50                | 105  |
| TR93-57   | 92.0                                    | 122.0  | 57                | 105  |
| TR100-60  | 115.0                                   | 146.0  | 60                | 105  |
| TR30-15H  | 2.7                                     | 5.7  | 15                | 107  |
| TR39-19H  | 6.0                                     | 18.0   | 19                | 107  |
| TR45-23H  | 8.7                                     | 24.0   | 23                | 107  |
| TR52-32H  | 11.7                                    | 20.0   | 32                | 107  |
| TR64-41H  | 25.0                                    | 46.0   | 41                | 107  |
| TR68-37H  | 66.5                                    | 98.0   | 37                | 107  |
| TR79-42H  | 81.5                                    | 106.0  | 42                | 107  |
| TR86-45H  | 124.0                                   | 206.0  | 45                | 107  |
| TR87-46H  | 158.0                                   | 261.0  | 46                | 107  |
| TR95-50H  | 228.0                                   | 342.0  | 50                | 107  |
| TR102-56H | 290.0                                   | 427.0  | 56                | 107  |
| TR42-14HD | 405                                     | 567  | 14                | 111  |
| TR47-12HD | 857                                     | 1,200  | 12                | 111  |
| TR47-17HD | 850                                     | 1,190  | 17                | 111  |
| TR52-14HD | 1,634                                   | 2,288  | 14                | 111  |
| TR57-21HD | 1,194                                   | 1,672  | 21                | 111  |

**TUBUS TA, TS, TR, TR-H, TR-HD**

| TYPES      | Max. Energy Capacity                    |  | Stroke max.<br>mm | Page |
|------------|---|--|-------------------|------|
|            | <sup>1</sup> W <sub>3</sub><br>Nm/cycle | Emergency Stop<br>W <sub>3</sub><br>Nm/cycle |                   |      |
| TR62-15HD  | 2,940                                   | 4,116  | 15                | 111  |
| TR62-19HD  | 2,940                                   | 4,116  | 19                | 111  |
| TR63-24HD  | 2,061                                   | 2,885  | 24                | 111  |
| TR72-26HD  | 1,700                                   | 2,380  | 26                | 111  |
| TR79-20HD  | 2,794                                   | 3,912  | 20                | 111  |
| TR79-31HD  | 2,975                                   | 4,165  | 31                | 111  |
| TR85-33HD  | 2,526                                   | 3,536  | 33                | 111  |
| TR89-21HD  | 4,438                                   | 6,213  | 21                | 111  |
| TR90-37HD  | 3,780                                   | 5,292  | 37                | 111  |
| TR93-24HD  | 3,421                                   | 4,789  | 24                | 111  |
| TR97-31HD  | 7,738                                   | 10,833                                       | 31                | 111  |
| TR97-35HD  | 2,821                                   | 3,949  | 35                | 111  |
| TR102-44HD | 4,697                                   | 6,576  | 44                | 111  |
| TR105-28HD | 5,641                                   | 7,897  | 28                | 111  |
| TR117-30HD | 8,457                                   | 11,840                                       | 30                | 111  |

<sup>1</sup> Max. energy capacity per cycle for continuous use.

**TUBUS TR-L**

| TYPES        | Max. Energy Capacity                    |  | Stroke max.<br>mm | Page |
|--------------|---|--|-------------------|------|
|              | <sup>1</sup> W <sub>3</sub><br>Nm/cycle | Emergency Stop<br>W <sub>3</sub><br>Nm/cycle |                   |      |
| TR29-17L     | 7.2                                     | 10.9   | 17                | 109  |
| TR43-25L     | 14.0                                    | 32.7   | 25                | 109  |
| TR63-43L     | 21.9                                    | 32.0   | 43                | 109  |
| TR66-40L-1   | 102.0                                   | 143.0  | 40                | 109  |
| TR66-40L-2   | 204.0                                   | 286.0  | 40                | 109  |
| TR66-40L-3   | 306.0                                   | 428.0  | 40                | 109  |
| TR66-40L-4   | 408.0                                   | 571.0  | 40                | 109  |
| TR66-40L-5   | 510.0                                   | 714.0  | 40                | 109  |
| TR76-45L-1   | 145.0                                   | 203.0  | 45                | 109  |
| TR76-45L-2   | 290.0                                   | 406.0  | 45                | 109  |
| TR76-45L-3   | 435.0                                   | 609.0  | 45                | 109  |
| TR76-45L-4   | 580.0                                   | 812.0  | 45                | 109  |
| TR76-45L-5   | 725.0                                   | 1,015.0                                      | 45                | 109  |
| TR83-48L-1   | 180.0                                   | 252.0  | 48                | 109  |
| TR83-48L-2   | 360.0                                   | 504.0  | 48                | 109  |
| TR83-48L-3   | 540.0                                   | 756.0  | 48                | 109  |
| TR83-48L-4   | 720.0                                   | 1,008.0                                      | 48                | 109  |
| TR83-48L-5   | 900.0                                   | 1,260.0                                      | 48                | 109  |
| TR99-60L-1   | 270.0                                   | 378.0  | 60                | 109  |
| TR99-60L-2   | 540.0                                   | 756.0  | 60                | 109  |
| TR99-60L-3   | 810.0                                   | 1,134.0                                      | 60                | 109  |
| TR99-60L-4   | 1,080.0                                 | 1,512.0                                      | 60                | 109  |
| TR99-60L-5   | 1,350.0                                 | 1,890.0                                      | 60                | 109  |
| TR99-60L-6   | 1,620.0                                 | 2,268.0                                      | 60                | 109  |
| TR99-60L-7   | 1,890.0                                 | 2,646.0                                      | 60                | 109  |
| TR143-86L-1  | 600.0                                   | 840.0  | 86                | 109  |
| TR143-86L-2  | 1,200.0                                 | 1,680.0                                      | 86                | 109  |
| TR143-86L-3  | 1,800.0                                 | 2,520.0                                      | 86                | 109  |
| TR143-86L-4  | 2,400.0                                 | 3,360.0                                      | 86                | 109  |
| TR143-86L-5  | 3,000.0                                 | 4,200.0                                      | 86                | 109  |
| TR143-86L-6  | 3,600.0                                 | 5,040.0                                      | 86                | 109  |
| TR143-86L-7  | 4,200.0                                 | 5,880.0                                      | 86                | 109  |
| TR188-108L-1 | 1,100.0                                 | 1,540.0                                      | 108               | 109  |
| TR188-108L-2 | 2,200.0                                 | 3,080.0                                      | 108               | 109  |
| TR188-108L-3 | 3,300.0                                 | 4,620.0                                      | 108               | 109  |
| TR188-108L-4 | 4,400.0                                 | 6,160.0                                      | 108               | 109  |
| TR188-108L-5 | 5,500.0                                 | 7,700.0                                      | 108               | 109  |
| TR188-108L-6 | 6,600.0                                 | 9,240.0                                      | 108               | 109  |
| TR188-108L-7 | 7,700.0                                 | 10,780.0                                     | 108               | 109  |

<sup>1</sup> Max. energy capacity per cycle for continuous use.

## Profile Dampers



### TUBUS TA

Page 100

Axial Damping

**Compact size and strong force absorption**

Linear slides, Pneumatic cylinders, Handling modules, Machines and plants



### TUBUS TS

Page 102

Axial Soft Damping

**Compact size and smooth deceleration**

Linear slides, Pneumatic cylinders, Handling modules, Machines and plants



### TUBUS TR

Page 104

Radial Damping

**Compact size and soft deceleration**

Furniture industry, Sports equipment, Linear slides, Pneumatic cylinders



### TUBUS TR-H

Page 106

Radial Damping, Hard Version

**Compact size with soft deceleration and high energy absorption**

Furniture industry, Sports equipment, Linear slides, Pneumatic cylinders



### TUBUS TR-L

Page 108

Radial Damping, Long Version

**Powerhouse in long body length**

Offshore industry, Agricultural machinery, Impact panels, Conveyor systems



### TUBUS TR-HD

Page 110

Radial Damping, Heavy Duty Version

**Compact powerhouse in solid material**

Offshore industry, Agricultural machinery, Impact panels, Conveyor systems

# TUBUS TA

## Compact size and strong force absorption

### Axial Damping

**Energy capacity 2 Nm/Cycle to 2,951 Nm/Cycle**

**Maximum stroke 5 mm bis 48 mm**

Very efficient energy guzzlers: The TA profile dampers from the ACE TUBUS-Series are maintenance-free and ready to install. They consist of co-polyester elastomer; a material that only heats up slightly and ensures consistent damping. The TA models absorb a lot of energy at the start of the stroke.

The TA family has been specially developed for maximum energy absorption within a range of 2 Nm to 2,951 Nm. The minimum height is thanks to the space-saving shape with  $\varnothing$  12 mm to  $\varnothing$  116 mm. The dampers can be very easily and quickly fixed with the provided special screw.

These compact, cost-effective machine elements are ideal as end position dampers in linear axes, in toolmaking and tool machines, in hydraulic and pneumatic equipment, handling equipment and other applications.



### Technical Data

**Energy capacity:** 2 Nm/Cycle to 2,951 Nm/Cycle

**Energy absorption:** 58 % to 73 %

**Dynamic force range:** 870 N to 90,000 N

**Operating temperature range:** -40 °C to +90 °C

**Construction size:** 12 mm to 116 mm

**Mounting:** In any position

**Material hardness rating:** Shore 55D

**Material:** Profile body: Co-Polyester Elastomer

**Environment:** Resistant to microbes, seawater or chemical attack. Excellent UV and

ozone resistance. Material does not absorb water or swell.

**Impact velocity range:** Max. 5 m/s

**Torque max.:**

M3: 1 Nm

M4: 1.7 Nm

M5: 2.3 Nm

M6: 6 Nm

M8: 20 Nm

M12: 50 Nm

M16: 120 Nm

**Application field:** Linear slides, Pneumatic cylinders, Handling modules, Machines and plants, Swivel units, Electro-mechanical

drives, Hydraulic devices, Conveyor systems, Crane systems

**Note:** Suitable for emergency stop applications and for continuous use. For applications with preloading and increased temperatures please consult ACE.

**Safety instructions:** Mounting screw should additionally be secured with Loctite.

**On request:** Special strokes, -characteristics, -spring rates, -sizes and -materials.

### TA

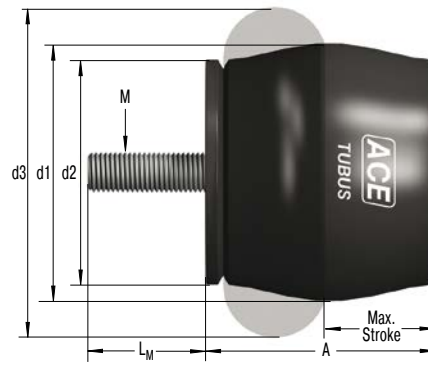

### Characteristics

**Type TA37-16**  
**Energy-Stroke Characteristic (dynamic)**  
 (with impact velocity over 0.5 m/s)

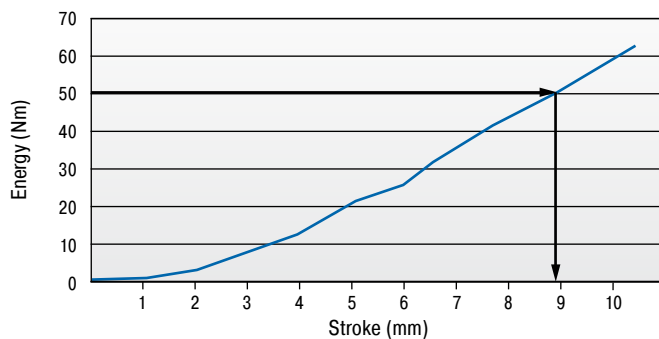

**Type TA37-16**  
**Force-Stroke Characteristic (dynamic)**  
 (with impact velocity over 0.5 m/s)

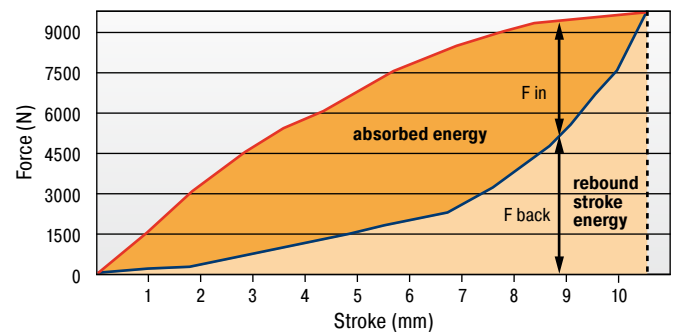

With the aid of the characteristic curves above you can estimate the proportion of the total energy that will be absorbed.  
 Example: With impact energy of 50 Nm the Energy-Stroke diagram shows that a stroke of about 8.8 mm is needed.  
 On the Force-Stroke diagram you can estimate the proportion of absorbed energy to rebound energy at this stroke length.  
**Dynamic ( $v > 0.5$  m/s) and static ( $v \leq 0.5$  m/s) characteristics of all types are available on request.**

**The calculation and selection of the most suitable damper should be carried out or be approved by ACE.**

#### Ordering Example

TUBUS Axial \_\_\_\_\_ **TA37-16**  
 Outer-Ø 37 mm \_\_\_\_\_  
 Stroke 16 mm \_\_\_\_\_

### Performance and Dimensions

| TYPES    | Emergency Stop                          |                            | Stroke max.<br>mm | A<br>mm | d1<br>mm | d2<br>mm | d3<br>mm | L <sub>M</sub><br>mm | M   | Weight<br>kg |
|----------|---|----------------------------|-------------------|---------|----------|----------|----------|----------------------|-----|--------------|
|          | <sup>1</sup> W <sub>3</sub><br>Nm/cycle | W <sub>3</sub><br>Nm/cycle |                   |         |          |          |          |                      |     |              |
| TA12-5   | 2.0                                     | 3                          | 5                 | 11      | 12       | 11       | 15       | 3                    | M3  | 0.001        |
| TA17-7   | 6.0                                     | 9                          | 7                 | 16      | 17       | 15       | 22       | 4                    | M4  | 0.004        |
| TA21-9   | 10.0                                    | 16                         | 9                 | 18      | 21       | 18       | 26       | 5                    | M5  | 0.007        |
| TA22-10  | 11.5                                    | 21                         | 10                | 19      | 22       | 19       | 27       | 6                    | M6  | 0.008        |
| TA28-12  | 29.0                                    | 46                         | 12                | 26      | 28       | 25       | 36       | 6                    | M6  | 0.016        |
| TA34-14  | 48.0                                    | 87                         | 14                | 30      | 34       | 30       | 43       | 6                    | M6  | 0.024        |
| TA37-16  | 65.0                                    | 112                        | 16                | 33      | 37       | 33       | 48       | 6                    | M6  | 0.030        |
| TA40-16  | 82.0                                    | 130                        | 16                | 35      | 40       | 34       | 50       | 8                    | M8  | 0.040        |
| TA43-18  | 112.0                                   | 165                        | 18                | 38      | 43       | 38       | 55       | 8                    | M8  | 0.051        |
| TA47-20  | 140.0                                   | 173                        | 20                | 41      | 47       | 41       | 60       | 12                   | M12 | 0.070        |
| TA50-22  | 170.0                                   | 223                        | 22                | 45      | 50       | 44       | 64       | 12                   | M12 | 0.085        |
| TA54-22  | 201.0                                   | 334                        | 22                | 47      | 54       | 47       | 68       | 12                   | M12 | 0.100        |
| TA57-24  | 242.0                                   | 302                        | 24                | 51      | 57       | 50       | 73       | 12                   | M12 | 0.116        |
| TA62-25  | 304.0                                   | 361                        | 25                | 54      | 62       | 53       | 78       | 12                   | M12 | 0.132        |
| TA65-27  | 374.0                                   | 468                        | 27                | 58      | 65       | 57       | 82       | 12                   | M12 | 0.153        |
| TA70-29  | 421.0                                   | 524                        | 29                | 61      | 70       | 60       | 86       | 12                   | M12 | 0.174        |
| TA72-31  | 482.0                                   | 559                        | 31                | 65      | 72       | 63       | 91       | 16                   | M16 | 0.257        |
| TA80-32  | 570.0                                   | 831                        | 32                | 69      | 80       | 69       | 100      | 16                   | M16 | 0.311        |
| TA82-35  | 683.0                                   | 921                        | 35                | 74      | 82       | 72       | 105      | 16                   | M16 | 0.350        |
| TA85-36  | 797.0                                   | 1,043                      | 36                | 76      | 85       | 75       | 110      | 16                   | M16 | 0.391        |
| TA90-38  | 934.0                                   | 1,249                      | 38                | 80      | 90       | 78       | 114      | 16                   | M16 | 0.414        |
| TA98-40  | 1,147.0                                 | 1,555                      | 40                | 86      | 98       | 85       | 123      | 16                   | M16 | 0.513        |
| TA116-48 | 2,014.0                                 | 2,951                      | 48                | 101     | 116      | 98       | 146      | 16                   | M16 | 0.803        |

<sup>1</sup> Max. energy capacity per cycle for continuous use.

# TUBUS TS

## Compact size and smooth deceleration

### Axial Soft Damping

**Energy capacity 2 Nm/Cycle to 966 Nm/Cycle**

**Maximum stroke 7 mm to 56 mm**

Energy absorption in a compact and uniform way: The TS (TUBUS soft) profile dampers are also manufactured from co-polyester elastomer. Due to the almost linear damping characteristic curve, the maintenance-free, ready-to-install components softly absorb the energy with minimum strain on the machine. Consistent damping is helped by the low temperature increase of the material during operation.

The TS-Series impresses with maximum energy absorption within a range of 2 Nm to 966 Nm within a minimum height. The space-saving design has been implemented from Ø 14 mm to Ø 107 mm. The special screw supplied is used to simply and quickly fix the profile dampers in place.

Suitable for emergency stop and permanent applications, the cost-effective, durable TUBUS TS can be used as end position dampers in linear axes, in toolmaking and tool machines and in hydraulic, pneumatic and handling equipment.



### Technical Data

**Energy capacity:** 2 Nm/Cycle to 966 Nm/Cycle

**Energy absorption:** 35 % to 64 %

**Dynamic force range:** 533 N to 23,500 N

**Operating temperature range:** -40 °C to +90 °C

**Construction size:** 14 mm to 107 mm

**Mounting:** In any position

**Material hardness rating:** Shore 40D

**Material:** Profile body: Co-Polyester Elastomer

**Environment:** Resistant to microbes, seawater or chemical attack. Excellent UV and

ozone resistance. Material does not absorb water or swell.

**Impact velocity range:** Max. 5 m/s

**Torque max.:**

M4: 1.7 Nm

M5: 2.3 Nm

M6: 6 Nm

M12: 50 Nm

M16: 120 Nm

**Application field:** Linear slides, Pneumatic cylinders, Handling modules, Machines and plants, Swivel units, Electro-mechanical drives, Crane systems, Conveyor systems, Crane systems

**Note:** Suitable for emergency stop applications and for continuous use. For applications with preloading and increased temperatures please consult ACE.

**Safety instructions:** Mounting screw should additionally be secured with Loctite.

**On request:** Special strokes, -characteristics, -spring rates, -sizes and -materials.

### TS

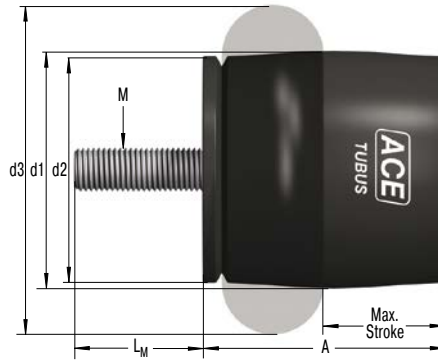

### Characteristics

**Type TS44-23**  
**Energy-Stroke Characteristic (dynamic)**  
 (with impact velocity over 0.5 m/s)

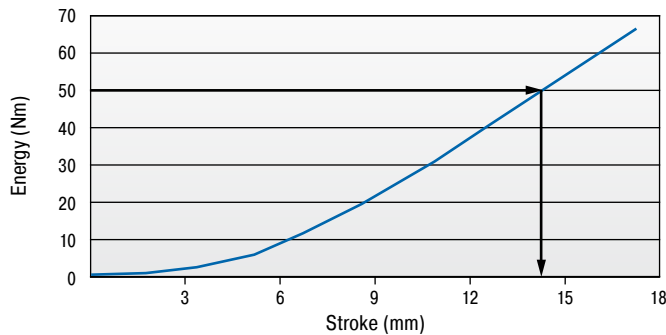

**Type TS44-23**  
**Force-Stroke Characteristic (dynamic)**  
 (with impact velocity over 0.5 m/s)

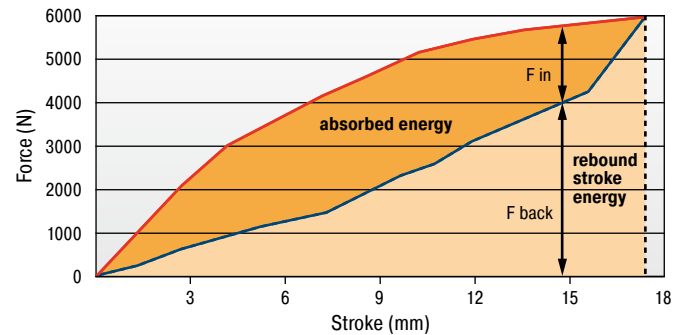

With the aid of the characteristic curves above you can estimate the proportion of the total energy that will be absorbed.  
 Example: With impact energy of 50 Nm the Energy-Stroke diagram shows that a stroke of about 14 mm is needed.  
 On the Force-Stroke diagram you can estimate the proportion of absorbed energy to rebound energy at this stroke length.  
**Dynamic ( $v > 0.5$  m/s) and static ( $v \leq 0.5$  m/s) characteristics of all types are available on request.**

**The calculation and selection of the most suitable damper should be carried out or be approved by ACE.**

#### Ordering Example

TUBUS Axial Soft \_\_\_\_\_ **TS44-23**  
 Outer-Ø 44 mm \_\_\_\_\_  
 Stroke 23 mm \_\_\_\_\_

### Performance and Dimensions

| TYPES    | Emergency Stop                          |                            | Stroke max.<br>mm | A<br>mm | d1<br>mm | d2<br>mm | d3<br>mm | L <sub>M</sub><br>mm | M   | Weight<br>kg |
|----------|---|----------------------------|-------------------|---------|----------|----------|----------|----------------------|-----|--------------|
|          | <sup>1</sup> W <sub>3</sub><br>Nm/cycle | W <sub>3</sub><br>Nm/cycle |                   |         |          |          |          |                      |     |              |
| TS14-7   | 2.0                                     | 3                          | 7                 | 15      | 14       | 13       | 19       | 4                    | M4  | 0.003        |
| TS18-9   | 4.0                                     | 6                          | 9                 | 18      | 18       | 16       | 24       | 5                    | M5  | 0.006        |
| TS20-10  | 6.0                                     | 7                          | 10                | 21      | 20       | 19       | 27       | 6                    | M6  | 0.009        |
| TS26-15  | 11.5                                    | 15                         | 15                | 28      | 26       | 25       | 37       | 6                    | M6  | 0.016        |
| TS32-16  | 23.0                                    | 26                         | 16                | 32      | 32       | 30       | 44       | 6                    | M6  | 0.021        |
| TS35-19  | 30.0                                    | 36                         | 19                | 36      | 35       | 33       | 48       | 6                    | M6  | 0.028        |
| TS40-19  | 34.0                                    | 42                         | 19                | 38      | 40       | 34       | 51       | 6                    | M6  | 0.031        |
| TS41-21  | 48.0                                    | 63                         | 21                | 41      | 41       | 38       | 55       | 12                   | M12 | 0.060        |
| TS44-23  | 63.0                                    | 72                         | 23                | 45      | 44       | 40       | 60       | 12                   | M12 | 0.070        |
| TS48-25  | 81.0                                    | 91                         | 25                | 49      | 48       | 44       | 64       | 12                   | M12 | 0.080        |
| TS51-27  | 92.0                                    | 114                        | 27                | 52      | 51       | 47       | 69       | 12                   | M12 | 0.095        |
| TS54-29  | 122.0                                   | 158                        | 29                | 55      | 54       | 50       | 73       | 12                   | M12 | 0.105        |
| TS58-30  | 149.0                                   | 154                        | 30                | 59      | 58       | 53       | 78       | 12                   | M12 | 0.132        |
| TS61-32  | 163.0                                   | 169                        | 32                | 62      | 61       | 56       | 83       | 16                   | M16 | 0.203        |
| TS64-34  | 208.0                                   | 254                        | 34                | 66      | 64       | 60       | 87       | 16                   | M16 | 0.232        |
| TS68-36  | 227.0                                   | 272                        | 36                | 69      | 68       | 63       | 92       | 16                   | M16 | 0.248        |
| TS75-39  | 291.0                                   | 408                        | 39                | 75      | 75       | 69       | 101      | 16                   | M16 | 0.301        |
| TS78-40  | 352.0                                   | 459                        | 40                | 79      | 78       | 72       | 105      | 16                   | M16 | 0.339        |
| TS82-44  | 419.0                                   | 620                        | 44                | 84      | 82       | 75       | 110      | 16                   | M16 | 0.346        |
| TS84-43  | 475.0                                   | 635                        | 43                | 85      | 84       | 78       | 115      | 16                   | M16 | 0.402        |
| TS90-47  | 580.0                                   | 778                        | 47                | 92      | 90       | 84       | 124      | 16                   | M16 | 0.490        |
| TS107-56 | 902.0                                   | 966                        | 56                | 110     | 107      | 100      | 147      | 16                   | M16 | 0.733        |

<sup>1</sup> Max. energy capacity per cycle for continuous use.



# TUBUS TR

## Compact size and soft deceleration

### Radial Damping

**Energy capacity 1.2 Nm/Cycle to 146 Nm/Cycle**

**Maximum stroke 17 mm bis 60 mm**

For long, soft braking action: The Radial damping forces in this model from the ACE TUBUS-Series provides the TR range. These maintenance-free, ready-to-install elements are made of co-polyester elastomer, which only heats up slightly during operation and therefore provides consistent damping.

The radial loading enables a very long and soft deceleration with progressive energy reduction at the end of the stroke. The TR-Series has been specially designed for maximum stroke with a minimum height, producing an energy absorption per stroke extending from 1.2 Nm to 146 Nm. The dampers are available in compact formats of Ø 29 mm to Ø 100 mm and are supplied with a special screw for simple, quick assembly.

The TUBUS TR products are suitable as end position dampers in linear axes, in toolmaking and tool machines, in hydraulic and pneumatic equipment, handling equipment and other applications.



### Technical Data

**Energy capacity:** 1.2 Nm/Cycle to 146 Nm/Cycle

**Energy absorption:** 25 % to 45 %

**Dynamic force range:** 218 N to 7,500 N

**Operating temperature range:** -40 °C to +90 °C

**Construction size:** 29 mm to 100 mm

**Mounting:** In any position

**Material hardness rating:** Shore 40D

**Material:** Profile body: Co-Polyester Elastomer

**Environment:** Resistant to microbes, seawater or chemical attack. Excellent UV and ozone resistance. Material does not absorb water or swell.

**Impact velocity range:** Max. 5 m/s

**Torque max.:**

M5: 3 Nm

M6: 6 Nm

M8: 20 Nm

**Application field:** Furniture industry, Sports equipment, Linear slides, Pneumatic cylinders, Handling modules, Machines and plants, Stacking units, Electro-mechanical drives, Conveyor systems

**Note:** Suitable for emergency stop applications and for continuous use. For applications with preloading and increased temperatures please consult ACE.

**Safety instructions:** Mounting screw should additionally be secured with Loctite.

**On request:** Special strokes, -characteristics, -spring rates, -sizes and -materials.

### TR

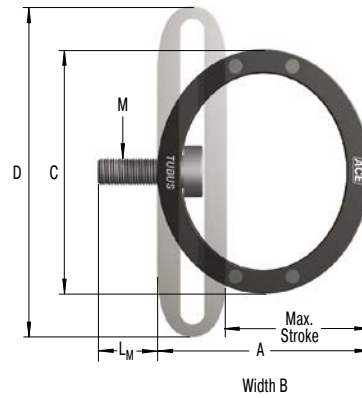

### Characteristics

#### Type TR93-57

**Energy-Stroke Characteristic (dynamic)**  
(with impact velocity over 0.5 m/s)

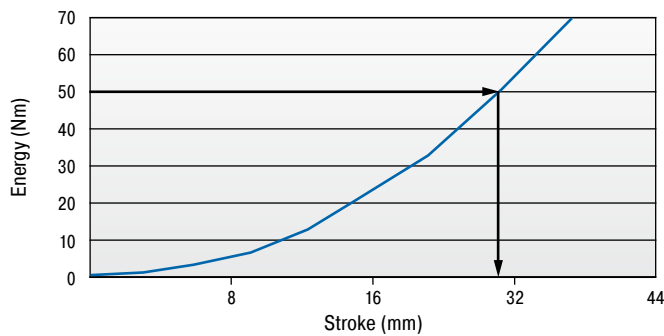

#### Type TR93-57

**Force-Stroke Characteristic (dynamic)**  
(with impact velocity over 0.5 m/s)

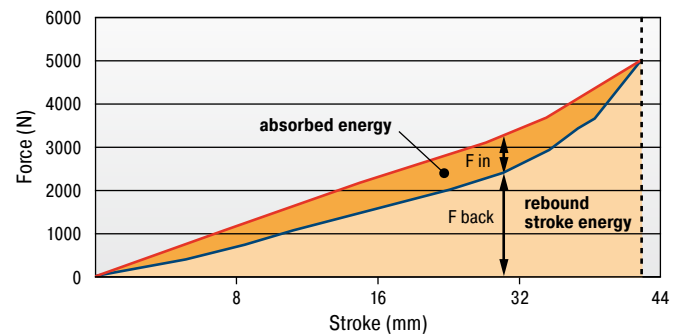

With the aid of the characteristic curves above you can estimate the proportion of the total energy that will be absorbed.  
Example: With impact energy of 50 Nm the Energy-Stroke diagram shows that a stroke of about 31 mm is needed.  
On the Force-Stroke diagram you can estimate the proportion of absorbed energy to rebound energy at this stroke length.  
**Dynamic ( $v > 0.5$  m/s) and static ( $v \leq 0.5$  m/s) characteristics of all types are available on request.**

The calculation and selection of the most suitable damper should be carried out or be approved by ACE.

#### Ordering Example

TUBUS Radial \_\_\_\_\_ **TR93-57**  
Outer-Ø 93 mm \_\_\_\_\_  
Stroke 57 mm \_\_\_\_\_

### Performance and Dimensions

| TYPES    | Emergency Stop                          |                            | Stroke max.<br>mm | A<br>mm | B<br>mm | C<br>mm | D<br>mm | L <sub>M</sub><br>mm | M  | Weight<br>kg |
|----------|---|----------------------------|-------------------|---------|---------|---------|---------|----------------------|----|--------------|
|          | <sup>1</sup> W <sub>s</sub><br>Nm/cycle | W <sub>s</sub><br>Nm/cycle |                   |         |         |         |         |                      |    |              |
| TR29-17  | 1.2                                     | 1.8                        | 17                | 25      | 13      | 29      | 38      | 5                    | M5 | 0.010        |
| TR37-22  | 2.3                                     | 5.4                        | 22                | 32      | 19      | 37      | 50      | 5                    | M5 | 0.013        |
| TR43-25  | 3.5                                     | 8.1                        | 25                | 37      | 20      | 43      | 58      | 5                    | M5 | 0.017        |
| TR50-35  | 5.8                                     | 8.3                        | 35                | 44      | 34      | 50      | 68      | 5                    | M5 | 0.025        |
| TR63-43  | 12.0                                    | 17.0                       | 43                | 55      | 43      | 63      | 87      | 5                    | M5 | 0.051        |
| TR67-40  | 23.0                                    | 33.0                       | 40                | 59      | 46      | 67      | 88      | 5                    | M5 | 0.089        |
| TR76-46  | 34.5                                    | 43.0                       | 46                | 67      | 46      | 76      | 102     | 6                    | M6 | 0.104        |
| TR83-50  | 45.0                                    | 74.0                       | 50                | 73      | 51      | 83      | 109     | 6                    | M6 | 0.142        |
| TR85-50  | 68.0                                    | 92.0                       | 50                | 73      | 68      | 85      | 111     | 8                    | M8 | 0.206        |
| TR93-57  | 92.0                                    | 122.0                      | 57                | 83      | 83      | 93      | 124     | 8                    | M8 | 0.297        |
| TR100-60 | 115.0                                   | 146.0                      | 60                | 88      | 82      | 100     | 133     | 8                    | M8 | 0.308        |

<sup>1</sup> Max. energy capacity per cycle for continuous use.

## TUBUS TR-H

Compact size with soft deceleration and high energy absorption

### Radial Damping, Hard Version

Energy capacity 2.7 Nm/Cycle to 427 Nm/Cycle

Maximum stroke 15 mm bis 56 mm

Harder mixture of materials for higher energy absorption: The maintenance-free and ready-to-install TR-H-Series profile dampers, are stressed radially in the same way as the basic TR model. With almost the same dimensions, they also decelerate with a very long and soft action. The harder co-polyester elastomer mixture leads to significantly high energy absorption of 2.7 Nm to 427 Nm in these models. Easy to mount due to the supplied special screw.

The TR-H-Series is space-saving with dimensions of Ø 30 mm to Ø 102 mm. It complements the TUBUS range between the progressive TR and almost linear TS models. Users are therefore provided with a full range of deceleration curves within the ACE TUBUS family.

The TUBUS TR-H products are suitable end position dampers in linear axes, in toolmaking and tool machines and in hydraulic, pneumatic and handling equipment as well as other applications.



### Technical Data

**Energy capacity:** 2.7 Nm/Cycle to 427 Nm/Cycle

**Energy absorption:** 39 % to 62 %

**Dynamic force range:** 550 N to 21,200 N

**Operating temperature range:** -40 °C to +90 °C

**Construction size:** 30 mm to 102 mm

**Mounting:** In any position

**Material hardness rating:** Shore 55D

**Material:** Profile body: Co-Polyester Elastomer

**Environment:** Resistant to microbes, seawater or chemical attack. Excellent UV and

ozone resistance. Material does not absorb water or swell.

**Impact velocity range:** Max. 5 m/s

**Torque max.:**

M5: 3 Nm

M6: 6 Nm

M8: 20 Nm

**Application field:** Furniture industry, Sports equipment, Linear slides, Pneumatic cylinders, Handling modules, Machines and plants, Stacking units, Electro-mechanical drives, Conveyor systems

**Note:** Suitable for emergency stop applications and for continuous use. For applications

with preloading and increased temperatures please consult ACE.

**Safety instructions:** Mounting screw should additionally be secured with Loctite.

**On request:** Special strokes, -characteristics, -spring rates, -sizes and -materials.

### TR-H

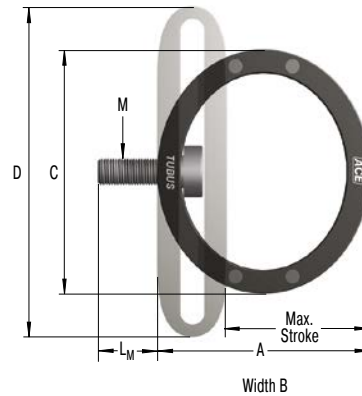

### Characteristics

#### Type TR95-50H

**Energy-Stroke Characteristic (dynamic)**  
(with impact velocity over 0.5 m/s)

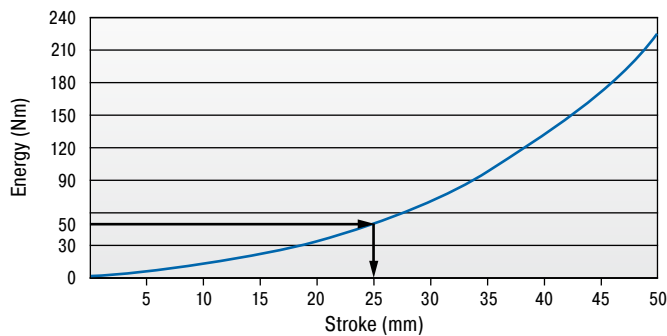

#### Type TR95-50H

**Force-Stroke Characteristic (dynamic)**  
(with impact velocity over 0.5 m/s)

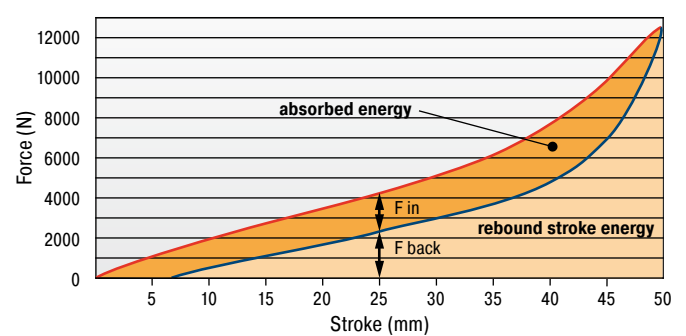

With the aid of the characteristic curves above you can estimate the proportion of the total energy that will be absorbed.  
Example: With impact energy of 50 Nm the Energy-Stroke diagram shows that a stroke of about 25 mm is needed.  
On the Force-Stroke diagram you can estimate the proportion of absorbed energy to rebound energy at this stroke length.  
**Dynamic ( $v > 0.5$  m/s) and static ( $v \leq 0.5$  m/s) characteristics of all types are available on request.**

The calculation and selection of the most suitable damper should be carried out or be approved by ACE.

#### Ordering Example

TUBUS Radial \_\_\_\_\_ ↑ ↑ ↑  
Outer-Ø 95 mm \_\_\_\_\_ ↑  
Stroke 50 mm \_\_\_\_\_ ↑  
Hard Version \_\_\_\_\_ ↑

**TR95-50H**

### Performance and Dimensions

| TYPES     | Emergency Stop                          |                            | Stroke max.<br>mm | A<br>mm | B<br>mm | C<br>mm | D<br>mm | L <sub>M</sub><br>mm | M  | Weight<br>kg |
|-----------|---|----------------------------|-------------------|---------|---------|---------|---------|----------------------|----|--------------|
|           | <sup>1</sup> W <sub>s</sub><br>Nm/cycle | W <sub>s</sub><br>Nm/cycle |                   |         |         |         |         |                      |    |              |
| TR30-15H  | 2.7                                     | 5.7                        | 15                | 23      | 13      | 30      | 38      | 5                    | M5 | 0.009        |
| TR39-19H  | 6.0                                     | 18.0                       | 19                | 30      | 19      | 39      | 50      | 5                    | M5 | 0.013        |
| TR45-23H  | 8.7                                     | 24.0                       | 23                | 36      | 20      | 45      | 58      | 5                    | M5 | 0.019        |
| TR52-32H  | 11.7                                    | 20.0                       | 32                | 42      | 34      | 52      | 68      | 5                    | M5 | 0.030        |
| TR64-41H  | 25.0                                    | 46.0                       | 41                | 53      | 43      | 64      | 87      | 5                    | M5 | 0.054        |
| TR68-37H  | 66.5                                    | 98.0                       | 37                | 56      | 46      | 68      | 88      | 5                    | M5 | 0.095        |
| TR79-42H  | 81.5                                    | 106.0                      | 42                | 64      | 46      | 79      | 102     | 6                    | M6 | 0.107        |
| TR86-45H  | 124.0                                   | 206.0                      | 45                | 69      | 51      | 86      | 109     | 6                    | M6 | 0.152        |
| TR87-46H  | 158.0                                   | 261.0                      | 46                | 68      | 67      | 86      | 111     | 8                    | M8 | 0.188        |
| TR95-50H  | 228.0                                   | 342.0                      | 50                | 77      | 82      | 95      | 124     | 8                    | M8 | 0.281        |
| TR102-56H | 290.0                                   | 427.0                      | 56                | 84      | 81      | 102     | 133     | 8                    | M8 | 0.334        |

<sup>1</sup> Max. energy capacity per cycle for continuous use.

# TUBUS TR-L

## Powerhouse in long body length

### Radial Damping, Long Version

**Energy capacity 7.2 Nm/Cycle to 10,780 Nm/Cycle**

**Maximum stroke 17 mm bis 108 mm**

Especially for applications with long and soft deceleration: The radial tube dampers TR-L from the ACE TUBUS-Series are maintenance-free, ready-to-install elements made of co-polyester elastomer.

Their radial load offers designers a very long and soft deceleration with a progressive reduction in energy at the end of the stroke. The TR-L-Series has been specially developed for a maximum stroke with a minimum height and a range of 7.2 Nm to 10,780 Nm. The absorption capacity is dependent on the length of the selected tube damper. These models are available in sizes between Ø 29 mm and Ø 188 mm.

The TUBUS TR-L is used where impact or collision protection is necessary along a straight line e.g. on shovels in mining equipment, loading and lifting devices, dock systems in shipbuilding or luggage and transport belts.



### Technical Data

**Energy capacity:** 7.2 Nm/Cycle to 10,780 Nm/Cycle

**Energy absorption:** 26 % to 41 %

**Dynamic force range:** 1,312 N to 217,700 N

**Operating temperature range:** -40 °C to +90 °C

**Construction size:** 29 mm to 188 mm

**Mounting:** In any position

**Material hardness rating:** Shore 55D

**Material:** Profile body: Co-Polyester Elastomer

**Environment:** Resistant to microbes, seawater or chemical attack. Excellent UV and

ozone resistance. Material does not absorb water or swell.

**Impact velocity range:** Max. 5 m/s

**Torque max.:**

M5: 3 Nm

M8: 20 Nm

M16: 40 Nm (DIN912)

M16: 120 Nm (shouldered screw)

**Application field:** Offshore industry, Agricultural machinery, Impact panels, Conveyor systems, Stacking units, Shipbuilding, Shovels or articulated joints for construction machinery, Transport roads, Loading and lifting equipment

**Note:** Suitable for emergency stop applications and for continuous use. For applications with preloading and increased temperatures please consult ACE.

**Safety instructions:** Mounting screw should additionally be secured with Loctite.

**On request:** Special strokes, -characteristics, -spring rates, -sizes and -materials.

**TR-L**

(middle hole only TR-L-5/6/7)

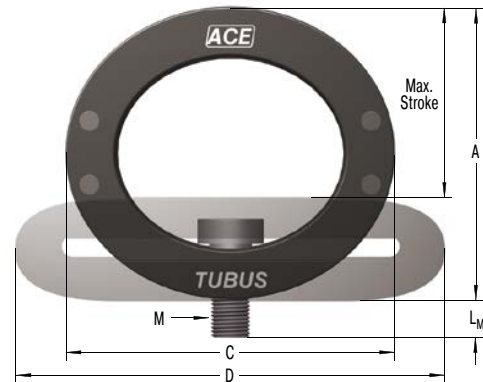
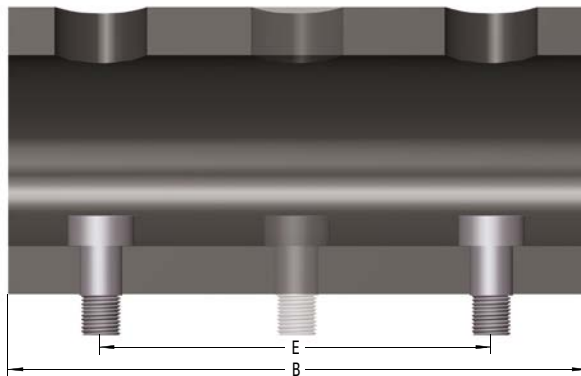

The calculation and selection of the most suitable damper should be carried out or be approved by ACE.

**Ordering Example**
**TR66-40L-2**

TUBUS Radial \_\_\_\_\_  
 Outer-Ø 66 mm \_\_\_\_\_  
 Stroke 40 mm \_\_\_\_\_  
 Long Version \_\_\_\_\_  
 Length 2 = 305 mm \_\_\_\_\_

**Performance and Dimensions**

| TYPES        | Emergency Stop                          |                            | Stroke max.<br>mm | A<br>mm | B<br>mm | C<br>mm | D<br>mm | E<br>mm | L <sub>M</sub><br>mm | M   | Weight<br>kg |
|--------------|---|----------------------------|-------------------|---------|---------|---------|---------|---------|----------------------|-----|--------------|
|              | <sup>1</sup> W <sub>s</sub><br>Nm/cycle | W <sub>s</sub><br>Nm/cycle |                   |         |         |         |         |         |                      |     |              |
| TR29-17L     | 7.2                                     | 10.9                       | 17                | 25      | 80      | 29      | 38      | 40      | 5                    | M5  | 0.044        |
| TR43-25L     | 14.0                                    | 32.7                       | 25                | 37      | 80      | 43      | 58      | 40      | 5                    | M5  | 0.072        |
| TR63-43L     | 21.9                                    | 32.0                       | 43                | 55      | 80      | 63      | 87      | 40      | 5                    | M5  | 0.106        |
| TR66-40L-1   | 102.0                                   | 143.0                      | 40                | 59      | 152     | 66      | 87      | 102     | 8                    | M8  | 0.284        |
| TR66-40L-2   | 204.0                                   | 286.0                      | 40                | 59      | 305     | 66      | 87      | 254     | 8                    | M8  | 0.580        |
| TR66-40L-3   | 306.0                                   | 428.0                      | 40                | 59      | 457     | 66      | 87      | 406     | 8                    | M8  | 0.830        |
| TR66-40L-4   | 408.0                                   | 571.0                      | 40                | 59      | 610     | 66      | 87      | 559     | 8                    | M8  | 1.130        |
| TR66-40L-5   | 510.0                                   | 714.0                      | 40                | 59      | 762     | 66      | 87      | 711     | 8                    | M8  | 1.330        |
| TR76-45L-1   | 145.0                                   | 203.0                      | 45                | 68      | 152     | 76      | 100     | 102     | 8                    | M8  | 0.380        |
| TR76-45L-2   | 290.0                                   | 406.0                      | 45                | 68      | 305     | 76      | 100     | 254     | 8                    | M8  | 0.696        |
| TR76-45L-3   | 435.0                                   | 609.0                      | 45                | 68      | 457     | 76      | 100     | 406     | 8                    | M8  | 1.130        |
| TR76-45L-4   | 580.0                                   | 812.0                      | 45                | 68      | 610     | 76      | 100     | 559     | 8                    | M8  | 1.430        |
| TR76-45L-5   | 725.0                                   | 1,015.0                    | 45                | 68      | 762     | 76      | 100     | 711     | 8                    | M8  | 1.780        |
| TR83-48L-1   | 180.0                                   | 252.0                      | 48                | 73      | 152     | 83      | 106     | 102     | 8                    | M8  | 0.480        |
| TR83-48L-2   | 360.0                                   | 504.0                      | 48                | 73      | 305     | 83      | 106     | 254     | 8                    | M8  | 0.930        |
| TR83-48L-3   | 540.0                                   | 756.0                      | 48                | 73      | 457     | 83      | 106     | 406     | 8                    | M8  | 1.380        |
| TR83-48L-4   | 720.0                                   | 1,008.0                    | 48                | 73      | 610     | 83      | 106     | 559     | 8                    | M8  | 1.810        |
| TR83-48L-5   | 900.0                                   | 1,260.0                    | 48                | 73      | 762     | 83      | 106     | 711     | 8                    | M8  | 2.260        |
| TR99-60L-1   | 270.0                                   | 378.0                      | 60                | 88      | 152     | 99      | 130     | 102     | 8                    | M8  | 0.790        |
| TR99-60L-2   | 540.0                                   | 756.0                      | 60                | 88      | 305     | 99      | 130     | 254     | 8                    | M8  | 1.290        |
| TR99-60L-3   | 810.0                                   | 1,134.0                    | 60                | 88      | 457     | 99      | 130     | 406     | 8                    | M8  | 1.940        |
| TR99-60L-4   | 1,080.0                                 | 1,512.0                    | 60                | 88      | 610     | 99      | 130     | 559     | 8                    | M8  | 2.660        |
| TR99-60L-5   | 1,350.0                                 | 1,890.0                    | 60                | 88      | 762     | 99      | 130     | 711     | 8                    | M8  | 3.100        |
| TR99-60L-6   | 1,620.0                                 | 2,268.0                    | 60                | 88      | 914     | 99      | 130     | 864     | 8                    | M8  | 3.700        |
| TR99-60L-7   | 1,890.0                                 | 2,646.0                    | 60                | 88      | 1,067   | 99      | 130     | 1,016   | 8                    | M8  | 4.300        |
| TR143-86L-1  | 600.0                                   | 840.0                      | 86                | 127     | 152     | 143     | 191     | 76      | 22                   | M16 | 1.440        |
| TR143-86L-2  | 1,200.0                                 | 1,680.0                    | 86                | 127     | 305     | 143     | 191     | 203     | 22                   | M16 | 2.900        |
| TR143-86L-3  | 1,800.0                                 | 2,520.0                    | 86                | 127     | 457     | 143     | 191     | 355     | 22                   | M16 | 3.880        |
| TR143-86L-4  | 2,400.0                                 | 3,360.0                    | 86                | 127     | 610     | 143     | 191     | 508     | 22                   | M16 | 5.420        |
| TR143-86L-5  | 3,000.0                                 | 4,200.0                    | 86                | 127     | 762     | 143     | 191     | 660     | 22                   | M16 | 6.590        |
| TR143-86L-6  | 3,600.0                                 | 5,040.0                    | 86                | 127     | 914     | 143     | 191     | 812     | 22                   | M16 | 7.890        |
| TR143-86L-7  | 4,200.0                                 | 5,880.0                    | 86                | 127     | 1,067   | 143     | 191     | 965     | 22                   | M16 | 9.190        |
| TR188-108L-1 | 1,100.0                                 | 1,540.0                    | 108               | 165     | 152     | 188     | 245     | 76      | 26                   | M16 | 2.340        |
| TR188-108L-2 | 2,200.0                                 | 3,080.0                    | 108               | 165     | 305     | 188     | 245     | 203     | 26                   | M16 | 4.640        |
| TR188-108L-3 | 3,300.0                                 | 4,620.0                    | 108               | 165     | 457     | 188     | 245     | 355     | 26                   | M16 | 6.890        |
| TR188-108L-4 | 4,400.0                                 | 6,160.0                    | 108               | 165     | 610     | 188     | 245     | 508     | 26                   | M16 | 9.190        |
| TR188-108L-5 | 5,500.0                                 | 7,700.0                    | 108               | 165     | 762     | 188     | 245     | 660     | 26                   | M16 | 11.390       |
| TR188-108L-6 | 6,600.0                                 | 9,240.0                    | 108               | 165     | 914     | 188     | 245     | 812     | 26                   | M16 | 13.640       |
| TR188-108L-7 | 7,700.0                                 | 10,780.0                   | 108               | 165     | 1,067   | 188     | 245     | 965     | 26                   | M16 | 15.940       |

<sup>1</sup> Max. energy capacity per cycle for continuous use.



## TUBUS TR-HD

### Compact powerhouse in solid material

#### Radial Damping, Heavy Duty Version

**Energy capacity 405 Nm/Cycle to 11,840 Nm/Cycle**

**Maximum stroke 12 mm to 44 mm**

Impact and collision protection: The TR-HD profile dampers are stressed in the same way as the basic model TR but offer a higher force and energy absorption with a shorter damping distance thanks to the solid design. Different damping characteristic curves can be achieved with two different co-polyester elastomer hardness levels. The slightly oval (bi-concave) shape also ensures a softer force intake.

This series absorbs a lot of energy despite the low height: a range of 405 Nm to 11,840 Nm is progressively covered by strokes of 12 mm to 44 mm. With two screws, included in the delivery, the damper can be easily and quickly fixed both horizontally or vertically. The drill hole distance is adapted if required.

These dampers are used in agricultural technology and on shovels or break joints on construction machines as well as on loading and lifting or similar equipment.



### Technical Data

**Energy capacity:** 405 Nm/Cycle to 11,840 Nm/Cycle

**Energy absorption:** 43 % to 72 %

**Dynamic force range:** 78.800 N to 812,900 N

**Operating temperature range:** -40 °C to +90 °C

**Construction size:** 42 mm to 117 mm

**Mounting:** In any position

**Material hardness rating:** Shore 40D, Shore 55D

**Material:** Profile body: Co-Polyester Elastomer

**Environment:** Resistant to microbes, seawater or chemical attack. Excellent UV and ozone resistance. Material does not absorb water or swell.

**Impact velocity range:** Max. 5 m/s

**Torque max.:**

M10: 7 Nm

M12: 12 Nm

**Application field:** Offshore industry, Agricultural machinery, Impact panels, Conveyor systems, Stacking units, Shipbuilding, Shovels or articulated joints for construction machinery, Transport roads, Loading and lifting equipment

**Note:** Suitable for emergency stop applications and for continuous use. For applications with preloading and increased temperatures please consult ACE.

**Safety instructions:** Mounting screw should additionally be secured with Loctite.

**On request:** Special strokes, -characteristics, -spring rates, -sizes and -materials.

### TR-HD

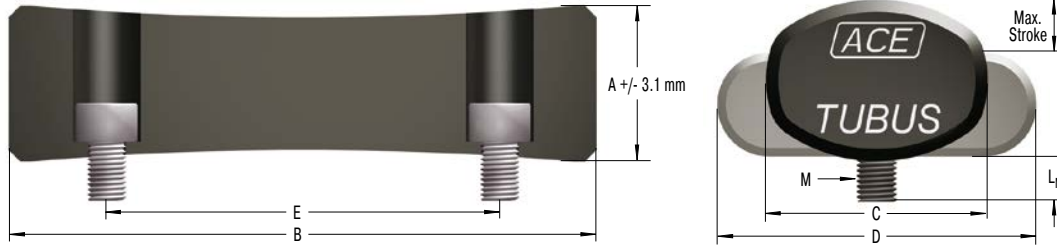

### Characteristics

#### TUBUS TR-HD

#### Force-Stroke Characteristics (static)

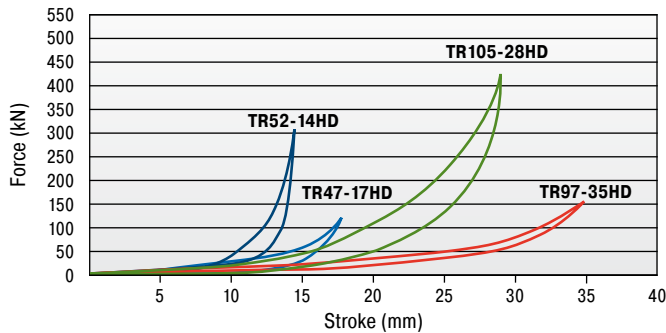

The calculation and selection of the most suitable damper should be carried out or be approved by ACE.

#### Ordering Example

TUBUS Radial \_\_\_\_\_  
 Outer-Ø 63 mm \_\_\_\_\_  
 Stroke 24 mm \_\_\_\_\_  
 Heavy Duty Version \_\_\_\_\_

**TR63-24HD**

### Performance and Dimensions

| TYPES      | Emergency Stop                          |                            | F max. static<br>N | Stroke max.<br>mm | A<br>mm | B<br>mm | C<br>mm | D<br>mm | E<br>mm | L <sub>M</sub><br>mm | M   | Weight<br>kg |
|------------|---|----------------------------|--------------------|-------------------|---------|---------|---------|---------|---------|----------------------|-----|--------------|
|            | <sup>1</sup> W <sub>3</sub><br>Nm/cycle | W <sub>3</sub><br>Nm/cycle |                    |                   |         |         |         |         |         |                      |     |              |
| TR42-14HD  | 405                                     | 567                        | 63,900             | 14                | 34      | 148     | 42      | 59      | 102     | 20                   | M10 | 0.170        |
| TR47-12HD  | 857                                     | 1,200                      | 149,600            | 12                | 31      | 150     | 47      | 58      | 102     | 19                   | M10 | 0.170        |
| TR47-17HD  | 850                                     | 1,190                      | 122,100            | 17                | 32      | 150     | 47      | 70      | 102     | 24                   | M10 | 0.180        |
| TR52-14HD  | 1,634                                   | 2,288                      | 304,500            | 14                | 29      | 153     | 52      | 69      | 102     | 22                   | M10 | 0.180        |
| TR57-21HD  | 1,194                                   | 1,672                      | 104,800            | 21                | 48      | 149     | 57      | 79      | 102     | 18                   | M10 | 0.340        |
| TR62-15HD  | 1,790                                   | 2,506                      | 245,000            | 15                | 40      | 153     | 62      | 77      | 102     | 16                   | M10 | 0.330        |
| TR62-19HD  | 2,940                                   | 4,116                      | 389,900            | 19                | 41      | 152     | 62      | 94      | 102     | 16                   | M10 | 0.360        |
| TR63-24HD  | 2,061                                   | 2,885                      | 194,400            | 24                | 46      | 153     | 63      | 92      | 102     | 20                   | M10 | 0.330        |
| TR72-26HD  | 1,700                                   | 2,380                      | 124,800            | 26                | 59      | 149     | 72      | 98      | 102     | 23                   | M12 | 0.560        |
| TR79-20HD  | 2,794                                   | 3,912                      | 289,300            | 20                | 54      | 153     | 79      | 98      | 102     | 24                   | M12 | 0.570        |
| TR79-31HD  | 2,975                                   | 4,165                      | 226,600            | 31                | 58      | 155     | 79      | 112     | 102     | 23                   | M12 | 0.560        |
| TR85-33HD  | 2,526                                   | 3,536                      | 146,100            | 33                | 71      | 150     | 85      | 111     | 102     | 23                   | M12 | 0.710        |
| TR89-21HD  | 4,438                                   | 6,213                      | 477,400            | 21                | 48      | 162     | 89      | 112     | 102     | 22                   | M12 | 0.560        |
| TR90-37HD  | 3,780                                   | 5,292                      | 240,700            | 37                | 69      | 155     | 90      | 128     | 102     | 23                   | M12 | 0.750        |
| TR93-24HD  | 3,421                                   | 4,789                      | 302,500            | 24                | 64      | 155     | 93      | 115     | 102     | 23                   | M12 | 0.790        |
| TR97-31HD  | 7,738                                   | 10,833                     | 575,200            | 31                | 63      | 159     | 97      | 129     | 102     | 21                   | M12 | 0.800        |
| TR97-35HD  | 2,821                                   | 3,949                      | 152,800            | 35                | 82      | 151     | 97      | 131     | 102     | 20                   | M12 | 1.060        |
| TR102-44HD | 4,697                                   | 6,576                      | 254,500            | 44                | 81      | 156     | 102     | 147     | 102     | 22                   | M12 | 1.050        |
| TR105-28HD | 5,641                                   | 7,897                      | 427,600            | 28                | 72      | 156     | 105     | 126     | 102     | 21                   | M12 | 1.000        |
| TR117-30HD | 8,457                                   | 11,840                     | 639,100            | 30                | 66      | 166     | 117     | 143     | 102     | 25                   | M12 | 1.010        |

<sup>1</sup> Max. energy capacity per cycle for continuous use.

# Application Examples

## TUBUS TA

### Safe end position damping

ACE TUBUS profile dampers protect the integrated loading station on a new high speed machining centre. The ACE TUBUS damper is designed to prevent overrun on the high speed loading station of a Camshaft machining centre used in the automobile industry. In the event that the drive train fails during operation or incorrect data is inputted the ACE TUBUS damper absorbs the impact preventing costly damage to the machine. The TA98-40 TUBUS damper impressed engineers with this exceptionally long service life in operation. When used as an emergency stop the TUBUS damper can absorb up to 73 % of the impact energy.



Safety with ultra high speed operation

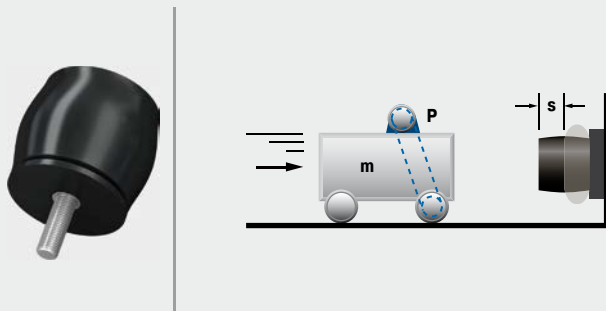

## TUBUS TS

### Safe braking of maintenance boats

The maintenance of wind turbines in open seas has long resulted in damage to maintenance boats. Because of impact velocity and swell, an increase in the boat's mass of up to 20 percent must be taken into account when landing on a rigid mooring structure. It is only since the landing operation has been carried out with the aid of the ACE company's TUBUS series that cable repair and maintenance work on wind turbines has been made safe for both personnel and equipment. TUBUS of the type TS84-43 are seawater resistant and can withstand ambient temperatures from -40 °C to + 90 °C.



Seawater-resistant, robust TUBUS profile dampers made of co-polyester elastomer allow boats and crew to dock safely  
Wals Diving and Marine Service, 1970AC Ijmuiden, Netherlands

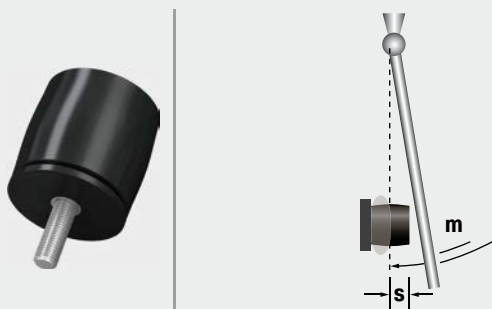

Issue 07.2017 – Specifications subject to change

### TUBUS TS

#### Protection of drive used in space treadmill

When training in zero gravity, a harness with bungee cords is used to ensure that trainees do not become disengaged. Three ACE profile dampers with a linear-working facility are utilized in this case. One so-called TUBUS is positioned in the pneumatic cylinder, while the other two are put in place in the rest of the system. All the dampers have the task of protecting the system if the treadmill drive belts become damaged. Otherwise, the cylinder would reach a very high speed and become seriously damaged at the end of the stroke.



TUBUS are used to protect a fitness machine in zero gravity  
QinetiQ Space nv, 9150 Kruibeke, Belgium

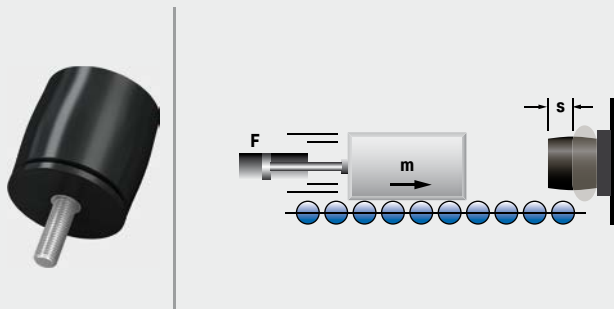

### TUBUS TR

#### Gentle damping for electric scooters

TUBUS profile dampers make driving an e-scooter a real experience. The footboard of an electric scooter should be dampened to enable the driver to experience a comfortable ride even over potholes and other bumpy surfaces. Ideally, the characteristic line should be furnished with a soft increase in force over a long stroke. The elegant look of the scooter as well as the folding mechanism designed to save space have not allowed the use of feasible damper solutions up to now. Inferior alternatives such as rubber dampers made of polyurethane or simple steel springs could not be considered from the start. The TUBUS profile damper TR52-32H offered the perfect solution with its compact construction design paired with progressive damping action.



Profile dampers increase the riding comfort of an electric scooter

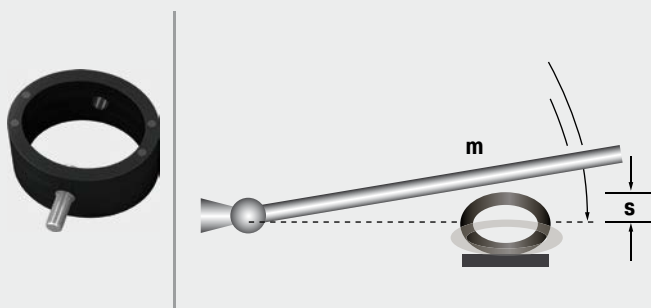

# Special Profile Dampers

## Costs-effective tuning for your pressing tools

**ACE provides TUBUS profile dampers in many variations. Special solutions for presses can now be cost-effectively achieved with down holder dampers, damping plugs, lift dampers and press dampers from ACE.**

They replace the PU-springs previously used in the automotive industry. It was no longer possible for them to fulfil the required tasks due to the higher return stroke speeds in modern pressing tools. Made of co-polyester elastomers, the TUBUS special takes care of the protection of mounting bolts and insert bolts much more reliably. On the one hand they protect a so-called down holders during the return stroke after the forming of sheet metal parts, and on the other they function as protection for hoisting lifters.

High reliability

Long service life

High power and energy absorption

Efficient working through higher cycle rates

Extreme abrasion hardness and shear strength

Noise reduction





## TUBUS Special Profile Dampers

### A wide range of solutions for your tools

Small but effective: These versatile, custom-manufactured components make all the difference during sheet metal forming in the automotive and tool industries thanks to long service lives and high power absorption.



#### TUBUS Down Holder Dampers

##### The innovation as a substitute for overburdened PU springs

The axial-functioning elements are ideal for different diameters of mounting bolts from M10 to M30 in the press tools. They increase clock rates, service lives and reliability during increased cushioning strokes there.



#### TUBUS Lift Dampers

##### The brother of the down holder damper

Used in the end position damping in ProgDie presses, they sit on the mounting bolts of the spring-loaded belt guide rails or hoisting lifters in the bottom part of the tool of the follow-on composite tool, protect it and accelerate production.



#### TUBUS Damping Plugs

##### A special kind of emergency plug

These side-mounted, radial damping elements also protect the mounting bolts and insert bolts during the opening of the pressing tools. They are available in four different sizes and are used in large tools.



#### TUBUS Press Dampers

##### When a side effect (nearly) becomes the main thing

All TUBUS specials additionally reduce noise. In press dampers, used particularly in eccentric presses by manufacturers of large household appliances, this is however the main task. Screwed into a hole pocket, they also effectively protect the tools.

More information about TUBUS special profile dampers can be found in our special catalogue and on our Website

[www.ace-ace.com / Downloads](http://www.ace-ace.com/Downloads)



# Damping Pads

## Customised damping technology

**With damping pads from the SLAB series, ACE provides solutions to effectively slow down impact loads over large and small surfaces. This means that these products are found in a wide range of damping technologies from ACE where oscillation begins or where damaging impacts in construction designs need to be slowed over a large surface.**

The ACE SLAB pads, available to choose in any size, absorb static loads from 3 N/cm<sup>2</sup> to 30 N/cm<sup>2</sup> and can be either cut to size two-dimensionally according to each requirement or designed as a moulded part. It is simply adhered to assemble. The standard plate heights are between 12.5 mm and 25 mm. Many different coatings clear the way for numerous applications and not least because they can be used in a temperature range from -5 °C to +50 °C.

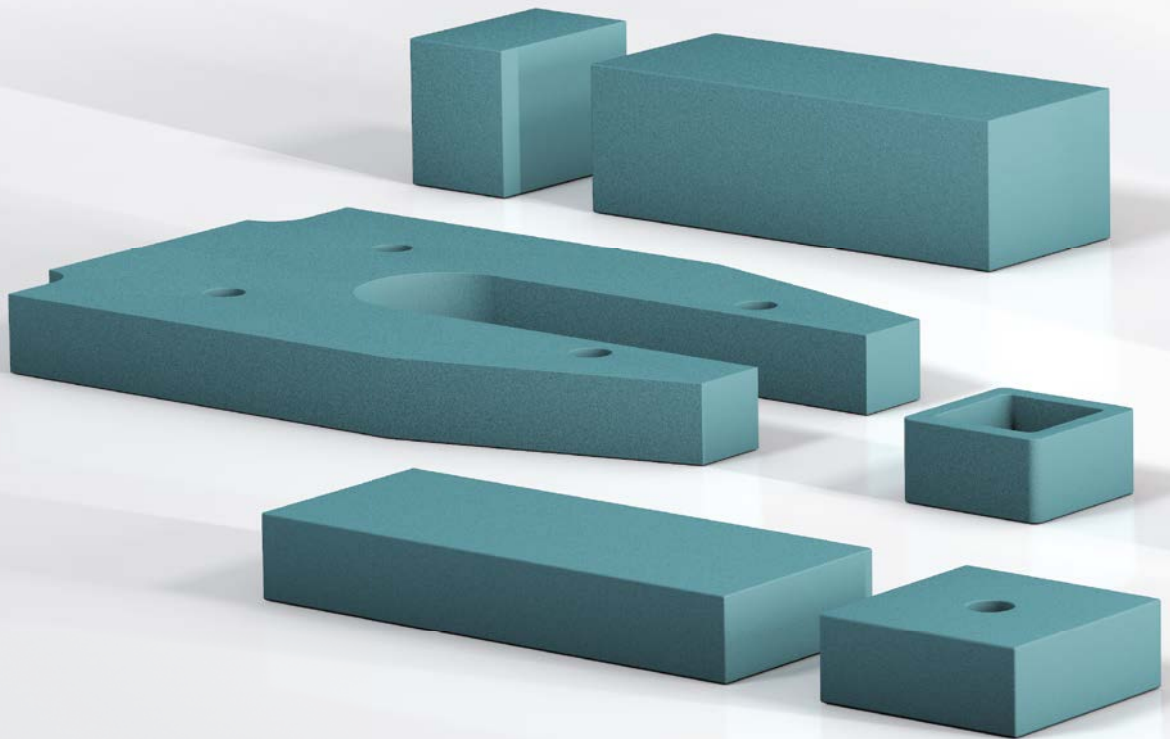

## Individual Pad Cutting

**SLAB pads pre-assembled for each project**

Whether pads, cuts or drawing parts, stocked SLAB pads in combination with our freely programmable cutting machine ensure maximum flexibility with excellent delivery speed.

**Fast, flexible and adapted to your conditions.**

*Ask for special solutions !!!*

Can be integrated quickly and cost-effectively

Immense inner damping

Pad thicknesses up to 80 mm on request

Can be assembled with CNC cutting machines

Patented formula

Environmentally-friendly H<sub>2</sub>O-foamed

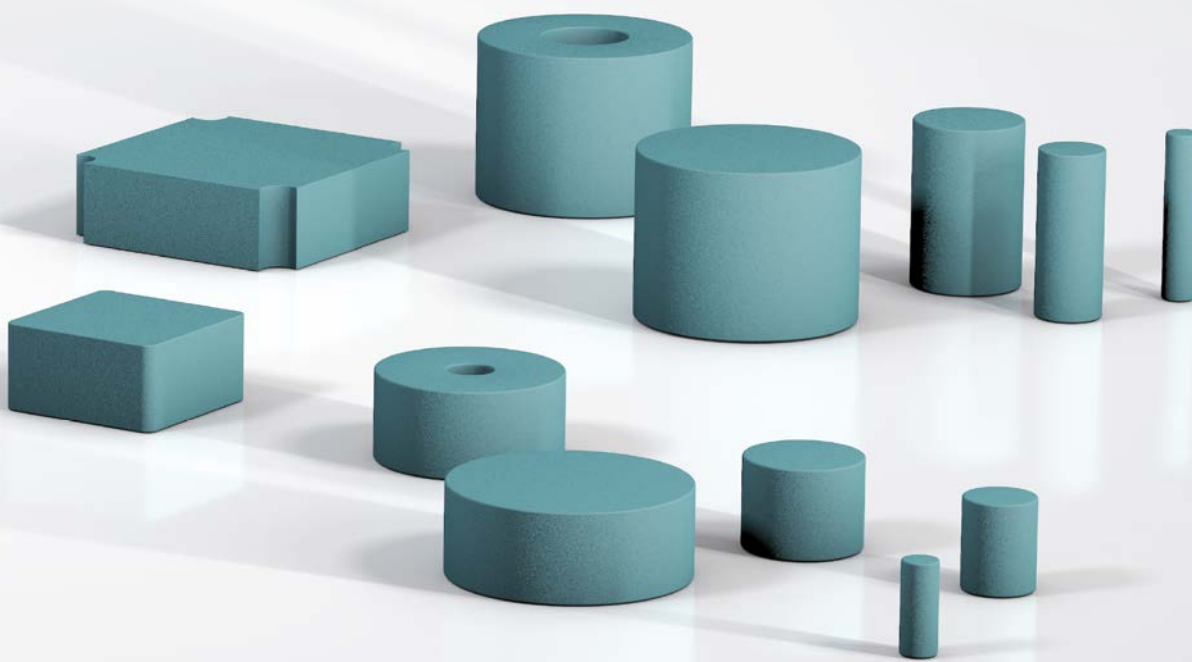

## SLAB 030 to SLAB 300

### Energy absorption in pad format

#### Confectioning and Combinable

**Energy capacity 3.1 Nm/Cycle to 210 Nm/Cycle**

**Stroke 6.5 mm to 12.5 mm**

Tailor made damping material in pad format: SLAB damping pads are made of a viscoelastic PUR-material. They absorb impact loads extremely effectively and are also suitable for insulating or damping vibration.

The pad series SL-030 to SL-300 are quickly adapted to the relevant type of application. This is in part achieved through the configuration of the calculating tool or directly by the ACE specialist engineers. Furthermore, this is possible because the standard material can be cut exactly and quickly to any customer requirement with our new cutting system. It is also possible to obtain a sample to find an optimum solution.

The SLAB damping pads are proven impact or collision protection. They are used on luggage and transport belts, conveyor systems, pneumatic, electromechanical and hydraulic drives as well as on linear carriages.

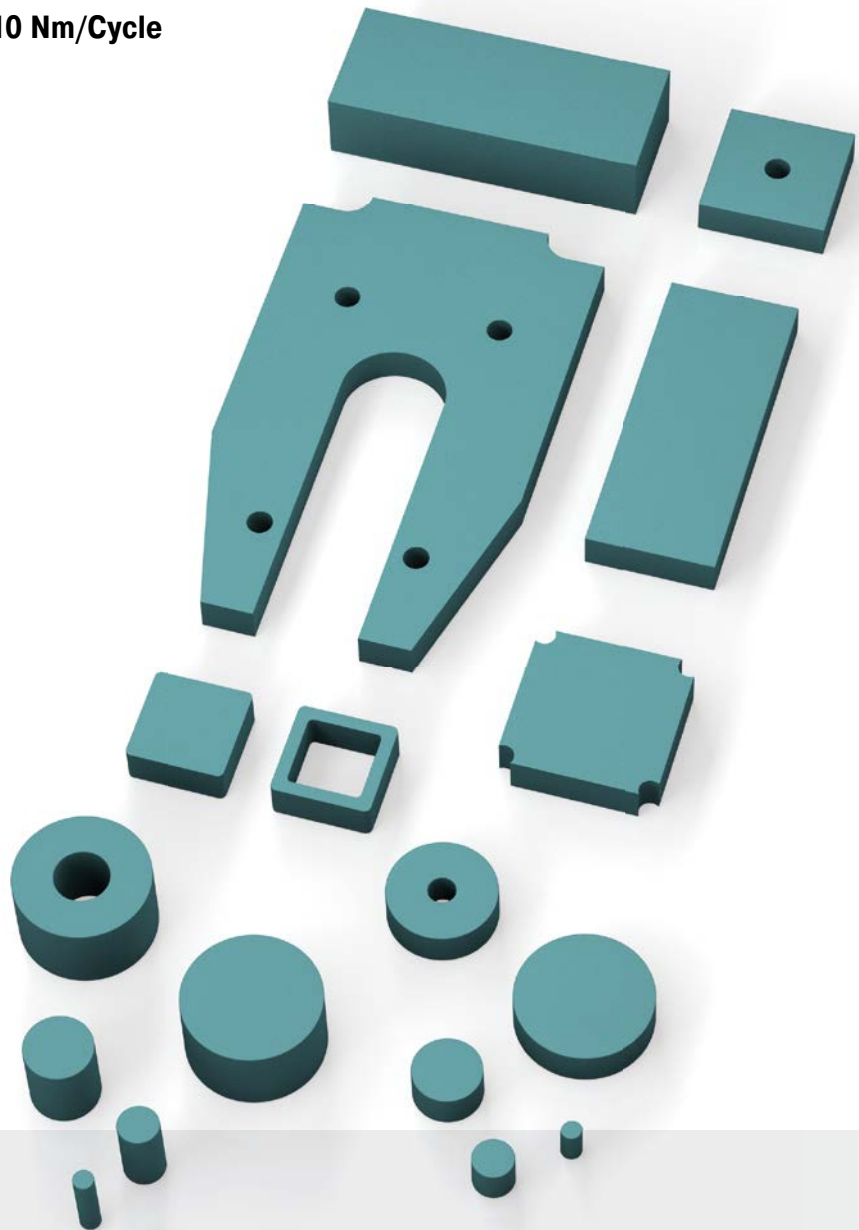

#### Technical Data

**Energy capacity:** 3.1 Nm/Cycle to 210 Nm/Cycle

**Standard density:**

SL-030 = approx. 220 kg/m<sup>3</sup>

SL-100 = approx. 440 kg/m<sup>3</sup>

SL-300 = approx. 680 kg/m<sup>3</sup>

**Standard colour:** Green

**Dimensions:**

Widths: up to 1,500 mm

Lengths: up to 5,000 mm

Thicknesses: 12.5 mm and 25 mm

**Environment:** Resistant against ozone and UV radiation. Chemical resistancy on request.

**Operating temperature range:** -5 °C to +50 °C

**Material:** Profile body: Mixed cellular PUR-Elastomer (polyurethane)

**Application field:** Linear slides, Handling modules, Luggage and transport belts, Impact panels, Pipeline insulation, Foundation mounting, Conveyor technology, Electronic systems and controls, Medical technology

**Note:** Possibilities for cutting: Water jet cutting, stamping, splitting, sawing and drilling

**Safety instructions:** Fire rating: B2, normally flammable, according to DIN 4102

**On request:** Special versions with further dimensions such as thicknesses, colours, shapes and drawing parts e.g. curves. Different wear layers.

### SL-030-12

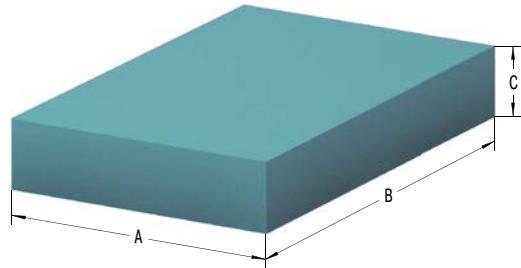

### Characteristics

#### Type SL-030-12

#### Force-Stroke Characteristic (dynamic)

#### Stroke Utilization 6.5 mm

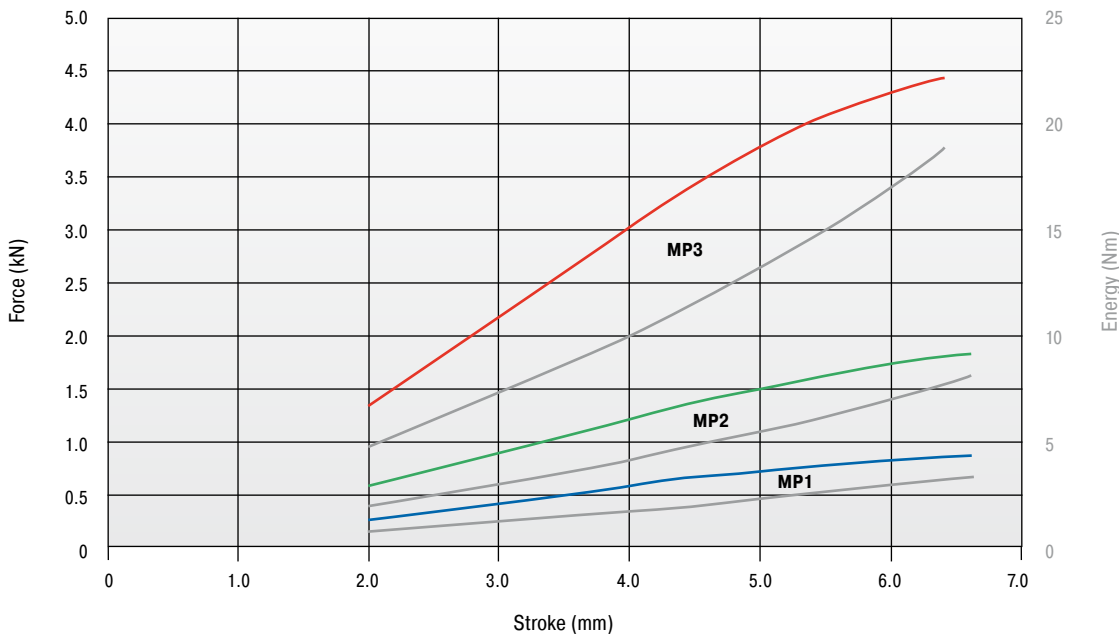

#### Load data

Dynamic load, impact velocity: approx. 1 m/s



The chosen damping plate should be tested by the customer on the specific application.

#### Ordering Example

ACE-SLAB \_\_\_\_\_ **SL-030-12-Dxxxx**  
 Material Type \_\_\_\_\_  
 Material Thickness 12.5 mm \_\_\_\_\_  
 Customers Specific Dimension/Shape \_\_\_\_\_  
 (D-Number is assigned by ACE)

### Performance and Dimensions

| TYPES           | <sup>1</sup> W <sub>3</sub> max.<br>Nm/cycle | <sup>1</sup> Stroke<br>mm | A<br>mm | B<br>mm | C<br>mm | Area<br>mm <sup>2</sup> | Standard density<br>kg/m <sup>3</sup> | Return Time<br>s | Weight<br>kg |
|-----------------|--|---------------------------|---------|---------|---------|-------------------------|---------------------------------------|------------------|--------------|
| SL-030-12-D-MP1 | 3.1  | 6.5                       | 50.0    | 50.0    | 12.5    | 2,500                   | 200                                   | 4                | 0.006        |
| SL-030-12-D-MP2 | 8.0  | 6.5                       | 70.7    | 70.7    | 12.5    | 5,000                   | 200                                   | 4                | 0.013        |
| SL-030-12-D-MP3 | 19.0   | 6.5                       | 100.0   | 100.0   | 12.5    | 10,000                  | 200                                   | 4                | 0.025        |

<sup>1</sup> Maximum energy absorption in terms of area graded pad sizes as a reference for the correct selection of material and pad size. The energy absorption depends on the individual impact surface and stroke utilization.

Confectioning and Combinable

**SL-030-25**

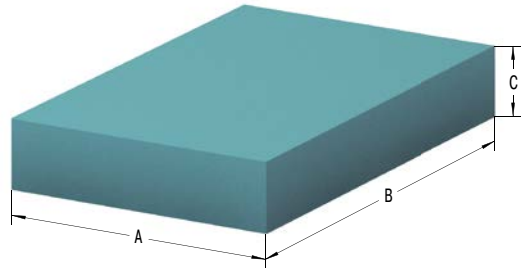

**Characteristics**

**Type SL-030-25**

**Force-Stroke Characteristic (dynamic)**

**Stroke Utilization 12.5 mm**

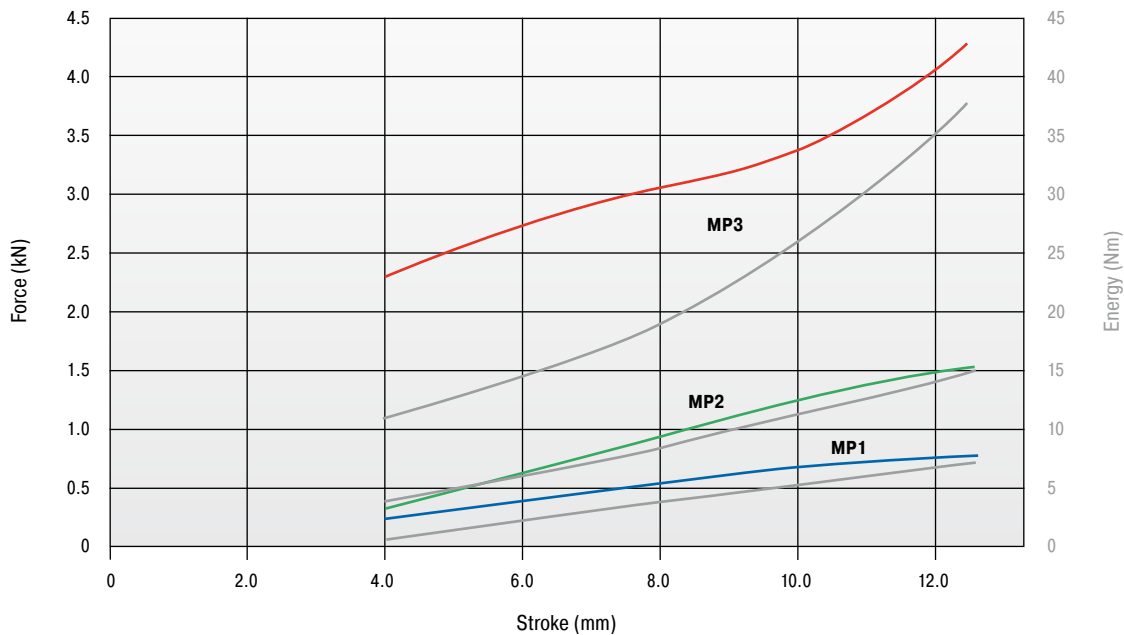

**Load data**

Dynamic load, impact velocity: approx. 1 m/s



The chosen damping plate should be tested by the customer on the specific application.

**Ordering Example**

ACE-SLAB \_\_\_\_\_ **SL-030-25-Dxxxx**  
 Material Type \_\_\_\_\_  
 Material Thickness 25 mm \_\_\_\_\_  
 Customers Specific Dimension/Shape \_\_\_\_\_  
 (D-Number is assigned by ACE)

**Performance and Dimensions**

| TYPES           | <sup>1</sup> W <sub>3</sub> max.<br>Nm/cycle | <sup>1</sup> Stroke<br>mm | A<br>mm | B<br>mm | C<br>mm | Area<br>mm <sup>2</sup> | Standard density<br>kg/m <sup>3</sup> | Return Time<br>s | Weight<br>kg |
|-----------------|--|---------------------------|---------|---------|---------|-------------------------|---------------------------------------|------------------|--------------|
| SL-030-25-D-MP1 | 6.7  | 12.5                      | 50.0    | 50.0    | 25.0    | 2,500                   | 200                                   | 5                | 0.013        |
| SL-030-25-D-MP2 | 15.0   | 12.5                      | 70.7    | 70.7    | 25.0    | 5,000                   | 200                                   | 5                | 0.025        |
| SL-030-25-D-MP3 | 42.0   | 12.5                      | 100.0   | 100.0   | 25.0    | 10,000                  | 200                                   | 5                | 0.050        |

<sup>1</sup> Maximum energy absorption in terms of area graded pad sizes as a reference for the correct selection of material and pad size. The energy absorption depends on the individual impact surface and stroke utilization.

### SL-100-12

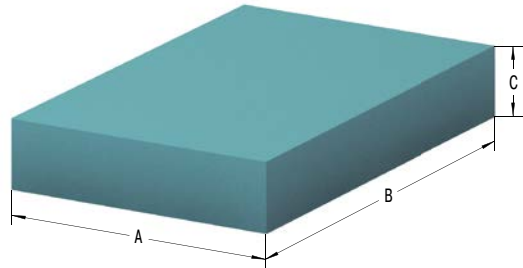

### Characteristics

#### Type SL-100-12

#### Force-Stroke Characteristic (dynamic)

#### Stroke Utilization 6.5 mm

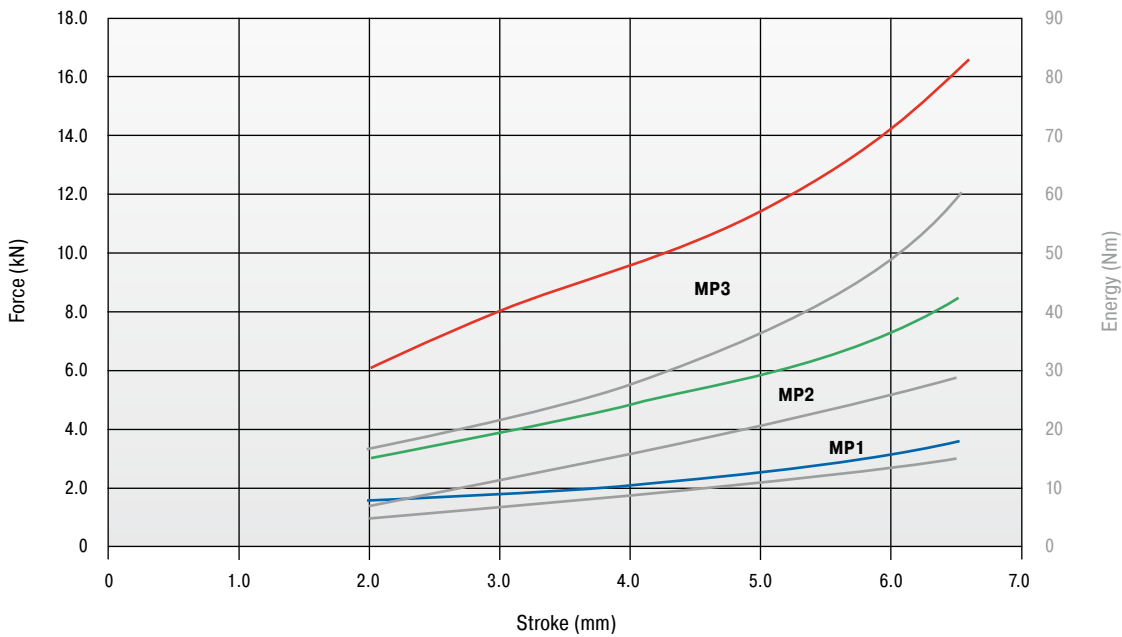

#### Load data

Dynamic load, impact velocity: approx. 1 m/s



The chosen damping plate should be tested by the customer on the specific application.

#### Ordering Example

ACE-SLAB \_\_\_\_\_ **SL-100-12-Dxxxx**  
 Material Type \_\_\_\_\_  
 Material Thickness 12.5 mm \_\_\_\_\_  
 Customers Specific Dimension/Shape \_\_\_\_\_  
 (D-Number is assigned by ACE)

### Performance and Dimensions

| TYPES           | <sup>1</sup> W <sub>3</sub> max.<br>Nm/cycle | <sup>1</sup> Stroke<br>mm | A<br>mm | B<br>mm | C<br>mm | Area<br>mm <sup>2</sup> | Standard density<br>kg/m <sup>3</sup> | Return Time<br>s | Weight<br>kg |
|-----------------|--|---------------------------|---------|---------|---------|-------------------------|---------------------------------------|------------------|--------------|
| SL-100-12-D-MP1 | 15.0   | 6.5                       | 50.0    | 50.0    | 12.5    | 2,500                   | 440                                   | 4                | 0.014        |
| SL-100-12-D-MP2 | 30.0   | 6.5                       | 70.7    | 70.7    | 12.5    | 5,000                   | 440                                   | 4                | 0.028        |
| SL-100-12-D-MP3 | 60.0   | 6.5                       | 100.0   | 100.0   | 12.5    | 10,000                  | 440                                   | 4                | 0.055        |

<sup>1</sup> Maximum energy absorption in terms of area graded pad sizes as a reference for the correct selection of material and pad size. The energy absorption depends on the individual impact surface and stroke utilization.



SL-100-25

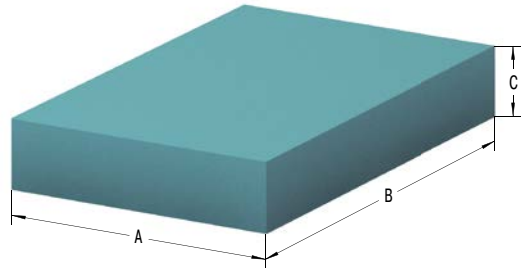

Characteristics

Type SL-100-25

Force-Stroke Characteristic (dynamic)

Stroke Utilization 12.5 mm

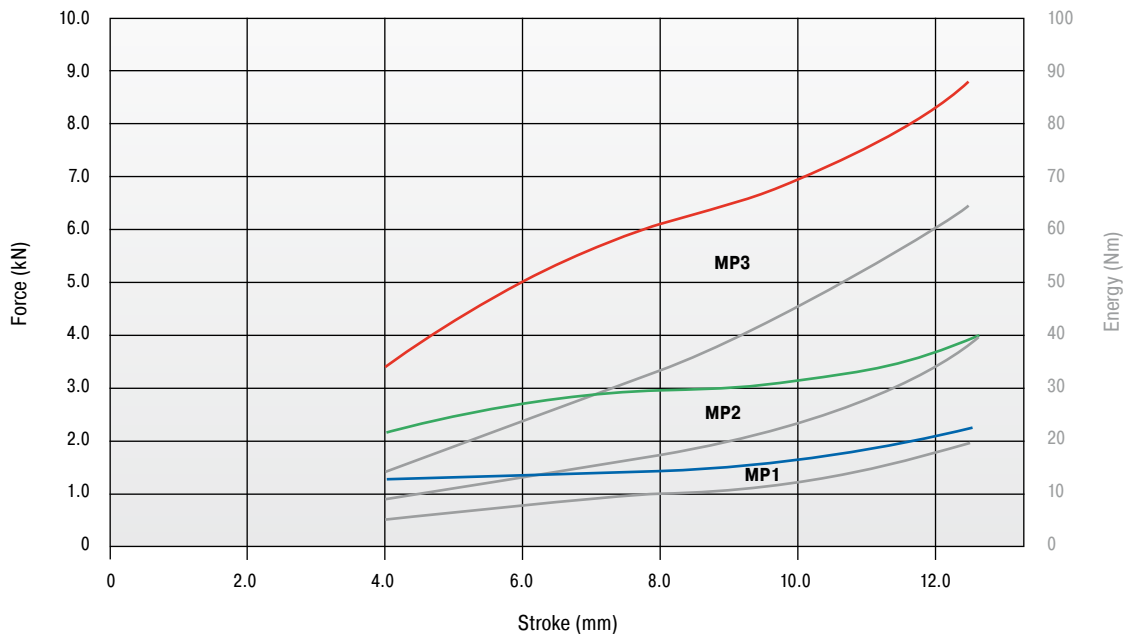

Load data

Dynamic load, impact velocity: approx. 1 m/s

|                |                             |
|----------------|-----------------------------|
| — (Red line)   | Area 10,000 mm <sup>2</sup> |
| — (Green line) | Area 5,000 mm <sup>2</sup>  |
| — (Blue line)  | Area 2,500 mm <sup>2</sup>  |

The chosen damping plate should be tested by the customer on the specific application.

Ordering Example

ACE-SLAB \_\_\_\_\_ **SL-100-25-Dxxxx**  
 Material Type \_\_\_\_\_  
 Material Thickness 25 mm \_\_\_\_\_  
 Customers Specific Dimension/Shape \_\_\_\_\_  
 (D-Number is assigned by ACE)

Performance and Dimensions

| TYPES           | <sup>1</sup> W <sub>3</sub> max.<br>Nm/cycle | <sup>1</sup> Stroke<br>mm | A<br>mm | B<br>mm | C<br>mm | Area<br>mm <sup>2</sup> | Standard density<br>kg/m <sup>3</sup> | Return Time<br>s | Weight<br>kg |
|-----------------|--|---------------------------|---------|---------|---------|-------------------------|---------------------------------------|------------------|--------------|
| SL-100-25-D-MP1 | 20.0   | 12.5                      | 50.0    | 50.0    | 25.0    | 2,500                   | 440                                   | 5                | 0.028        |
| SL-100-25-D-MP2 | 40.0   | 12.5                      | 70.7    | 70.7    | 25.0    | 5,000                   | 440                                   | 5                | 0.055        |
| SL-100-25-D-MP3 | 63.0   | 12.5                      | 100.0   | 100.0   | 25.0    | 10,000                  | 440                                   | 5                | 0.110        |

<sup>1</sup> Maximum energy absorption in terms of area graded pad sizes as a reference for the correct selection of material and pad size. The energy absorption depends on the individual impact surface and stroke utilization.

### SL-300-12

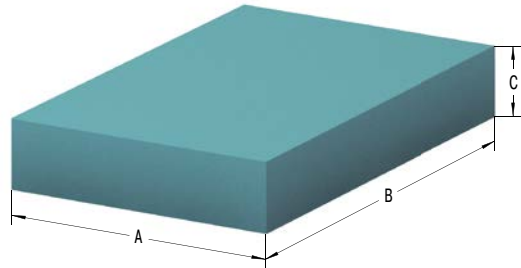

### Characteristics

#### Type SL-300-12

#### Force-Stroke Characteristic (dynamic)

#### Stroke Utilization 6.5 mm

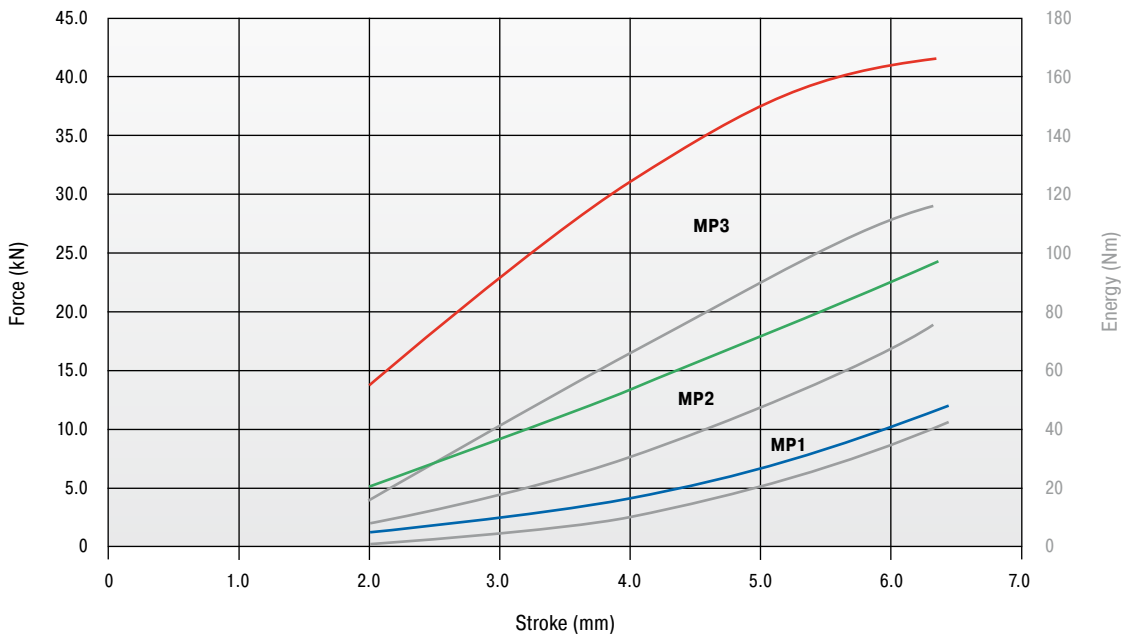

#### Load data

Dynamic load, impact velocity: approx. 1 m/s



The chosen damping plate should be tested by the customer on the specific application.

#### Ordering Example

ACE-SLAB \_\_\_\_\_ **SL-300-12-Dxxxx**  
 Material Type \_\_\_\_\_  
 Material Thickness 12.5 mm \_\_\_\_\_  
 Customers Specific Dimension/Shape \_\_\_\_\_  
 (D-Number is assigned by ACE)

### Performance and Dimensions

| TYPES           | <sup>1</sup> W <sub>3</sub> max.<br>Nm/cycle | <sup>1</sup> Stroke<br>mm | A<br>mm | B<br>mm | C<br>mm | Area<br>mm <sup>2</sup> | Standard density<br>kg/m <sup>3</sup> | Return Time<br>s | Weight<br>kg |
|-----------------|--|---------------------------|---------|---------|---------|-------------------------|---------------------------------------|------------------|--------------|
| SL-300-12-D-MP1 | 38.0   | 6.5                       | 50.0    | 50.0    | 12.5    | 2,500                   | 680                                   | 3                | 0.021        |
| SL-300-12-D-MP2 | 65.0   | 6.5                       | 70.7    | 70.7    | 12.5    | 5,000                   | 680                                   | 3                | 0.043        |
| SL-300-12-D-MP3 | 121.0  | 6.5                       | 100.0   | 100.0   | 12.5    | 10,000                  | 680                                   | 3                | 0.085        |

<sup>1</sup> Maximum energy absorption in terms of area graded pad sizes as a reference for the correct selection of material and pad size. The energy absorption depends on the individual impact surface and stroke utilization.

Confectioning and Combinable

**SL-300-25**

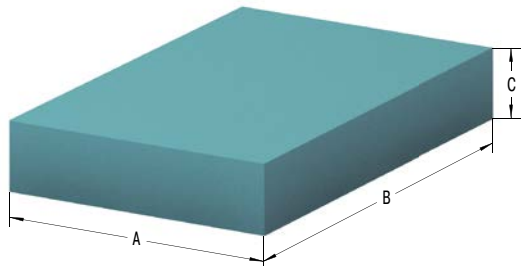

**Characteristics**

Type SL-300-25

Force-Stroke Characteristic (dynamic)

Stroke Utilization 12.5 mm

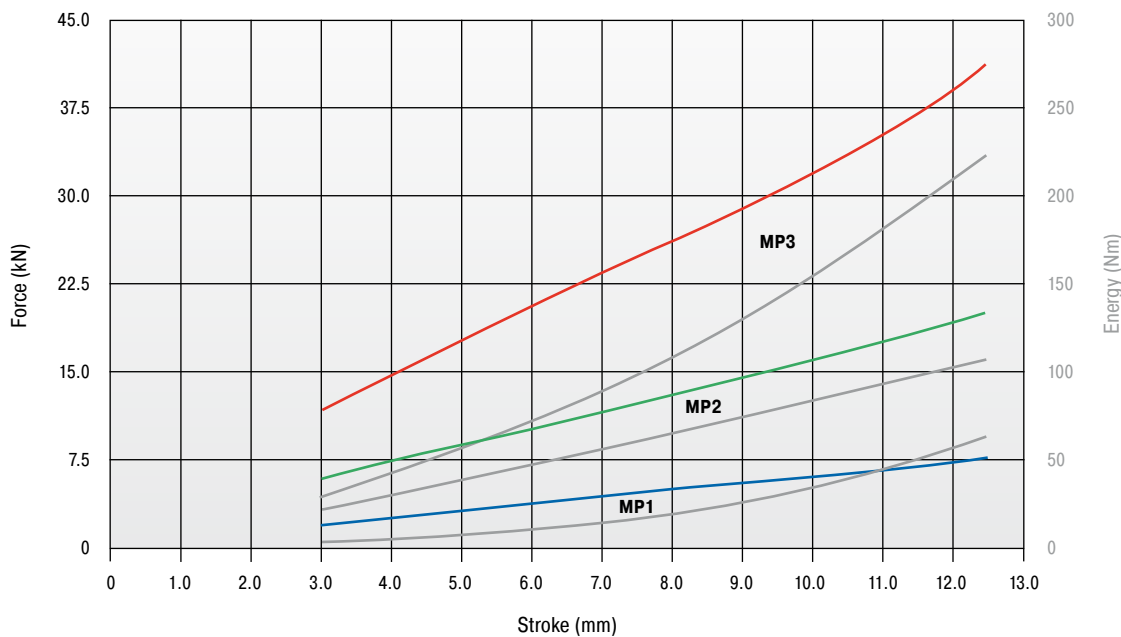

**Load data**

Dynamic load, impact velocity: approx. 1 m/s



The chosen damping plate should be tested by the customer on the specific application.

**Ordering Example**

ACE-SLAB \_\_\_\_\_ **SL-300-25-Dxxxx**  
 Material Type \_\_\_\_\_  
 Material Thickness 25 mm \_\_\_\_\_  
 Customers Specific Dimension/Shape \_\_\_\_\_  
 (D-Number is assigned by ACE)

**Performance and Dimensions**

| TYPES           | <sup>1</sup> W <sub>3</sub> max.<br>Nm/cycle | <sup>1</sup> Stroke<br>mm | A<br>mm | B<br>mm | C<br>mm | Area<br>mm <sup>2</sup> | Standard density<br>kg/m <sup>3</sup> | Return Time<br>s | Weight<br>kg |
|-----------------|--|---------------------------|---------|---------|---------|-------------------------|---------------------------------------|------------------|--------------|
| SL-300-25-D-MP1 | 59.0   | 12.5                      | 50.0    | 50.0    | 25.0    | 2,500                   | 680                                   | 4                | 0.043        |
| SL-300-25-D-MP2 | 101.0  | 12.5                      | 70.7    | 70.7    | 25.0    | 5,000                   | 680                                   | 4                | 0.085        |
| SL-300-25-D-MP3 | 210.0  | 12.5                      | 100.0   | 100.0   | 25.0    | 10,000                  | 680                                   | 4                | 0.170        |

<sup>1</sup> Maximum energy absorption in terms of area graded pad sizes as a reference for the correct selection of material and pad size. The energy absorption depends on the individual impact surface and stroke utilization.

## Bonding of Polyurethane (PUR) Elastomers

Cellular and compact parts of polyurethane (PUR) elastomers SLAB damping pads can be bonded according to the following recommendations. If treatment instructions are followed, the strengths of the bonded joint can be equivalent to the elastomer material itself.

### 1. General Information

To achieve the required bonding strength it is necessary to ensure the correct adhesive is chosen for each individual application.

#### Contact bonding material

Thin adhesive film, with little filling of the gaps. Correcting or moving of the areas covered with bonding material is no longer possible after the first contact is made (contact effect).

Once a bonding is separated, the bonding process must be renewed.

Please note that creases, ripples or blisters cannot be straightened once the contact is made.

#### Hardening bonding material

(As thin as possible) the film of glue fills the joint. The gluing can be done after the edges are brought together.

### 2. Preparation

The preparation of bonding surfaces is of significant importance for the bonding strength. The surfaces must be adapted to each other and available in plain, clean form.

#### Careful removal of

Adhesive remnants, oil, fat, separating agents, dirt, dust, scales, molding layers, protective coating, finish, paint, sweat etc.

#### Mechanical support

Stripping, brushing, scraping, grinding, sandblasting.

#### Chemical support

Degreasing (washing off with grease remover), etching, priming; pay attention to chemical resistancy on the following page!

In general, SLAB damping pads in sheet form can be bonded without pretreatment. Molded parts, with or without special skin, have to be cleaned from left-over separating agents, if necessary by grinding. When bonding with other materials like plastic, wood, metal or concrete, mechanical and/or chemical additives have to be used.

The adhesive has to be prepared according to the formula, observing the manufacturer's recommendations. The adhesive film is also to be carefully applied pursuant to these details. (Tools: brush, spatula, adhesive spreader, airless spray gun).

#### Contact bonding material

Apply the non-gap-filling adhesive film to both bonding surfaces – the thinner, the better. To close the pores of low density materials, two layers may be necessary.

#### Hardening bonding material

Apply evenly. Possible irregularities can be compensated by the film thickness.

### 3. Bonding

When using contact bonding material, the flash off time has to be kept in mind. Especially, with systems containing water instead of usual solvents, the adhesive film must be as dry as possible in order to pass the 'finger test' – no marks appear when touching the adhesive surface. When using hardening bonding material, the parts have to be joined immediately after applying the bonding material.

### 4. Pressing

**Contact bonding material**      Contact pressure up to 0.5 N/mm<sup>2</sup>  
**Hardening bonding material**      Fix firmly

It is important to carefully follow the manufacturer's instructions with regard to processing temperature, hardening time and earliest possible loading.

### 5. Selection of Approved Bonding Materials

Because of the variety of materials that can be bonded together as well as numerous suitable bonding materials, we refer you to a worldwide leading producer of bonding and sealing materials.

Sika Deutschland GmbH  
 Kornwestheimer Straße 103-107  
 D-70439 Stuttgart  
 T +49 (0)711 - 8009-0  
 F +49 (0)711 - 8009-321  
 info@de.sika.com  
 http://www.sika.de

## Chemical Resistance

### Test (following DIN 53428)

Exposure time of the medium: 6 weeks at room temperature, but for concentrated acids and bases as well as solvents: 7 days at room temperature

### Evaluation Criteria

Changing of tensile strength and elongation of break (dry samples), change in volume

### Evaluation Standard

|                                 |   |
|---------------------------------|---|
| <b>1 Excellent resistance</b>   | change in characteristics <10 %                 |
| <b>2 Good resistance</b>        | change in characteristics between 10 % and 20 % |
| <b>3 Conditional resistance</b> | change in characteristics partly above 20 %     |
| <b>4 Not resistant</b>          | change in characteristics all above 20 %        |

All information is based on our current knowledge and experiences. We reserve the rights for changes towards product refinement.

### Chemical Resistance

| Water/Watery Solutions   | SL-030 to SL-300 |
|--------------------------|------------------|
| Water                    | 1                |
| Iron (III) chloride 10 % | 1                |
| Sodium carbonate         | 1                |
| Sodium chlorate 10 %     | 1                |
| Sodium chloride 10 %     | 1                |
| Sodium nitrate 10 %      | 1                |
| Tensides (div.)          | 1                |
| Hydrogen peroxide 3 %    | 1                |
| Laitance                 | 1                |

### Oils and Greases

|                           |                                  |
|---------------------------|----------------------------------|
| ASTM Oil No. 1            | 1                                |
| ASTM Oil No. 3            | 1                                |
| Laitance                  | 2                                |
| Hydraulic oils            | depends on consistency/additives |
| Motor oil                 | 1                                |
| Formwork oil              | 1                                |
| High performance grease   | 1-2                              |
| Railroad switch lubricant | 1-2                              |

### Acids and Bases

|                             |   |
|-----------------------------|---|
| Formic acid 5 %             | 3 |
| Acetic acid 5 %             | 2 |
| Phosphoric acid 5 %         | 1 |
| Nitic acid 5 %              | 4 |
| Hydrochloric acid 5 %       | 1 |
| Sulphuric acid 5 %          | 1 |
| Ammonia solution 5 %        | 1 |
| Caustic potash solution 5 % | 1 |
| Caustic soda solution 5 %   | 1 |

| Solvents                 | SL-030 to SL-300 |
|--------------------------|------------------|
| Acetone                  | 4                |
| Diesel/Fuel oil          | 2                |
| Carburetor fuel/Benzine  | 3                |
| Glycerin                 | 1                |
| Glycols                  | 1-2              |
| Cleaning solvents/Hexane | 1                |
| Methanol                 | 3                |
| Aromatic hydrocarbons    | 4                |

### Other Factors

|                             |     |
|-----------------------------|-----|
| Hydrolysis *                | 1   |
| Ozone                       | 1   |
| UV radiation and weathering | 1-2 |
| Biological resistance       | 1   |

\* 28 days, 70 °C, 95 % relative humidity

## Sample Pads and Sample Sets

### Sample Pads

| Part Number         | Dimensions and Type   |
|---------------------|---|
| SL-030-12-D-MP4     | 220 x 150 x 12.5 mm   |
| SL-030-12-D-MP4-V+K | 220 x 150 x 12.5 mm + layer for wear protection 2 mm, self-adhesive on one side |
| SL-030-25-D-MP4     | 220 x 150 x 25 mm   |
| SL-100-12-D-MP4     | 220 x 150 x 12.5 mm   |
| SL-100-12-D-MP4-V+K | 220 x 150 x 12.5 mm + layer for wear protection 2 mm, self-adhesive on one side |
| SL-100-25-D-MP4     | 220 x 150 x 25 mm   |
| SL-300-12-D-MP4     | 220 x 150 x 12.5 mm   |
| SL-300-12-D-MP4-V+K | 220 x 150 x 12.5 mm + layer for wear protection 2 mm, self-adhesive on one side |
| SL-300-25-D-MP4     | 220 x 150 x 25 mm   |
| SL-030-12-D-MP5     | 1500 x 800 x 12 mm  |
| SL-030-25-D-MP5     | 1500 x 800 x 25 mm  |
| SL-100-12-D-MP5     | 1500 x 800 x 12 mm  |
| SL-100-25-D-MP5     | 1500 x 800 x 25 mm  |
| SL-300-12-D-MP5     | 1500 x 800 x 12 mm  |
| SL-300-25-D-MP5     | 1500 x 800 x 25 mm  |

### Sample Sets

Individually arranged sample sets are available on request!  
 3 densities. Dimensions: 50 x 50 mm, 70.7 x 70.7 mm and 100 x 100 mm. Thickness: 12.5 and 25 mm

### Set "Sizes"

comprising 1 model, 1 type of thickness, 3 sizes = 3 sample pads

| Part Number | Content              | Dimensions                                 |
|-------------|----------------------|--|
| SL-SET-1.1  | SL-030-12-MP1 to MP3 | 50 x 50 mm / 70.7 x 70.7 mm / 100 x 100 mm |
| SL-SET-1.2  | SL-030-25-MP1 to MP3 | 50 x 50 mm / 70.7 x 70.7 mm / 100 x 100 mm |
| SL-SET-1.3  | SL-100-12-MP1 to MP3 | 50 x 50 mm / 70.7 x 70.7 mm / 100 x 100 mm |
| SL-SET-1.4  | SL-100-25-MP1 to MP3 | 50 x 50 mm / 70.7 x 70.7 mm / 100 x 100 mm |
| SL-SET-1.5  | SL-300-12-MP1 to MP3 | 50 x 50 mm / 70.7 x 70.7 mm / 100 x 100 mm |
| SL-SET-1.6  | SL-300-25-MP1 to MP3 | 50 x 50 mm / 70.7 x 70.7 mm / 100 x 100 mm |

### Set "Types"

comprising 3 models, 1 type of thickness, 1 size = 3 sample plates

| Part Number | Content   | Dimensions     |
|-------------|---|----------------|
| SL-SET-2.1  | SL-030-12-D-MP1, SL-100-12-D-MP1, SL-300-12-D-MP1 | 50 x 50 mm     |
| SL-SET-2.2  | SL-030-25-D-MP1, SL-100-25-D-MP1, SL-300-25-D-MP1 | 50 x 50 mm     |
| SL-SET-2.3  | SL-030-12-D-MP2, SL-100-12-D-MP2, SL-300-12-D-MP2 | 70.7 x 70.7 mm |
| SL-SET-2.4  | SL-030-25-D-MP2, SL-100-25-D-MP2, SL-300-25-D-MP2 | 70.7 x 70.7 mm |
| SL-SET-2.5  | SL-030-12-D-MP3, SL-100-12-D-MP3, SL-300-12-D-MP3 | 100 x 100 mm   |
| SL-SET-2.6  | SL-030-25-D-MP3, SL-100-25-D-MP3, SL-300-25-D-MP3 | 100 x 100 mm   |



## Application Examples

### SL-030, TA

#### Damping combination SLAB and TUBUS

SLAB-TUBUS-Combination ensures fast luggage transport. Airports endeavour to shorten air passengers' waiting times as much as possible. This aim is met with a solution especially developed for luggage transport systems and has solved previous damping issue. Transport carriers with a weight of up to 120 kg can now be moved at the desired conveyor belt speeds. A SLAB-combination of the material SL-030-12(25)-Dxxxx together with two TA40-16 type TUBUS profile dampers are used here.



Fast luggage transport for airport customers

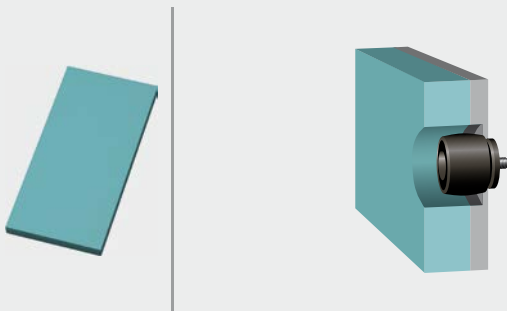

### SL-030

#### Noise reduction

ACE-SLAB damping pads protect man and machine. At the beginning of the construction phase of a modern processing centre at the end position, a 25 kg cable channel collided with force against the housing and produced a deafening noise and mechanical strain on the energy chain. A reliable solution for compliance with the operational parameters was realized with the SL-030-25-Dxxxx type ACE-SLAB damping pads even before the milling machine was finished.



Low-noise energy chain

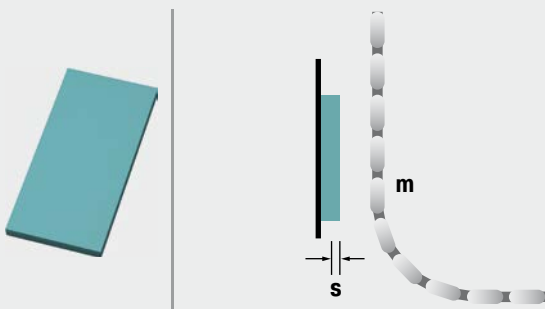

### SL-030

#### Impact reduction in ring form

ACE-SLAB damping pads make tyre transport safer. Developed for absorbing the impact of forces, the ACE-SLAB damping pads SL-030-121-Dxxxx applied in this tyre testing system are ideal for protecting the sliding parts of the machine during quality tests. The individual customisation of the ring form of the centre arm and simple integration into the equipment also support the decision for applying these innovative absorber elements.

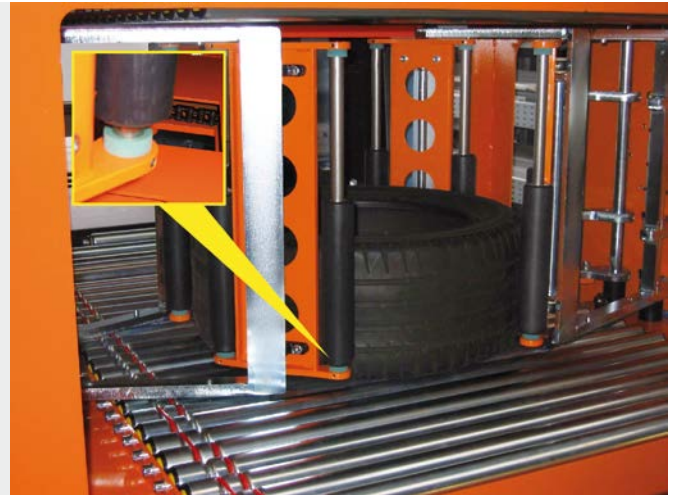

Perfectly fitted machine protection  
SDS Systemtechnik GmbH, 75365 Calw, Germany

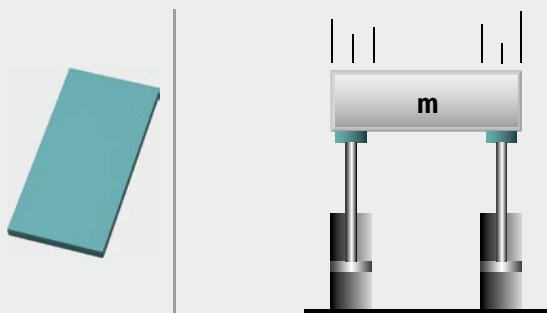

### SL-030

#### Impact protection for large areas

ACE-SLAB damping pads offer impact protection for wooden battens. To protect wooden battens with differing weights and impact speeds of approx. 2 m/s, the SLAB-material SL-030-12-Dxxxx was screwed across the whole surface between two steel sheets in this application. This creates an even damping effect over the whole impact area, which protects the impact surfaces of the battens from an excessive impact load. The minimisation of recoil as well as reduction of noise are further positive side effects of this construction.



Impact protection for wooden battens

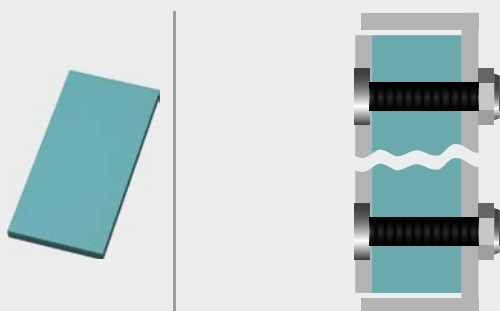

# Motion Control

Gas Springs – Push Type, Gas Springs – Pull Type  
Hydraulic Dampers, Hydraulic Feed Controls  
Rotary Dampers



# Perfect Support for Muscle Power

## Customised to suit your applications

**The various products from ACE in this segment give a new quality to any type of movement. Anyone who wants to raise or lower loads, regulate the feed of an object to the precise millimetre or gently decelerate rotating or linear movements will find the right helper here.**

ACE also convinces with industry quality in this area. And the innovative solutions also correspond with the maximum requirements of ergonomics and individuality, including with customised, fillable gas springs.



# Industrial Gas Springs – Push Type

## Lifting and lowering for smart people

**Anyone who wants to lift or lower loads with control and without excessive strength relies on the industrial gas push type springs from ACE. These maintenance-free, ready-to-install machine elements, which are available from stock, support sheer muscle power and reliably open and hold.**

Available with body diameters of 8 mm to 70 mm and forces from 10 N to 13,000 N, ACE gas push type springs are characterised by a huge variety and maximum service life. The first is achieved thanks to the number of available connections and fittings for simple attachment and the latter with high quality design and materials. Whether they are made of steel or stainless steel, these components make any work easier and also make a particularly good impression visually in every branch.

Ready-to-install and universally applicable

Modular end fittings and mounting brackets

Calculation program for individual design

No own construction costs

Maintenance-free

Available with valve ex stock





## Function of a Gas Spring – Push Type

ACE gas springs are individually filled to a predetermined pressure to suit a customer's requirement (extension Force  $F_1$ ). The cross-sectional area of the piston rod and filling pressure determines the extension force.

During the compression of the piston rod, nitrogen flows through an orifice in the piston from the full bore side of the piston to the annulus. The nitrogen is compressed by the volume of the piston rod. As the piston rod is compressed the pressure increases, so increasing the reaction force (progression). The force depends on the proportional relationship between the piston rod and the inner tube diameter, which is approximately linear.

### Calculation Principles

#### Force-Stroke Characteristics of Gas Spring (Push Type)

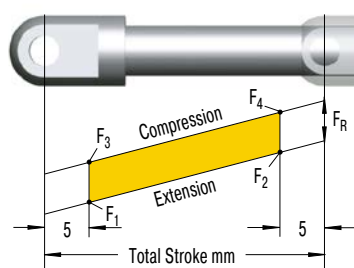

$F_1$  = nominal force at 20 °C  
(this is the pressure figure normally used when specifying the gas spring)

$F_2$  = force in the complete compressed position

When compressing the piston rod, there is an additional friction force caused by the contact pressure of the seals (this **only** occurs **during the compression stroke**):

$F_3$  = force at the beginning of the compression stroke

$F_4$  = force at the end of the compression stroke

#### Gas Springs (Push Type)

| TYPES | Progression approx. % | <sup>1</sup> Friction $F_R$ approx. in N |
|-------|-----------------------|--|
| GS-8  | 29 - 33 <sup>2</sup>  | 10                                       |
| GS-10 | 13 - 16 <sup>2</sup>  | 10                                       |
| GS-12 | 20 - 35 <sup>2</sup>  | 20                                       |
| GS-15 | 30 - 40 <sup>2</sup>  | 20                                       |
| GS-19 | 24 - 35 <sup>2</sup>  | 30                                       |
| GS-22 | 30 - 40 <sup>2</sup>  | 30                                       |
| GS-28 | 63 - 76 <sup>2</sup>  | 40                                       |
| GS-40 | 38 - 50 <sup>2</sup>  | 50                                       |
| GS-70 | 25                    | 50                                       |

<sup>1</sup> Depending on the filling force

<sup>2</sup> Depending on the stroke

**Progression:** (the slope of the force line in the diagram above) is due to the reduction of the internal gas volume as the piston rod moves from its initial position to its fully stroked position. The approx. progression values given above for standard springs can be altered on request.

**Effect of temperature:** The nominal  $F_1$  figure is given at 20 °C. An increase of 10 °C will increase force by 3.4 %.

**Filling tolerances:** -20 N to +40 N or 5 % to 7 %. Depending on size and extension force the tolerances can differ.

Free calculation service see page 172!

## Industrial Gas Springs – Push Type



### GS-8 to GS-70

Valve Technology

**Individual stroke length and extension forces**

Hoods, Shutters, Machine housing, Conveyor systems

Page 134



### GS-8-V4A to GS-40-VA

Valve Technology, Stainless Steel

**With food grade oil according to FDA approval**

Hoods, Shutters, Machine housing, Conveyor systems

Page 144



### GST-40 Tandem

Valve Technology

**Optimised dual force for heavy flaps and wide angle applications**

Hoods, Shutters, Machine housing, Conveyor systems

Page 154



## GS-8 to GS-70

### Individual stroke length and extension forces

#### Valve Technology

**Force range 10 N to 13,000 N**

**Stroke 20 mm to 1,000 mm**

Universal and tailor made: ACE industrial gas push type springs of the NEWTONLINE family offer perfect support of muscle power with forces from 10 to 13,000 N with body diameter of 8 to 70 mm. With their high quality features the NEWTONLINE gas springs form the industry standard. These durable and sealed systems are ready for installation, maintenance-free and filled with pressurised nitrogen gas.

They are supplied filled according to individual customer pressure requirements and maybe adjusted later by use of the inbuilt valve. The free of charge ACE calculation service designs the gas springs with mounting points specifically for the particular application. A variety of additional components makes assembly even easier and allows universal application of the gas springs.

ACE industrial gas push type springs are used in industrial applications, mechanical engineering and medical technology as well as in the electronics, automobile and furniture industries.

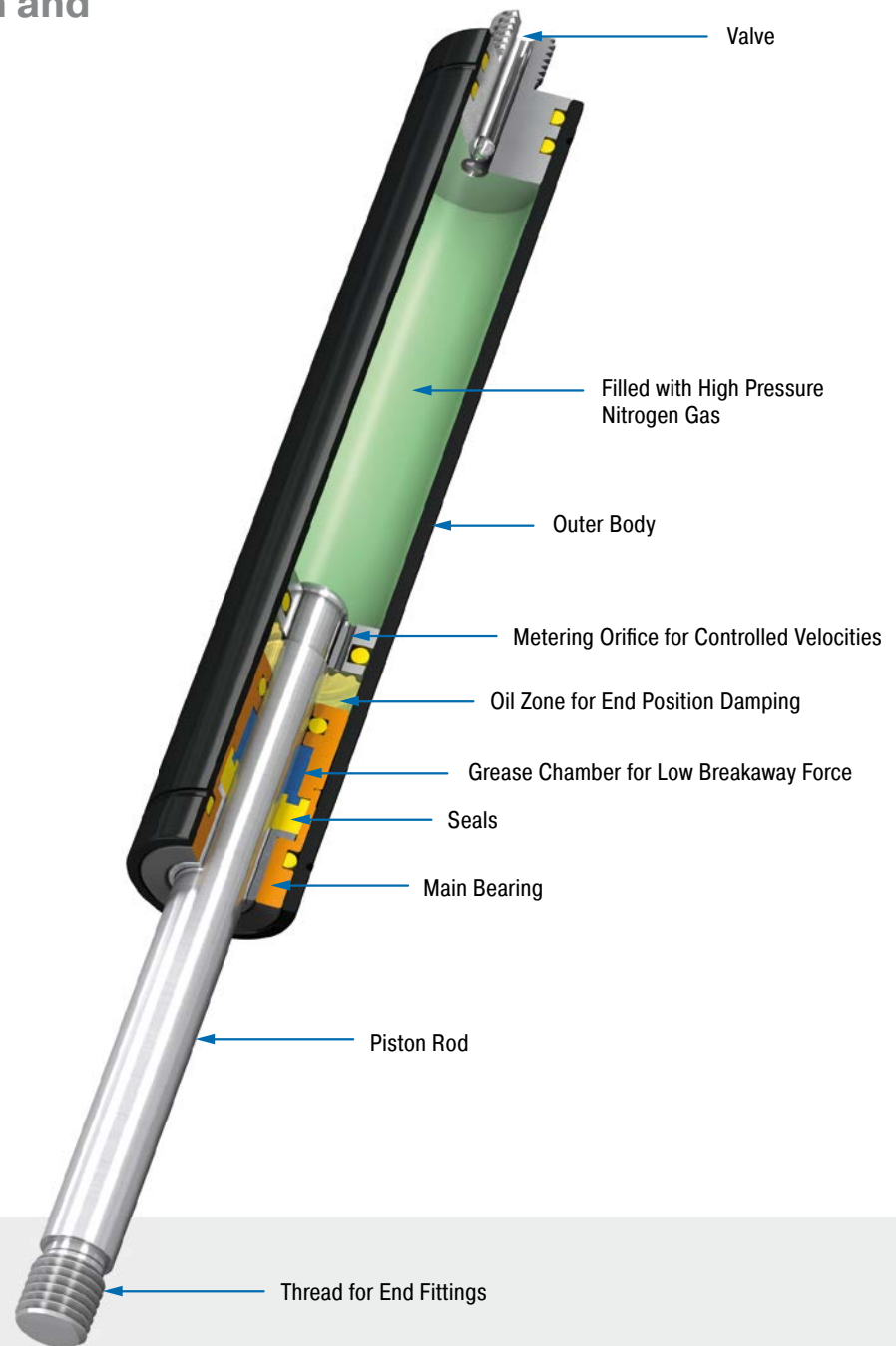

#### Technical Data

**Extension force:** 10 N to 13,000 N

**Piston rod diameter:** Ø 3 mm to Ø 30 mm

**Progression:** approx. 13 % to 76 % (depending on size and stroke)

**Lifetime:** Approx. 10,000 m

**Operating temperature range:** -20 °C to +80 °C

**Material:** Outer body: coated steel; Piston rod: steel or stainless steel with wear-resistant coating; End fittings: zinc plated steel

**Operating fluid:** nitrogen gas and oil

**Mounting:** We recommend mounting with piston rod downwards to take advantage of the built-in end position damping.

**End position damping length:** Approx. 5 mm to 70 mm (depending on the stroke)

**Positive stop:** External positive stop at the end of stroke provided by the customer.

**Application field:** hoods, shutters, machine housing, conveyor systems, control boxes, furniture industry, jacking applications, assembly stations, vehicle technology, folding elements

**Note:** Increased break-away force if unit has not moved for some time.

**End fittings:** They are interchangeable and if necessary must be positively secured by the customer to prevent unscrewing.

**Safety instructions:** Gas springs (push type) should not be installed under pre-tension.

**On request:** Special oils and other special options. Alternative accessories. Different end position damping and extension speed.

Valve Technology, Extension force 10 N to 100 N (compressed up to 133 N)

### End Fitting

### Standard Dimensions

### End Fitting

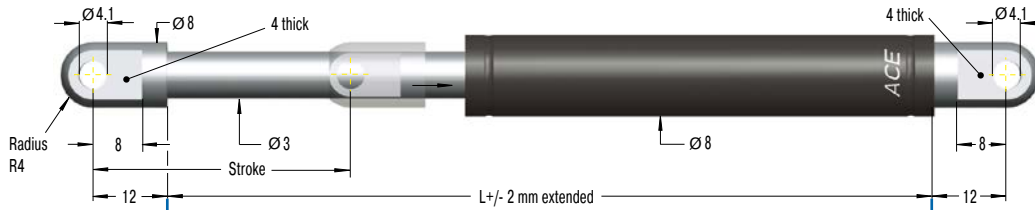
**A3,5**

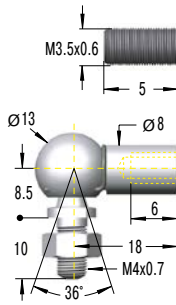
**Eye A3,5**  
max. force 370 N

**B3,5**
**C3,5**

### Performance and Dimensions

| TYPES   | Stroke<br>mm | L extended<br>mm | Extension force max.<br>N |
|---------|--------------|------------------|---------------------------|
| GS-8-20 | 20           | 72               | 100                       |
| GS-8-30 | 30           | 92               | 100                       |
| GS-8-40 | 40           | 112              | 100                       |
| GS-8-50 | 50           | 132              | 100                       |
| GS-8-60 | 60           | 152              | 100                       |
| GS-8-80 | 80           | 192              | 100                       |

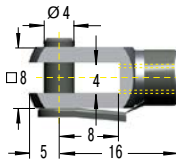
**Stud Thread B3,5**
**Angle Ball Joint C3,5**  
max. force 370 N

**D3,5**

### Ordering Example

**GS-8-30-AC-30**

Type (Push Type) \_\_\_\_\_  
 Body Ø (8 mm) \_\_\_\_\_  
 Stroke (30 mm) \_\_\_\_\_  
 Piston Rod End Fitting A3,5 \_\_\_\_\_  
 Body End Fitting C3,5 \_\_\_\_\_  
 Nominal Force F<sub>1</sub> 30 N \_\_\_\_\_

**Clevis Fork D3,5**  
max. force 370 N

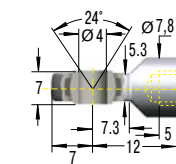
**E3,5**

Mounting accessories see from  
page 200.

**Swivel Eye E3,5**  
max. force 370 N

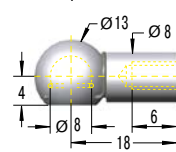
**G3,5**

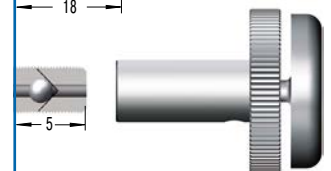
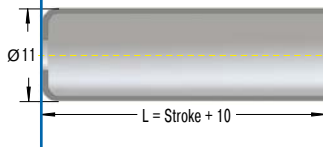
**Ball Socket G3,5**  
max. force 370 N

**Rod Shroud W3,5-8**

**Adjuster Knob  
DE-GAS-3,5**  
See page 175.

### Technical Data

**Extension force:** 10 N to 100 N (compressed up to 133 N)

**Progression:** Approx. 29 % to 33 %

**Operating temperature range:** -20 °C to +80 °C

**Material:** Outer body: coated steel; Piston rod: stainless steel (1.4301/1.4305, AISI 304/303); End fittings: zinc plated steel

**Mounting:** We recommend mounting with piston rod downwards to take advantage of the built-in end position damping.

**End position damping length:** approx. 5 mm (depending on the stroke)

**Positive stop:** External positive stop at the end of stroke provided by the customer.

**Note:** Increased break-away force if unit has not moved for some time.

**End fittings:** They are interchangeable and if necessary must be positively secured by the customer to prevent unscrewing.

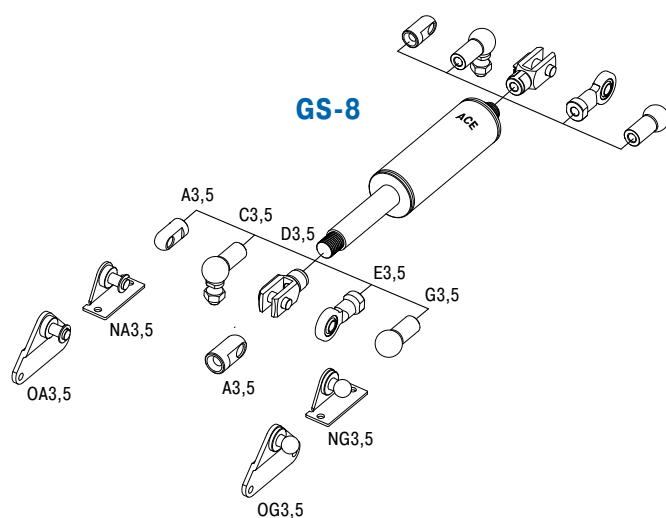
**Safety instructions:** Gas springs (push type) should not be installed under pre-tension.

Valve Technology, Extension force 10 N to 100 N (compressed up to 116 N)

End Fitting

Standard Dimensions

End Fitting

A3,5

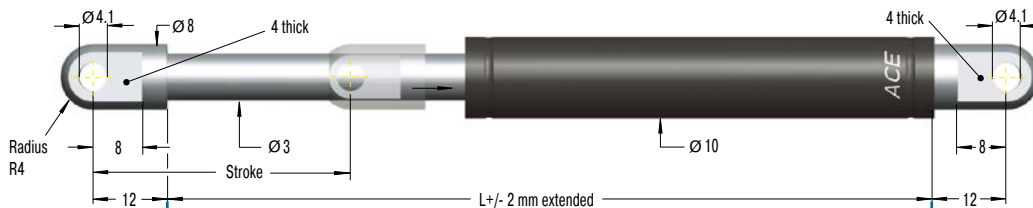

Eye A3,5  
max. force 370 N

B3,5

C3,5

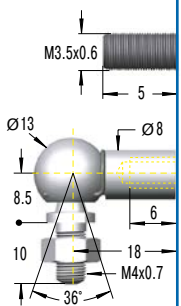

Performance and Dimensions

| TYPES    | Stroke mm | L extended mm | Extension force max. N |
|----------|-----------|---------------|------------------------|
| GS-10-20 | 20        | 72            | 100                    |
| GS-10-30 | 30        | 92            | 100                    |
| GS-10-40 | 40        | 112           | 100                    |
| GS-10-50 | 50        | 132           | 100                    |
| GS-10-60 | 60        | 152           | 100                    |
| GS-10-80 | 80        | 192           | 100                    |

Stud Thread B3,5

Angle Ball Joint C3,5  
max. force 370 N

D3,5

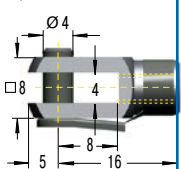

Ordering Example

GS-10-80-AC-60

Type (Push Type) \_\_\_\_\_  
 Body Ø (10 mm) \_\_\_\_\_  
 Stroke (80 mm) \_\_\_\_\_  
 Piston Rod End Fitting A3,5 \_\_\_\_\_  
 Body End Fitting C3,5 \_\_\_\_\_  
 Nominal Force F<sub>1</sub> 60 N \_\_\_\_\_

Clevis Fork D3,5  
max. force 370 N

E3,5

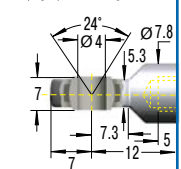

Swivel Eye E3,5  
max. force 370 N

G3,5

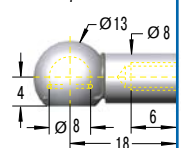

Ball Socket G3,5  
max. force 370 N

Rod Shroud W3,5-10

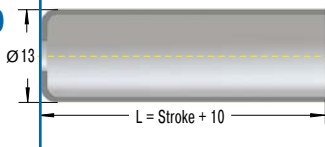

Mounting accessories see from page 200.

Adjuster Knob DE-GAS-3,5  
See page 175.

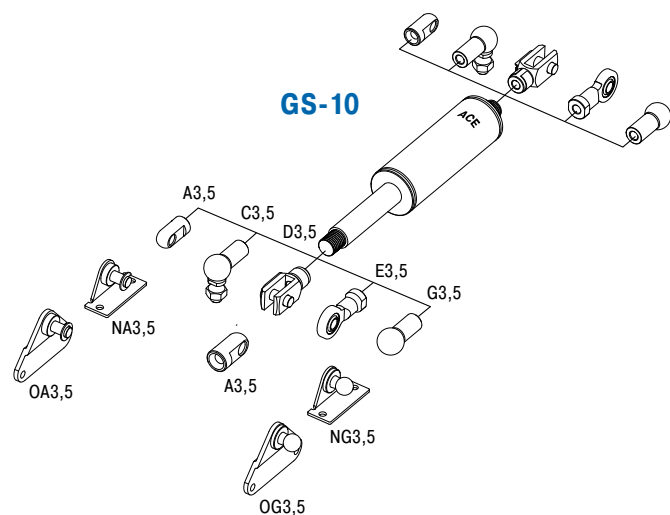

Technical Data

**Extension force:** 10 N to 100 N (compressed up to 116 N)

**Progression:** Approx. 13 % to 16 %

**Operating temperature range:** -20 °C to +80 °C

**Material:** Outer body: coated steel; Piston rod: stainless steel (1.4301/1.4305, AISI 304/303); End fittings: zinc plated steel

**Mounting:** We recommend mounting with piston rod downwards to take advantage of the built-in end position damping.

**End position damping length:** approx. 5 mm (depending on the stroke)

**Positive stop:** External positive stop at the end of stroke provided by the customer.

**Note:** Increased break-away force if unit has not moved for some time.

**End fittings:** They are interchangeable and if necessary must be positively secured by the customer to prevent unscrewing.

**Safety instructions:** Gas springs (push type) should not be installed under pre-tension.

Valve Technology, Extension force 15 N to 180 N (compressed up to 243 N)

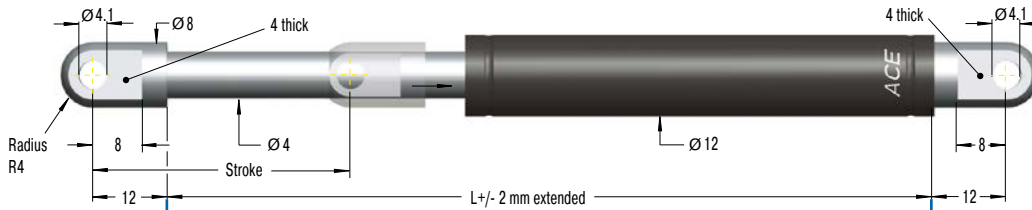
**End Fitting**
**Standard Dimensions**
**End Fitting**
**A3,5**

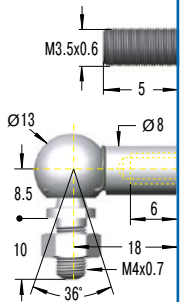
**Eye A3,5**  
max. force 370 N

**B3,5**
**C3,5**

**Performance and Dimensions**

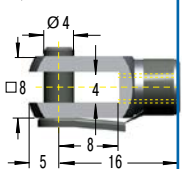
| TYPES     | Stroke<br>mm | L extended<br>mm | Extension force max.<br>N |
|-----------|--------------|------------------|---------------------------|
| GS-12-20  | 20           | 72               | 180                       |
| GS-12-30  | 30           | 92               | 180                       |
| GS-12-40  | 40           | 112              | 180                       |
| GS-12-50  | 50           | 132              | 180                       |
| GS-12-60  | 60           | 152              | 180                       |
| GS-12-80  | 80           | 192              | 150                       |
| GS-12-100 | 100          | 232              | 150                       |
| GS-12-120 | 120          | 272              | 120                       |
| GS-12-150 | 150          | 332              | 100                       |

**Stud Thread B3,5**
**Angle Ball Joint C3,5**  
max. force 370 N

**D3,5**

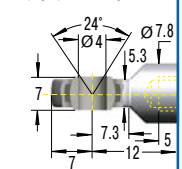
**Ordering Example**
**GS-12-100-AA-30**

Type (Push Type) \_\_\_\_\_  
 Body Ø (12 mm) \_\_\_\_\_  
 Stroke (100 mm) \_\_\_\_\_  
 Piston Rod End Fitting A3,5 \_\_\_\_\_  
 Body End Fitting A3,5 \_\_\_\_\_  
 Nominal Force F<sub>1</sub> 30 N \_\_\_\_\_

**E3,5**

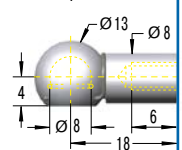
**Clevis Fork D3,5**  
max. force 370 N

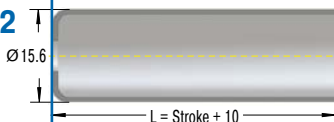
**Swivel Eye E3,5**  
max. force 370 N

**G3,5**

**Ball Socket G3,5**  
max. force 370 N

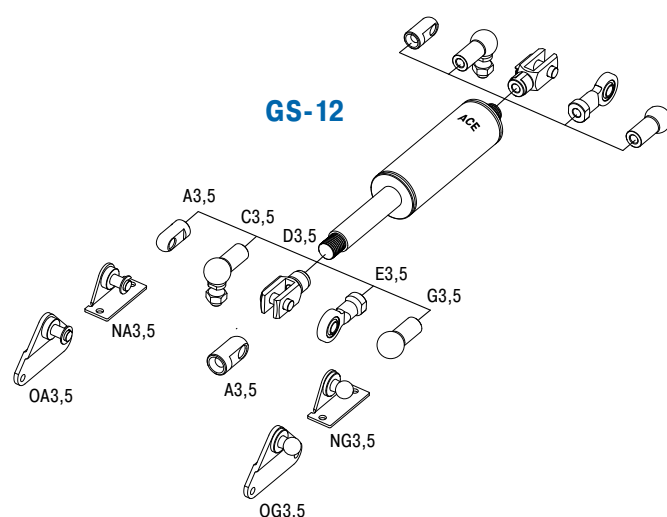
**Rod Shroud W3,5-12**

Mounting accessories see from page 200.

**Adjuster Knob DE-GAS-3,5**  
See page 175.

**Technical Data**
**Extension force:** 15 N to 180 N (compressed up to 243 N)

**Progression:** Approx. 20 % to 35 %

**Operating temperature range:** -20 °C to +80 °C

**Material:** Outer body: coated steel; Piston rod: stainless steel (1.4301/1.4305, AISI 304/303); End fittings: zinc plated steel

**Mounting:** We recommend mounting with piston rod downwards to take advantage of the built-in end position damping.

**End position damping length:** approx. 10 mm (depending on the stroke)

**Positive stop:** External positive stop at the end of stroke provided by the customer.

**Note:** Increased break-away force if unit has not moved for some time.

**End fittings:** They are interchangeable and if necessary must be positively secured by the customer to prevent unscrewing.

**Safety instructions:** Gas springs (push type) should not be installed under pre-tension.

Valve Technology, Extension force 40 N to 400 N (compressed up to 560 N)

**End Fitting**

**Standard Dimensions**

**End Fitting**

**A5**

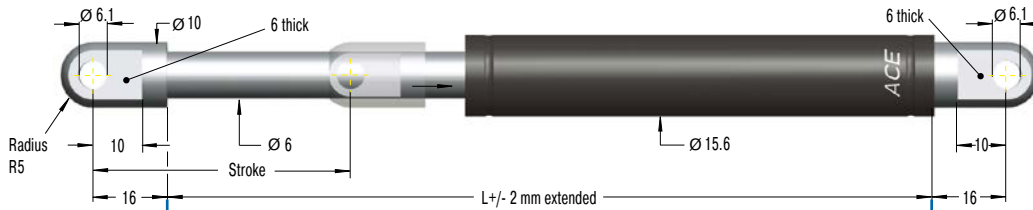

**Eye A5**  
max. force 800 N

**B5**

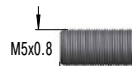

**Stud Thread B5**

**C5**

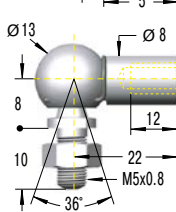

**Angle Ball Joint C5**  
max. force 500 N

**D5**

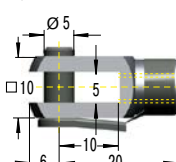

**Clevis Fork D5**  
max. force 800 N

**E5**

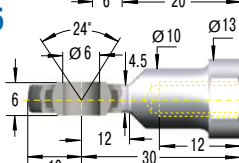

**Swivel Eye E5**  
max. force 800 N

**F5**

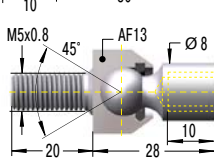

**Inline Ball Joint F5**  
max. force 500 N

**G5**

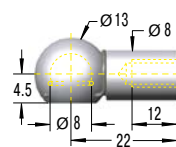

**Ball Socket G5**  
max. force 500 N

**Rod Shroud W5-15**

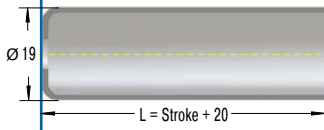

**Performance and Dimensions**

| TYPES     | Stroke mm | L extended mm | Extension force max. N |
|-----------|-----------|---------------|------------------------|
| GS-15-20  | 20        | 67            | 400                    |
| GS-15-40  | 40        | 107           | 400                    |
| GS-15-50  | 50        | 127           | 400                    |
| GS-15-60  | 60        | 147           | 400                    |
| GS-15-80  | 80        | 187           | 400                    |
| GS-15-100 | 100       | 227           | 400                    |
| GS-15-120 | 120       | 267           | 400                    |
| GS-15-150 | 150       | 327           | 400                    |
| GS-15-200 | 200       | 427           | 350                    |

**Ordering Example**

**GS-15-150-AC-150**

Type (Push Type) \_\_\_\_\_  
 Body Ø (15.6 mm) \_\_\_\_\_  
 Stroke (150 mm) \_\_\_\_\_  
 Piston Rod End Fitting A5 \_\_\_\_\_  
 Body End Fitting C5 \_\_\_\_\_  
 Nominal Force F<sub>1</sub> 150 N \_\_\_\_\_

Mounting accessories see from page 200.

**Adjuster Knob DE-GAS-5**  
See page 175.

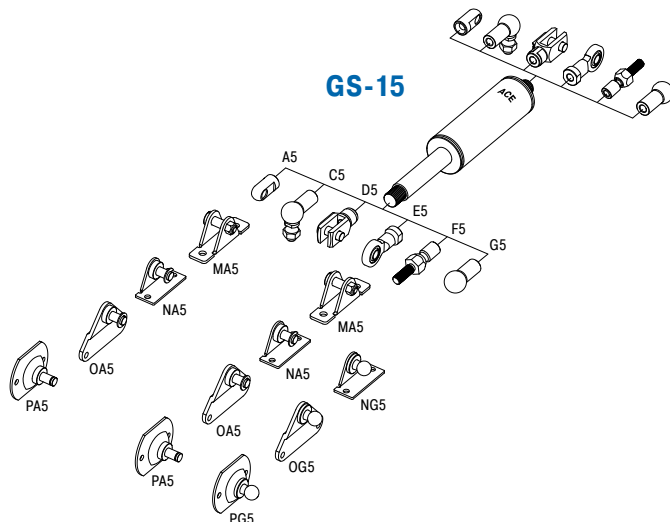

**Technical Data**

**Extension force:** 40 N to 400 N (compressed up to 560 N)

**Progression:** Approx. 30 % to 40 %

**Operating temperature range:** -20 °C to +80 °C

**Material:** Outer body: steel coated with UV paint; Piston rod: steel with wear-resistant coating; End fittings: zinc plated steel

**Mounting:** We recommend mounting with piston rod downwards to take advantage of the built-in end position damping.

**End position damping length:** approx. 10 mm (depending on the stroke)

**Positive stop:** External positive stop at the end of stroke provided by the customer.

**Note:** Increased break-away force if unit has not moved for some time.

**End fittings:** They are interchangeable and if necessary must be positively secured by the customer to prevent unscrewing.

**Safety instructions:** Gas springs (push type) should not be installed under pre-tension.

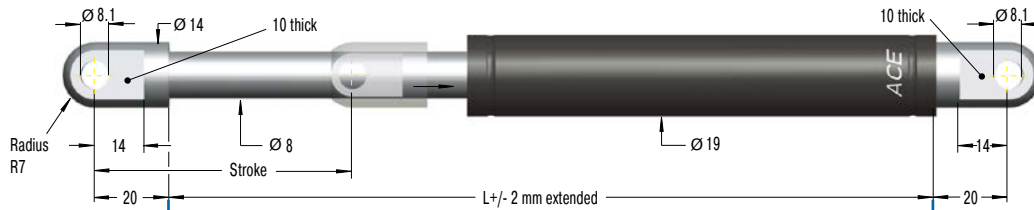

Valve Technology, Extension force 50 N to 700 N (compressed up to 945 N)

**End Fitting**
**Standard Dimensions**
**End Fitting**
**A8**

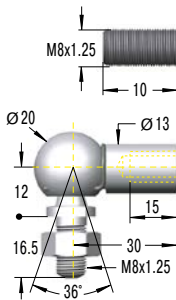
**Eye A8**  
max. force 3,000 N

**B8**
**C8**

**Performance and Dimensions**

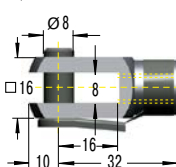
| TYPES     | Stroke mm | L extended mm | Extension force max. N |
|-----------|-----------|---------------|------------------------|
| GS-19-50  | 50        | 164           | 700                    |
| GS-19-100 | 100       | 264           | 700                    |
| GS-19-150 | 150       | 364           | 700                    |
| GS-19-200 | 200       | 464           | 700                    |
| GS-19-250 | 250       | 564           | 600                    |
| GS-19-300 | 300       | 664           | 450                    |

**Stud Thread B8**
**Angle Ball Joint C8**  
max. force 1,200 N

**D8**

**Ordering Example**
**GS-19-150-AC-600**

Type (Push Type) \_\_\_\_\_  
 Body Ø (19 mm) \_\_\_\_\_  
 Stroke (150 mm) \_\_\_\_\_  
 Piston Rod End Fitting A8 \_\_\_\_\_  
 Body End Fitting C8 \_\_\_\_\_  
 Nominal Force F<sub>1</sub> 600 N \_\_\_\_\_

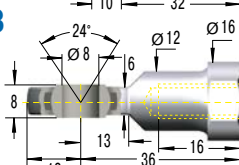
**Clevis Fork D8**  
max. force 3,000 N

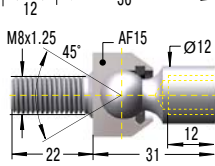
**E8**

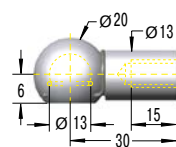
**Swivel Eye E8**  
max. force 3,000 N

**F8**

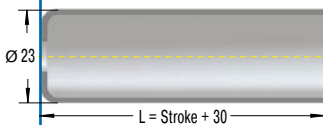
**Inline Ball Joint F8**  
max. force 1,200 N

**G8**

**Ball Socket G8**  
max. force 1,200 N

**Rod Shroud W8-19**

Mounting accessories see from page 200.

**Adjuster Knob DE-GAS-8**  
See page 175.

**Technical Data**
**Extension force:** 50 N to 700 N (compressed up to 945 N)

**Progression:** Approx. 24 % to 35 %

**Operating temperature range:** -20 °C to +80 °C

**Material:** Outer body: steel coated with UV paint; Piston rod: steel with wear-resistant coating; End fittings: zinc plated steel

**Mounting:** In any position. Hint: We recommend mounting with piston rod downwards to take advantage of the built-in end position damping.

**End position damping length:** approx. 20 mm to 60 mm (depending on the stroke)

**Positive stop:** External positive stop at the end of stroke provided by the customer.

**Note:** Integrated grease chamber reduces friction and wear and optimises lubrication.

**End fittings:** They are interchangeable and if necessary must be positively secured by the customer to prevent unscrewing.

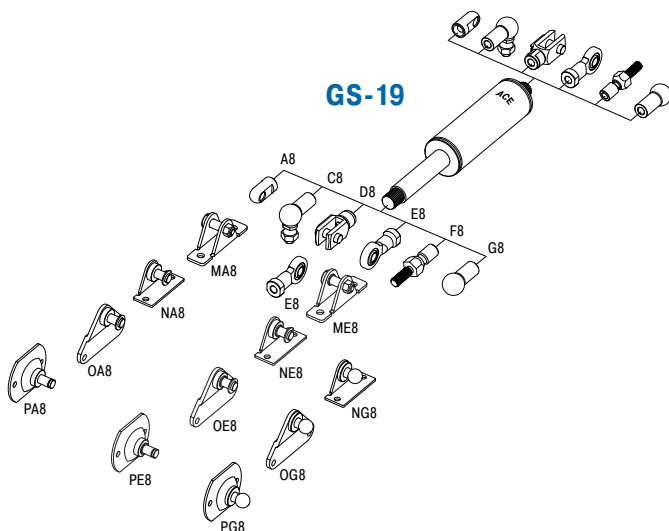
**Safety instructions:** Gas springs (push type) should not be installed under pre-tension.



Valve Technology, Extension force 80 N to 1,300 N (compressed up to 1,820 N)

End Fitting

Standard Dimensions

End Fitting

A8

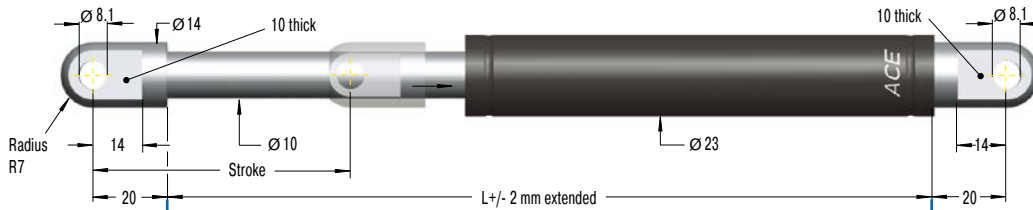

Eye A8  
max. force 3,000 N

B8



Stud Thread B8

C8

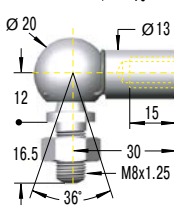

Angle Ball Joint C8  
max. force 1,200 N

D8

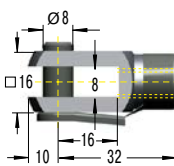

Clevis Fork D8  
max. force 3,000 N

E8

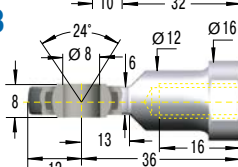

Swivel Eye E8  
max. force 3,000 N

F8

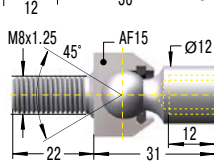

Inline Ball Joint F8  
max. force 1,200 N

G8

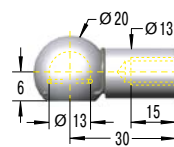

Ball Socket G8  
max. force 1,200 N

Rod Shroud W8-22

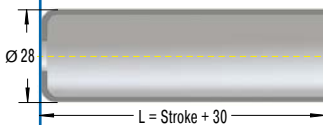

Performance and Dimensions

| TYPES     | Stroke mm | L extended mm | Extension force max. N |
|-----------|-----------|---------------|------------------------|
| GS-22-50  | 50        | 164           | 1,300                  |
| GS-22-100 | 100       | 264           | 1,300                  |
| GS-22-150 | 150       | 364           | 1,300                  |
| GS-22-200 | 200       | 464           | 1,300                  |
| GS-22-250 | 250       | 564           | 1,300                  |
| GS-22-300 | 300       | 664           | 1,100                  |
| GS-22-350 | 350       | 764           | 850                    |
| GS-22-400 | 400       | 864           | 650                    |
| GS-22-450 | 450       | 964           | 550                    |
| GS-22-500 | 500       | 1,064         | 450                    |
| GS-22-550 | 550       | 1,164         | 400                    |
| GS-22-600 | 600       | 1,264         | 350                    |
| GS-22-650 | 650       | 1,364         | 300                    |
| GS-22-700 | 700       | 1,464         | 250                    |

Ordering Example

GS-22-150-AE-800

Type (Push Type) \_\_\_\_\_  
 Body Ø (23 mm) \_\_\_\_\_  
 Stroke (150 mm) \_\_\_\_\_  
 Piston Rod End Fitting A8 \_\_\_\_\_  
 Body End Fitting E8 \_\_\_\_\_  
 Nominal Force F<sub>1</sub> 800 N \_\_\_\_\_

Mounting accessories see from page 200.

Adjuster Knob  
DE-GAS-8  
See page 175.

Technical Data

Extension force: 80 N to 1,300 N (compressed up to 1,820 N)

Progression: Approx. 30 % to 40 %

Operating temperature range: -20 °C to +80 °C

Material: Outer body: steel coated with UV paint; Piston rod: steel with wear-resistant coating; End fittings: zinc plated steel

Mounting: In any position. Hint: We recommend mounting with piston rod downwards to take advantage of the built-in end position damping.

End position damping length: approx. 20 mm to 70 mm (depending on the stroke)

Positive stop: External positive stop at the end of stroke provided by the customer.

Note: Integrated grease chamber reduces friction and wear and optimises lubrication.

End fittings: They are interchangeable and if necessary must be positively secured by the customer to prevent unscrewing.

Safety instructions: Gas springs (push type) should not be installed under pre-tension.

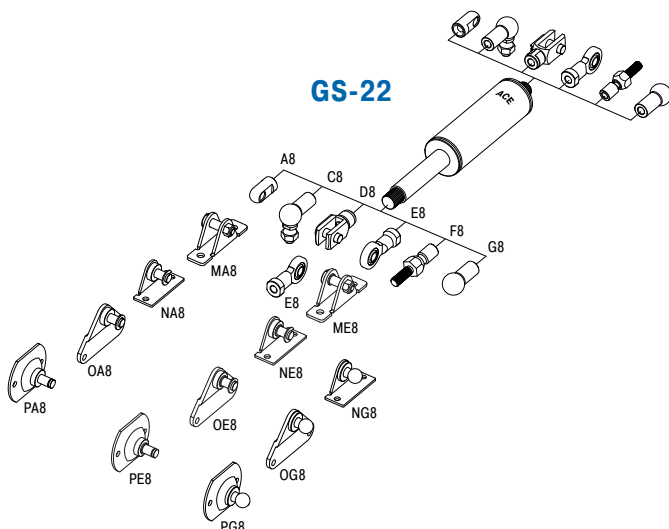

Valve Technology, Extension force 150 N to 2,500 N (compressed up to 4,400 N)

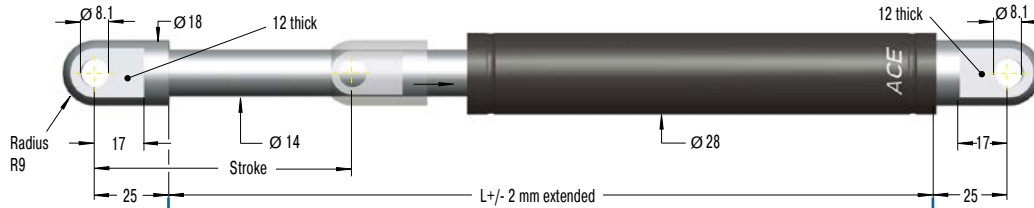
**End Fitting**
**Standard Dimensions**
**End Fitting**
**A10**

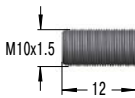
**Eye A10**  
max. force 10,000 N

**B10**

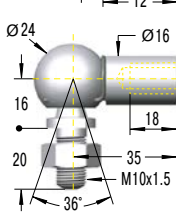
**Performance and Dimensions**

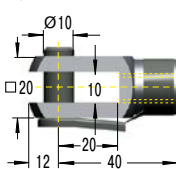
| TYPES     | Stroke<br>mm | L extended<br>mm | Extension force max.<br>N |
|-----------|--------------|------------------|---------------------------|
| GS-28-100 | 100          | 262              | 2,500                     |
| GS-28-150 | 150          | 362              | 2,500                     |
| GS-28-200 | 200          | 462              | 2,500                     |
| GS-28-250 | 250          | 562              | 2,500                     |
| GS-28-300 | 300          | 662              | 2,500                     |
| GS-28-350 | 350          | 762              | 2,500                     |
| GS-28-400 | 400          | 862              | 2,400                     |
| GS-28-450 | 450          | 962              | 1,950                     |
| GS-28-500 | 500          | 1,062            | 1,600                     |
| GS-28-550 | 550          | 1,162            | 1,350                     |
| GS-28-600 | 600          | 1,262            | 1,150                     |
| GS-28-650 | 650          | 1,362            | 1,000                     |
| GS-28-700 | 700          | 1,462            | 900                       |
| GS-28-750 | 750          | 1,562            | 800                       |

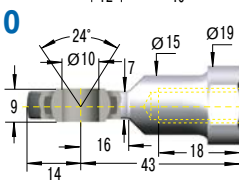
**Stud Thread B10**
**C10**

**Angle Ball Joint C10**  
max. force 1,800 N

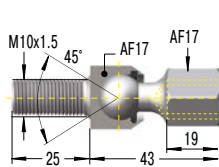
**D10**

**Clevis Fork D10**  
max. force 10,000 N

**E10**

**Swivel Eye E10**  
max. force 10,000 N

**F10**

**Inline Ball Joint F10**  
max. force 1,800 N

**Ordering Example**
**GS-28-150-EE-1200**

Type (Push Type) \_\_\_\_\_  
 Body Ø (28 mm) \_\_\_\_\_  
 Stroke (150 mm) \_\_\_\_\_  
 Piston Rod End Fitting E10 \_\_\_\_\_  
 Body End Fitting E10 \_\_\_\_\_  
 Nominal Force F<sub>1</sub> 1200 N \_\_\_\_\_

Mounting accessories see from page 200.

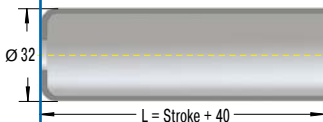
**Adjuster Knob  
DE-GAS-10**  
See page 175.

**Rod Shroud W10-28**

**Technical Data**
**Extension force:** 150 N to 2,500 N (compressed up to 4,400 N)

**Progression:** Approx. 63 % to 76 %

**Operating temperature range:** -20 °C to +80 °C

**Material:** Outer body: steel coated with UV paint; Piston rod: steel with wear-resistant coating; End fittings: zinc plated steel

**Mounting:** In any position. Hint: We recommend mounting with piston rod downwards to take advantage of the built-in end position damping.

**End position damping length:** approx. 30 mm to 70 mm (depending on the stroke)

**Positive stop:** External positive stop at the end of stroke provided by the customer.

**Note:** Integrated grease chamber reduces friction and wear and optimises lubrication.

**End fittings:** They are interchangeable and if necessary must be positively secured by the customer to prevent unscrewing.

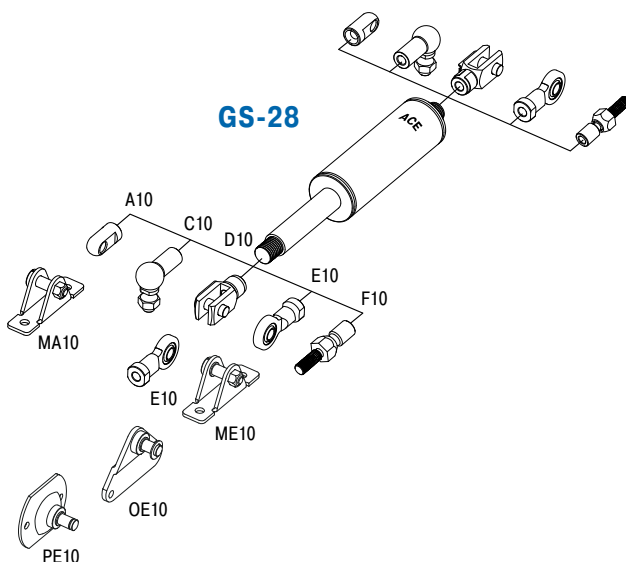
**Safety instructions:** Gas springs (push type) should not be installed under pre-tension.

Valve Technology, Extension force 500 N to 5,000 N (compressed up to 7,500 N)

**End Fitting**

**Standard Dimensions**

**End Fitting**

**A14**

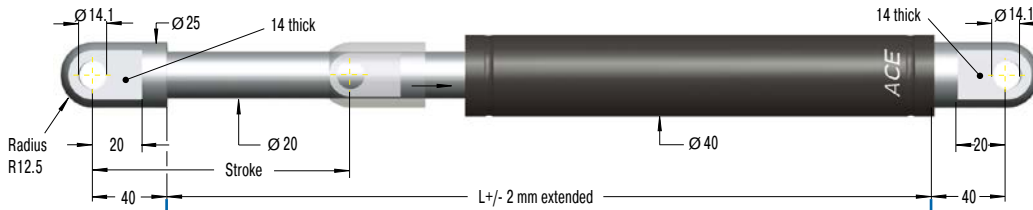

**Eye A14**  
max. force 10,000 N

**B14**

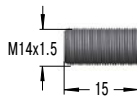

**Stud Thread B14**

**C14**

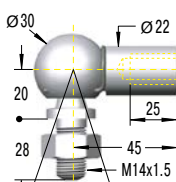

**Angle Ball Joint C14**  
max. force 3,200 N

**D14**

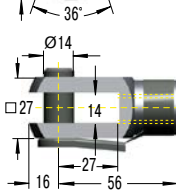

**Clevis Fork D14**  
max. force 10,000 N

**E14**

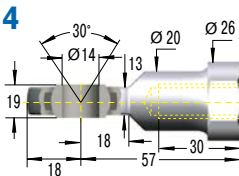

**Swivel Eye E14**  
max. force 10,000 N

**F14**

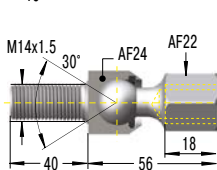

**Inline Ball Joint F14**  
max. force 3,200 N

**Rod Shroud W14-40**

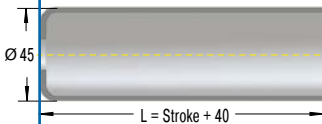

**Performance and Dimensions**

| TYPES      | Stroke mm | L extended mm | Extension force max. N |
|------------|-----------|---------------|------------------------|
| GS-40-100  | 100       | 317           | 5,000                  |
| GS-40-150  | 150       | 417           | 5,000                  |
| GS-40-200  | 200       | 517           | 5,000                  |
| GS-40-250  | 250       | 617           | 5,000                  |
| GS-40-300  | 300       | 717           | 5,000                  |
| GS-40-400  | 400       | 917           | 5,000                  |
| GS-40-500  | 500       | 1,117         | 5,000                  |
| GS-40-600  | 600       | 1,317         | 4,150                  |
| GS-40-800  | 800       | 1,717         | 2,550                  |
| GS-40-1000 | 1,000     | 2,117         | 1,700                  |

**Ordering Example**

**GS-40-150-DD-3500**

Type (Push Type) \_\_\_\_\_  
 Body Ø (40 mm) \_\_\_\_\_  
 Stroke (150 mm) \_\_\_\_\_  
 Piston Rod End Fitting D14 \_\_\_\_\_  
 Body End Fitting D14 \_\_\_\_\_  
 Nominal Force  $F_1$  3500 N \_\_\_\_\_

Mounting accessories see from page 200.

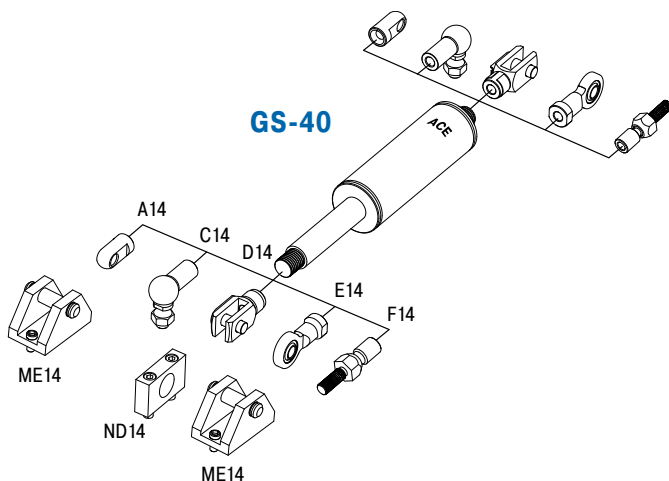

**Technical Data**

**Extension force:** 500 N to 5,000 N (compressed up to 7,500 N)

**Progression:** Approx. 38 % to 50 %

**Operating temperature range:** -20 °C to +80 °C

**Material:** Outer body: steel coated with UV paint; Piston rod: steel with wear-resistant coating; End fittings: zinc plated steel

**Mounting:** In any position. Hint: We recommend mounting with piston rod downwards to take advantage of the built-in end position damping.

**End position damping length:** approx. 30 mm to 70 mm (depending on the stroke)

**Positive stop:** External positive stop at the end of stroke provided by the customer.

**Note:** Integrated grease chamber reduces friction and wear and optimises lubrication.

**End fittings:** They are interchangeable and if necessary must be positively secured by the customer to prevent unscrewing.

**Safety instructions:** Gas springs (push type) should not be installed under pre-tension.

**Adjuster Knob DE-GAS-14**

See page 175.

Valve Technology, Extension force 2,000 N to 13,000 N (compressed up to 16,250 N)

### End Fitting

### Standard Dimensions

### End Fitting

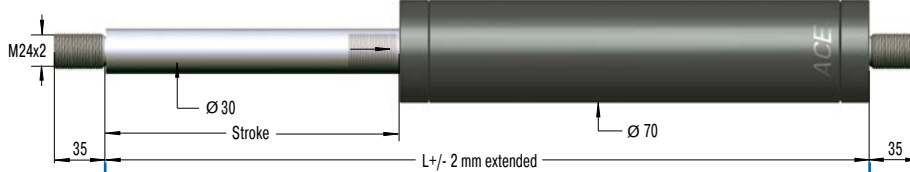
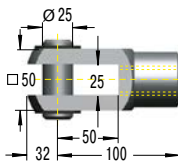
**B24**

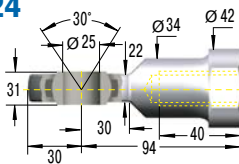
**Stud Thread B24**
**D24**

**Clevis Fork D24**  
max. force 50,000 N

**E24**

**Swivel Eye E24**  
max. force 50,000 N

#### Performance and Dimensions

| TYPES     | Stroke<br>mm | L extended<br>mm | Extension force max.<br>N |
|-----------|--------------|------------------|---------------------------|
| GS-70-100 | 100          | 320              | 13,000                    |
| GS-70-200 | 200          | 520              | 13,000                    |
| GS-70-300 | 300          | 720              | 13,000                    |
| GS-70-400 | 400          | 920              | 13,000                    |
| GS-70-500 | 500          | 1,120            | 13,000                    |
| GS-70-600 | 600          | 1,320            | 13,000                    |
| GS-70-700 | 700          | 1,520            | 13,000                    |
| GS-70-800 | 800          | 1,720            | 11,550                    |

#### Ordering Example

**GS-70-200-EE-8000**

Type (Push Type) \_\_\_\_\_  
 Body Ø (70 mm) \_\_\_\_\_  
 Stroke (200 mm) \_\_\_\_\_  
 Piston Rod End Fitting E24 \_\_\_\_\_  
 Body End Fitting E24 \_\_\_\_\_  
 Nominal Force F<sub>1</sub> 8000 N \_\_\_\_\_

Mounting accessories see from page 200.

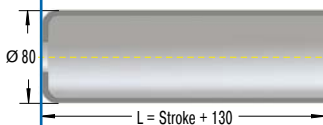
**Rod Shroud W24-70**

### Technical Data

**Extension force:** 2,000 N to 13,000 N (compressed up to 16,250 N)

**Progression:** Approx. 25 %

**Operating temperature range:** -20 °C to +80 °C

**Material:** Outer body: coated steel; Piston rod: hard chrome plated steel; End fittings: zinc plated steel

**Mounting:** In any position. Hint: We recommend mounting with piston rod downwards to take advantage of the built-in end position damping.

**End position damping length:** approx. 10 mm to 20 mm (depending on the stroke)

**Positive stop:** External positive stop at the end of stroke provided by the customer.

**Note:** Increased break-away force if unit has not moved for some time.

**End fittings:** They are interchangeable and if necessary must be positively secured by the customer to prevent unscrewing.

**Safety instructions:** Gas springs (push type) should not be installed under pre-tension.

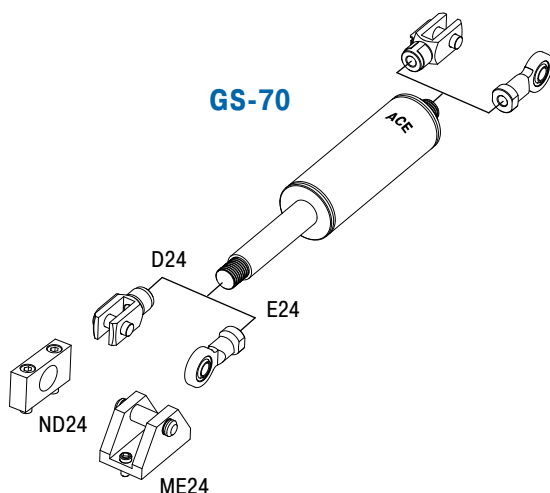

## GS-8-V4A to GS-40-VA

With food grade oil according to FDA approval

### Valve Technology, Stainless Steel

Force range 10 N to 5,000 N

Stroke 20 mm to 700 mm

Protection against corrosion and superior optics for even more sophisticated requirements: Based on ACE's industrial gas push type springs GS-8 to 40 made of steel, these models combine all advantages of stainless steel: they look great and are rust free. They are filled with food-grade oil as standard, which conforms to the requirements of FDA 21 CFR 178.3570.

These ACE gas push type springs do not only look good, they also are available in various stroke lengths and possible extension forces. A comprehensive range of accessories in stainless steel guarantees easy assembly and a broad range of uses.

ACE industrial gas pressure springs made of stainless steel are used in the automotive sector, in industrial applications, mechanical engineering and medical cleanroom technology as well as in the food, electronics and shipbuilding industries.

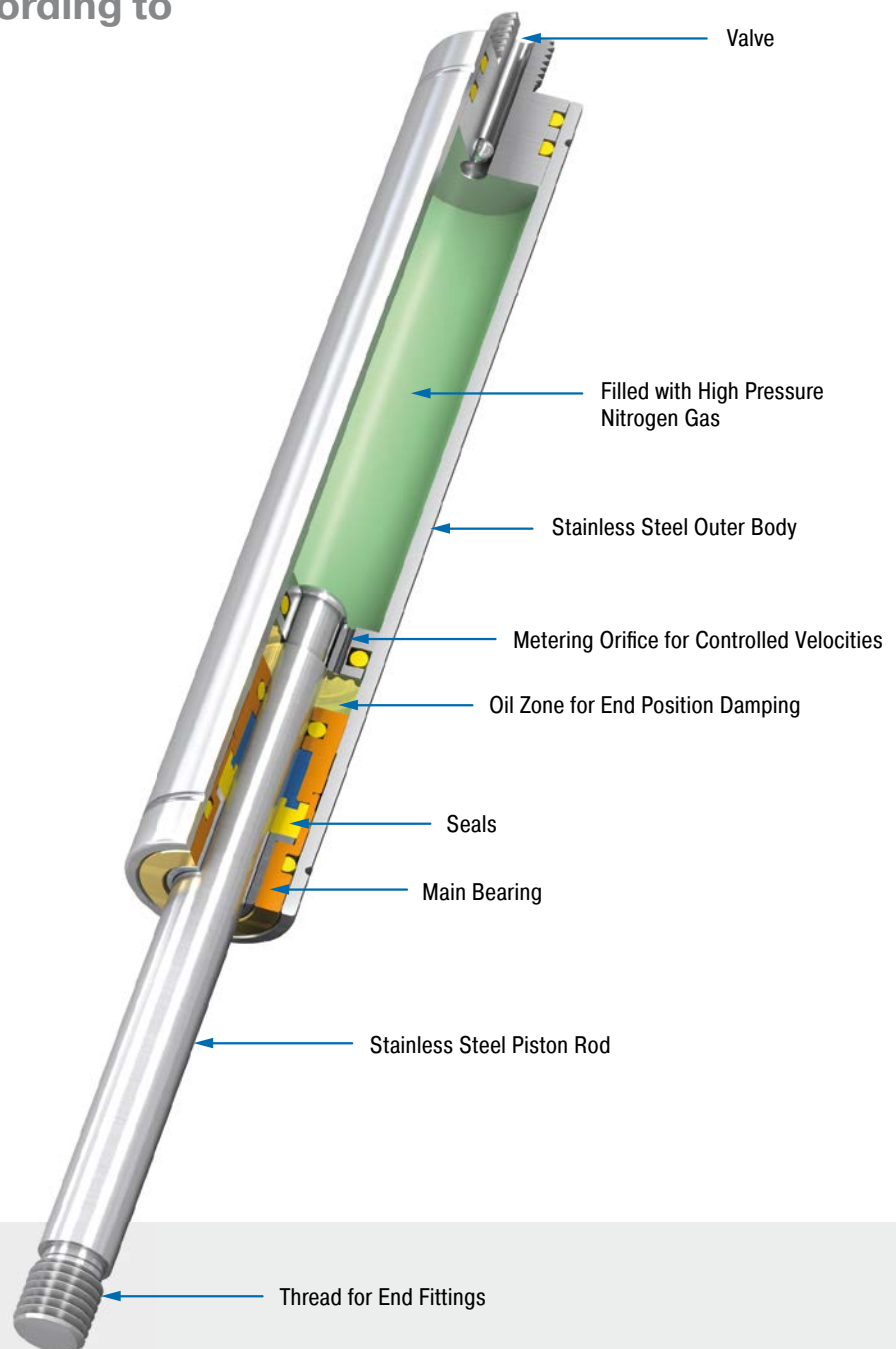

### Technical Data

**Extension force:** 10 N to 5,000 N

**Piston rod diameter:** Ø 3 mm to Ø 20 mm

**Progression:** approx. 13 % to 59 % (depending on size and stroke)

**Lifetime:** Approx. 10.000 m

**Operating temperature range:** -20 °C to +80 °C

**Material:** Outer body, Piston rod, End fittings: stainless steel (1.4301/1.4305, AISI 304/303 and 1.4404/1.4571, AISI 316L/316Ti)

**Operating fluid:** nitrogen gas and HLP oil according to DIN 51524, part 2

**Mounting:** We recommend mounting with piston rod downwards to take advantage of the built-in end position damping.

**End position damping length:** Approx. 5 mm to 30 mm (depending on the stroke)

**Positive stop:** External positive stop at the end of stroke provided by the customer.

**Application field:** hoods, shutters, machine housing, conveyor systems, control boxes, furniture industry, shipbuilding, food industry, pharmaceutical industry, folding elements

**Note:** Special oil according to FDA 21 CFR 178.3570 of the food industry

**End fittings:** They are interchangeable and if necessary must be positively secured by the customer to prevent unscrewing.

**Safety instructions:** Gas pressure springs should not be installed under pre-tension.

**On request:** Special oils and other special options. Alternative accessories. Different end position damping and extension speed. Other gas springs material 1.4404/1.4571, AISI 316L/316Ti (V4A) available on request.



Valve Technology, Stainless Steel, Extension force 10 N to 100 N (compressed up to 131 N)

**End Fitting**
**Standard Dimensions**
**End Fitting**

**B3,5**

**A3,5-V4A**

**C3,5-V4A**

**D3,5-V4A**

**G3,5-V4A**

**Stud Thread B3,5**

**Eye A3,5-V4A**  
max. force 370 N

**Angle Ball Joint C3,5-V4A**  
max. force 370 N

**Clevis Fork D3,5-V4A**  
max. force 370 N

**Ball Socket G3,5-V4A**  
max. force 370 N

**Adjuster Knob DE-GAS-3,5**  
See page 175.

| Performance and Dimensions |              |                  |                           |
|----------------------------|--------------|------------------|---------------------------|
| TYPES                      | Stroke<br>mm | L extended<br>mm | Extension force max.<br>N |
| GS-8-20-V4A                | 20           | 72               | 100                       |
| GS-8-30-V4A                | 30           | 92               | 100                       |
| GS-8-40-V4A                | 40           | 112              | 100                       |
| GS-8-50-V4A                | 50           | 132              | 100                       |
| GS-8-60-V4A                | 60           | 152              | 100                       |
| GS-8-80-V4A                | 80           | 192              | 100                       |

**Ordering Example** **GS-8-30-AC-30-V4A**

Type (Push Type) \_\_\_\_\_

Body Ø (8 mm) \_\_\_\_\_

Stroke (30 mm) \_\_\_\_\_

Piston Rod End Fitting A3,5-V4A \_\_\_\_\_

Body End Fitting C3,5-V4A \_\_\_\_\_

Nominal Force  $F_1$  30 N \_\_\_\_\_

Material (1.4404/1.4571, AISI 316L/316Ti, V4A) \_\_\_\_\_

**Mounting accessories see from page 208.**

**Technical Data**
**Extension force:** 10 N to 100 N (compressed up to 131 N)

**Progression:** Approx. 28 % to 31 %

**Operating temperature range:** -20 °C to +80 °C

**Material:** Outer body, Piston rod, End fittings: stainless steel (1.4404/1.4571, AISI 316L/316Ti)

**Mounting:** We recommend mounting with piston rod downwards to take advantage of the built-in end position damping.

**End position damping length:** approx. 5 mm (depending on the stroke)

**Positive stop:** External positive stop at the end of stroke provided by the customer.

**Note:** Special oil according to FDA 21 CFR 178.3570 of the food industry

**End fittings:** They are interchangeable and if necessary must be positively secured by the customer to prevent unscrewing.

**Safety instructions:** Gas pressure springs should not be installed under pre-tension.

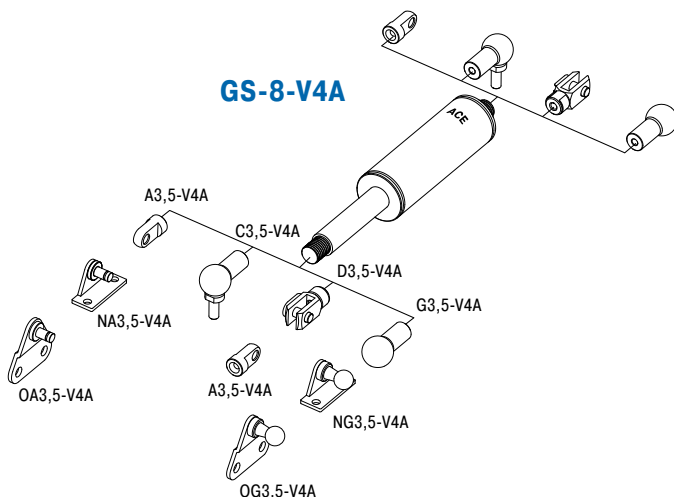
**GS-8-V4A**



Valve Technology, Stainless Steel, Extension force 10 N to 100 N (compressed up to 116 N)

End Fitting

Standard Dimensions

End Fitting

**B3,5**

**A3,5-V4A**

**C3,5-V4A**

**D3,5-V4A**

**G3,5-V4A**

**Performance and Dimensions**

| TYPES        | Stroke<br>mm | L extended<br>mm | Extension force max.<br>N |
|--------------|--------------|------------------|---------------------------|
| GS-10-20-V4A | 20           | 72               | 100                       |
| GS-10-30-V4A | 30           | 92               | 100                       |
| GS-10-40-V4A | 40           | 112              | 100                       |
| GS-10-50-V4A | 50           | 132              | 100                       |
| GS-10-60-V4A | 60           | 152              | 100                       |
| GS-10-80-V4A | 80           | 192              | 100                       |

**Ordering Example**

**GS-10-30-AC-30-V4A**

Type (Push Type) \_\_\_\_\_

Body Ø (10 mm) \_\_\_\_\_

Stroke (30 mm) \_\_\_\_\_

Piston Rod End Fitting A3,5-V4A \_\_\_\_\_

Body End Fitting C3,5-V4A \_\_\_\_\_

Nominal Force F<sub>1</sub> 30 N \_\_\_\_\_

Material (1.4404/1.4571, AISI 316L/316Ti, V4A) \_\_\_\_\_

**Stud Thread B3,5**

**Eye A3,5-V4A**  
max. force 370 N

**Angle Ball Joint C3,5-V4A**  
max. force 370 N

**Clevis Fork D3,5-V4A**  
max. force 370 N

**Ball Socket G3,5-V4A**  
max. force 370 N

**Adjuster Knob DE-GAS-3,5**  
See page 175.

**Mounting accessories see from page 208.**

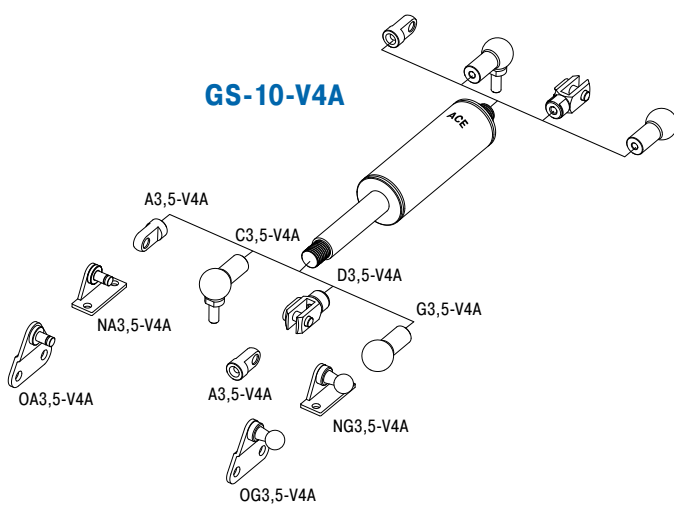

**Technical Data**

- Extension force:** 10 N to 100 N (compressed up to 116 N)
- Progression:** Approx. 13 % to 16 %
- Operating temperature range:** -20 °C to +80 °C
- Material:** Outer body, Piston rod, End fittings: stainless steel (1.4404/1.4571, AISI 316L/316Ti)
- Mounting:** We recommend mounting with piston rod downwards to take advantage of the built-in end position damping.
- End position damping length:** approx. 5 mm (depending on the stroke)
- Positive stop:** External positive stop at the end of stroke provided by the customer.
- Note:** Special oil according to FDA 21 CFR 178.3570 of the food industry
- End fittings:** They are interchangeable and if necessary must be positively secured by the customer to prevent unscrewing.
- Safety instructions:** Gas pressure springs should not be installed under pre-tension.

Issue 07.2017 – Specifications subject to change

Valve Technology, Stainless Steel, Extension force 15 N to 180 N (compressed up to 225 N)

### End Fitting

### Standard Dimensions

### End Fitting

**B3,5**

**A3,5-V4A**

**C3,5-V4A**

**D3,5-V4A**

**G3,5-V4A**

**Performance and Dimensions**

| TYPES         | Stroke<br>mm | L extended<br>mm | Extension force max.<br>N |
|---------------|--------------|------------------|---------------------------|
| GS-12-20-V4A  | 20           | 72               | 180                       |
| GS-12-30-V4A  | 30           | 92               | 180                       |
| GS-12-40-V4A  | 40           | 112              | 180                       |
| GS-12-50-V4A  | 50           | 132              | 180                       |
| GS-12-60-V4A  | 60           | 152              | 180                       |
| GS-12-80-V4A  | 80           | 192              | 150                       |
| GS-12-100-V4A | 100          | 232              | 150                       |
| GS-12-120-V4A | 120          | 272              | 120                       |
| GS-12-150-V4A | 150          | 332              | 100                       |

**Ordering Example**

GS-12-100-AA-30-V4A

Type (Push Type) \_\_\_\_\_

Body Ø (12 mm) \_\_\_\_\_

Stroke (100 mm) \_\_\_\_\_

Piston Rod End Fitting A3,5-V4A \_\_\_\_\_

Body End Fitting A3,5-V4A \_\_\_\_\_

Nominal Force F<sub>1</sub> 30 N \_\_\_\_\_

Material (1.4404/1.4571, AISI 316L/316Ti, V4A) \_\_\_\_\_

**Stud Thread B3,5**

**Eye A3,5-V4A**  
max. force 370 N

**Angle Ball Joint C3,5-V4A**  
max. force 370 N

**Clevis Fork D3,5-V4A**  
max. force 370 N

**Ball Socket G3,5-V4A**  
max. force 370 N

**Adjuster Knob DE-GAS-3,5**  
See page 175.

Mounting accessories see from page 208.

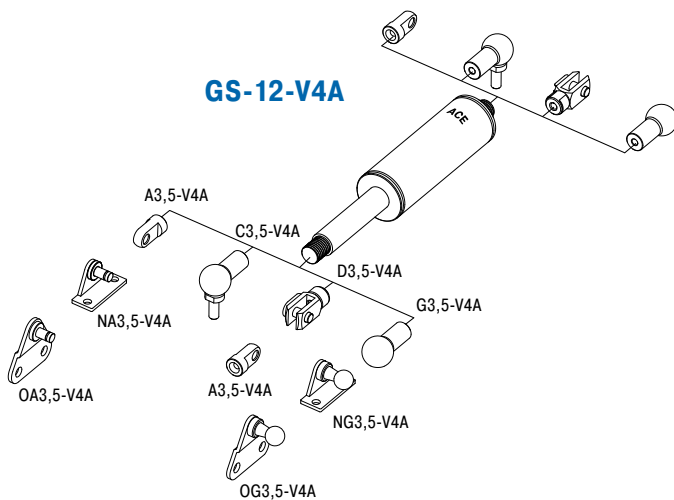

### Technical Data

**Extension force:** 15 N to 180 N (compressed up to 225 N)

**Progression:** Approx. 20 % to 25 %

**Operating temperature range:** -20 °C to +80 °C

**Material:** Outer body, Piston rod, End fittings: stainless steel (1.4404/1.4571, AISI 316L/316Ti)

**Mounting:** We recommend mounting with piston rod downwards to take advantage of the built-in end position damping.

**End position damping length:** approx. 10 mm (depending on the stroke)

**Positive stop:** External positive stop at the end of stroke provided by the customer.

**Note:** Special oil according to FDA 21 CFR 178.3570 of the food industry

**End fittings:** They are interchangeable and if necessary must be positively secured by the customer to prevent unscrewing.

**Safety instructions:** Gas pressure springs should not be installed under pre-tension.

Valve Technology, Stainless Steel, Extension force 40 N to 400 N (compressed up to 612 N)

End Fitting

Standard Dimensions

End Fitting

**Performance and Dimensions**

| TYPES        | Stroke mm | L extended mm | Extension force max. N |
|--------------|-----------|---------------|------------------------|
| GS-15-20-VA  | 20        | 74            | 400                    |
| GS-15-40-VA  | 40        | 114           | 400                    |
| GS-15-50-VA  | 50        | 134           | 400                    |
| GS-15-60-VA  | 60        | 154           | 400                    |
| GS-15-80-VA  | 80        | 194           | 400                    |
| GS-15-100-VA | 100       | 234           | 400                    |
| GS-15-120-VA | 120       | 274           | 400                    |
| GS-15-150-VA | 150       | 334           | 400                    |

**Ordering Example**

**GS-15-150-AC-150-VA**

- Type (Push Type)
- Body Ø (15.6 mm)
- Stroke (150 mm)
- Piston Rod End Fitting A5-VA
- Body End Fitting C5-VA
- Nominal Force F<sub>1</sub> 150 N
- Material (1.4301/1.4305, AISI 304/303, VA)

**Adjuster Knob DE-GAS-5**  
See page 175.

**Mounting accessories see from page 208.**

**End Fitting Options:**

- B5:** Stud Thread B5
- A5-VA:** Eye A5-VA max. force 490 N
- C5-VA:** Angle Ball Joint C5-VA max. force 430 N
- D5-VA:** Clevis Fork D5-VA max. force 490 N
- E5-VA:** Swivel Eye E5-VA max. force 490 N
- G5-VA:** Ball Socket G5-VA max. force 430 N
- W5-15-VA:** Rod Shroud

Technical Data

- Extension force:** 40 N to 400 N (compressed up to 612 N)
- Progression:** Approx. 30 % to 53 %
- Operating temperature range:** -20 °C to +80 °C
- Material:** Outer body, Piston rod, End fittings: stainless steel (1.4301/1.4305, AISI 304/303)
- Mounting:** We recommend mounting with piston rod downwards to take advantage of the built-in end position damping.
- End position damping length:** approx. 20 mm (depending on the stroke)
- Positive stop:** External positive stop at the end of stroke provided by the customer.
- Note:** Special oil according to FDA 21 CFR 178.3570 of the food industry
- End fittings:** They are interchangeable and if necessary must be positively secured by the customer to prevent unscrewing.
- Safety instructions:** Gas pressure springs should not be installed under pre-tension.

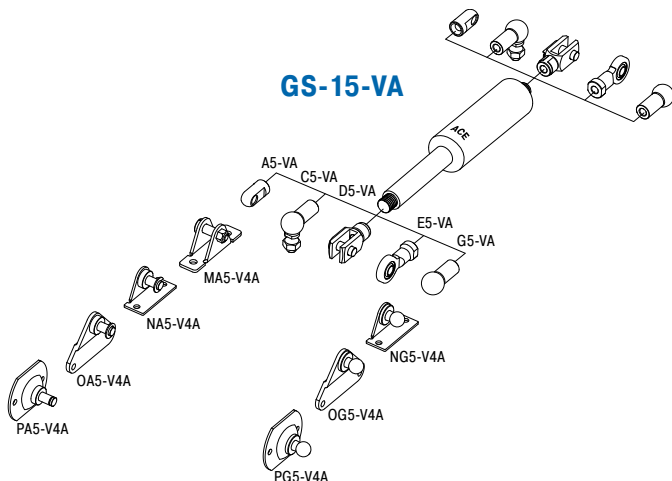

Issue 07.2017 – Specifications subject to change

Valve Technology, Stainless Steel, Extension force 50 N to 700 N (compressed up to 924 N)

**End Fitting**
**Standard Dimensions**
**End Fitting**

**B8**

M8x1.25

Ø 8

Stroke

Ø 19

10

L +/- 2 mm extended

**A8-VA**

Radius R7

8.1

Ø 14

11.5

10

19

**C8-VA**

Ø 20

Ø 13

12

15

16.5

30

M8x1.25

36°

**D8-VA**

Ø 8

22

16

8

16

32

**E8-VA**

24°

Ø 8

6

Ø 12

Ø 16

12

13

36

16

**G8-VA**

Ø 20

Ø 13

6

Ø 13

15

30

**Rod Shroud W8-19-VA**

Ø 23

L = Stroke + 30

**Performance and Dimensions**

| TYPES        | Stroke mm | L extended mm | Extension force max. N |
|--------------|-----------|---------------|------------------------|
| GS-19-50-VA  | 50        | 164           | 700                    |
| GS-19-100-VA | 100       | 264           | 700                    |
| GS-19-150-VA | 150       | 364           | 700                    |
| GS-19-200-VA | 200       | 464           | 700                    |
| GS-19-250-VA | 250       | 564           | 600                    |
| GS-19-300-VA | 300       | 664           | 450                    |

**Ordering Example**

**GS-19-150-AC-600-VA**

Type (Push Type) \_\_\_\_\_

Body Ø (19 mm) \_\_\_\_\_

Stroke (150 mm) \_\_\_\_\_

Piston Rod End Fitting A8-VA \_\_\_\_\_

Body End Fitting C8-VA \_\_\_\_\_

Nominal Force F<sub>1</sub> 600 N \_\_\_\_\_

Material (1.4301/1.4305, AISI 304/303, VA) \_\_\_\_\_

**Mounting accessories see from page 208.**

**Adjuster Knob DE-GAS-8**  
See page 175.

**Stud Thread B8**

**Eye A8-VA**  
max. force 1,560 N

**Angle Ball Joint C8-VA**  
max. force 1,140 N

**Clevis Fork D8-VA**  
max. force 1,560 N

**Swivel Eye E8-VA**  
max. force 1,560 N

**Ball Socket G8-VA**  
max. force 1,140 N

**Technical Data**
**Extension force:** 50 N to 700 N (compressed up to 924 N)

**Progression:** Approx. 28 % to 32 %

**Operating temperature range:** -20 °C to +80 °C

**Material:** Outer body, Piston rod, End fittings: stainless steel (1.4301/1.4305, AISI 304/303)

**Mounting:** We recommend mounting with piston rod downwards to take advantage of the built-in end position damping.

**End position damping length:** approx. 20 mm (depending on the stroke)

**Positive stop:** External positive stop at the end of stroke provided by the customer.

**Note:** Special oil according to FDA 21 CFR 178.3570 of the food industry

**End fittings:** They are interchangeable and if necessary must be positively secured by the customer to prevent unscrewing.

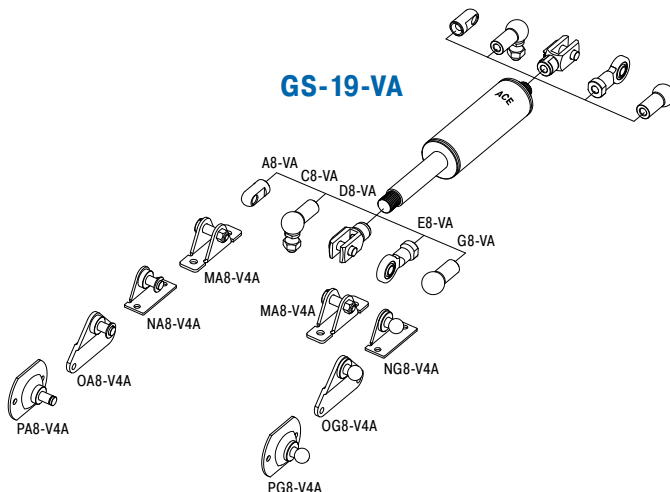
**Safety instructions:** Gas pressure springs should not be installed under pre-tension.

End Fitting

Standard Dimensions

End Fitting

**B8**

**A8-VA**

**C8-VA**

**D8-VA**

**E8-VA**

**G8-VA**

**Rod Shroud W8-22-VA**

**Performance and Dimensions**

| TYPES        | Stroke mm | L extended mm | Extension force max. N |
|--------------|-----------|---------------|------------------------|
| GS-22-50-VA  | 50        | 164           | 1,200                  |
| GS-22-100-VA | 100       | 264           | 1,200                  |
| GS-22-150-VA | 150       | 364           | 1,200                  |
| GS-22-200-VA | 200       | 464           | 1,200                  |
| GS-22-250-VA | 250       | 564           | 1,200                  |
| GS-22-300-VA | 300       | 664           | 1,100                  |
| GS-22-350-VA | 350       | 764           | 850                    |
| GS-22-400-VA | 400       | 864           | 650                    |
| GS-22-450-VA | 450       | 964           | 550                    |
| GS-22-500-VA | 500       | 1,064         | 450                    |
| GS-22-550-VA | 550       | 1,164         | 400                    |
| GS-22-600-VA | 600       | 1,264         | 350                    |
| GS-22-650-VA | 650       | 1,364         | 300                    |
| GS-22-700-VA | 700       | 1,464         | 250                    |

**Ordering Example**

Type (Push Type) \_\_\_\_\_

Body Ø (23 mm) \_\_\_\_\_

Stroke (150 mm) \_\_\_\_\_

Piston Rod End Fitting A8-VA \_\_\_\_\_

Body End Fitting E8-VA \_\_\_\_\_

Nominal Force  $F_1$  800 N \_\_\_\_\_

Material (1.4301/1.4305, AISI 304/303, VA) \_\_\_\_\_

**GS-22-150-AE-800-VA**

**Stud Thread B8**

**Eye A8-VA**  
max. force 1,560 N

**Angle Ball Joint C8-VA**  
max. force 1,140 N

**Clevis Fork D8-VA**  
max. force 1,560 N

**Swivel Eye E8-VA**  
max. force 1,560 N

**Ball Socket G8-VA**  
max. force 1,140 N

**Adjuster Knob DE-GAS-8**  
See page 175.

**Mounting accessories see from page 208.**

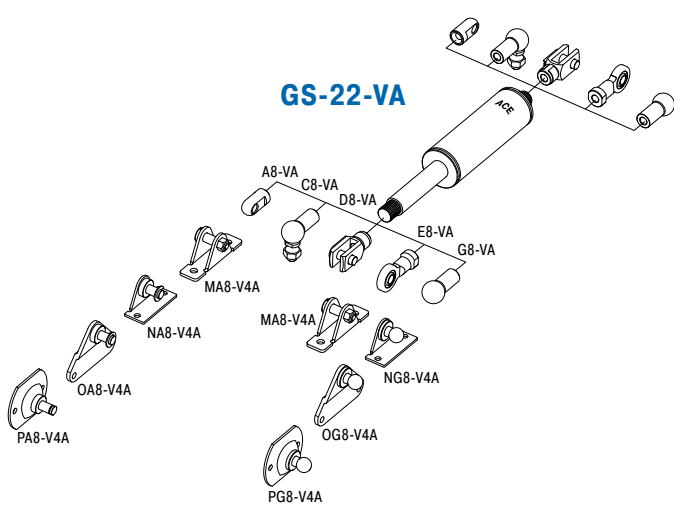

Technical Data

- Extension force:** 100 N to 1,200 N (compressed up to 1,596 N)
- Progression:** Approx. 29 % to 33 %
- Operating temperature range:** -20 °C to +80 °C
- Material:** Outer body, Piston rod, End fittings: stainless steel (1.4301/1.4305, AISI 304/303)
- Mounting:** We recommend mounting with piston rod downwards to take advantage of the built-in end position damping.
- End position damping length:** approx. 20 mm (depending on the stroke)
- Positive stop:** External positive stop at the end of stroke provided by the customer.
- Note:** Special oil according to FDA 21 CFR 178.3570 of the food industry
- End fittings:** They are interchangeable and if necessary must be positively secured by the customer to prevent unscrewing.
- Safety instructions:** Gas pressure springs should not be installed under pre-tension.

Issue 07.2017 – Specifications subject to change



Valve Technology, Stainless Steel, Extension force 150 N to 2,500 N (compressed up to 3,975 N)

### End Fitting

### Standard Dimensions

### End Fitting

**B10** Stud Thread B10

**A10-VA** Eye A10-VA max. force 3,800 N

**C10-VA** Angle Ball Joint C10-VA max. force 1,750 N

**D10-VA** Clevis Fork D10-VA max. force 3,800 N

**E10-VA** Swivel Eye E10-VA max. force 3,800 N

**Rod Shroud W10-28-VA** L = Stroke + 40

**Adjuster Knob DE-GAS-10** See page 175.

**Performance and Dimensions**

| TYPES        | Stroke mm | L extended mm | Extension force max. N |
|--------------|-----------|---------------|------------------------|
| GS-28-100-VA | 100       | 262           | 2,500                  |
| GS-28-150-VA | 150       | 362           | 2,500                  |
| GS-28-200-VA | 200       | 462           | 2,500                  |
| GS-28-250-VA | 250       | 562           | 2,500                  |
| GS-28-300-VA | 300       | 662           | 2,500                  |
| GS-28-350-VA | 350       | 762           | 2,500                  |
| GS-28-400-VA | 400       | 862           | 2,400                  |
| GS-28-450-VA | 450       | 962           | 1,950                  |
| GS-28-500-VA | 500       | 1,062         | 1,600                  |
| GS-28-550-VA | 550       | 1,162         | 1,350                  |
| GS-28-600-VA | 600       | 1,262         | 1,150                  |
| GS-28-650-VA | 650       | 1,362         | 1,000                  |

**Ordering Example**

**GS-28-150-EE-1200-VA**

Type (Push Type) \_\_\_\_\_

Body Ø (28 mm) \_\_\_\_\_

Stroke (150 mm) \_\_\_\_\_

Piston Rod End Fitting E10-VA \_\_\_\_\_

Body End Fitting E10-VA \_\_\_\_\_

Nominal Force F<sub>1</sub> 1200 N \_\_\_\_\_

Material (1.4301/1.4305, AISI 304/303, VA) \_\_\_\_\_

**Mounting accessories see from page 208.**

### Technical Data

**Extension force:** 150 N to 2,500 N (compressed up to 3,975 N)

**Progression:** Approx. 53 % to 59 %

**Operating temperature range:** -20 °C to +80 °C

**Material:** Outer body, Piston rod, End fittings: stainless steel (1.4301/1.4305, AISI 304/303)

**Mounting:** We recommend mounting with piston rod downwards to take advantage of the built-in end position damping.

**End position damping length:** approx. 20 mm (depending on the stroke)

**Positive stop:** External positive stop at the end of stroke provided by the customer.

**Note:** Special oil according to FDA 21 CFR 178.3570 of the food industry

**End fittings:** They are interchangeable and if necessary must be positively secured by the customer to prevent unscrewing.

**Safety instructions:** Gas pressure springs should not be installed under pre-tension.

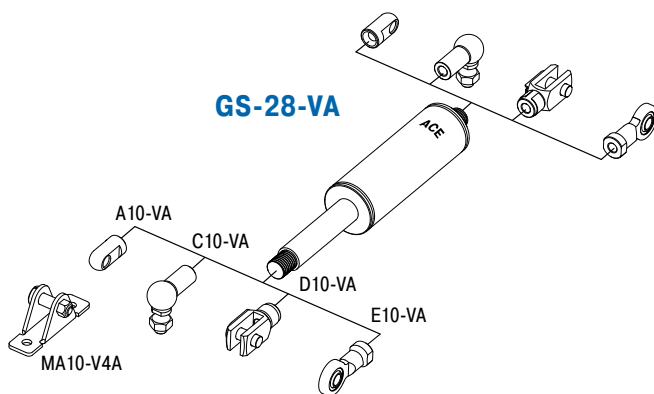



End Fitting

Standard Dimensions

End Fitting

**Performance and Dimensions**

| TYPES        | Stroke mm | L extended mm | Extension force max. N |
|--------------|-----------|---------------|------------------------|
| GS-40-100-VA | 100       | 317           | 5,000                  |
| GS-40-150-VA | 150       | 417           | 5,000                  |
| GS-40-200-VA | 200       | 517           | 5,000                  |
| GS-40-300-VA | 300       | 717           | 5,000                  |
| GS-40-400-VA | 400       | 917           | 5,000                  |
| GS-40-500-VA | 500       | 1,117         | 5,000                  |
| GS-40-600-VA | 600       | 1,317         | 4,150                  |

**Ordering Example**

**GS-40-150-DD-3500-VA**

Type (Push Type) \_\_\_\_\_  
 Body Ø (40 mm) \_\_\_\_\_  
 Stroke (150 mm) \_\_\_\_\_  
 Piston Rod End Fitting D14-VA \_\_\_\_\_  
 Body End Fitting D14-VA \_\_\_\_\_  
 Nominal Force F<sub>1</sub> 3500 N \_\_\_\_\_  
 Material (1.4301/1.4305, AISI 304/303, VA) \_\_\_\_\_

**Mounting accessories see from page 208.**

**Adjuster Knob DE-GAS-14**  
See page 175.

**End Fitting Options:**  
 Stud Thread **B14**  
 Eye **A14-VA** max. force 7,000 N  
 Angle Ball Joint **C14-VA** max. force 3,200 N  
 Clevis Fork **D14-VA** max. force 7,000 N  
 Swivel Eye **E14-VA** max. force 7,000 N

**Rod Shroud W14-40-VA**  
L = Stroke + 40

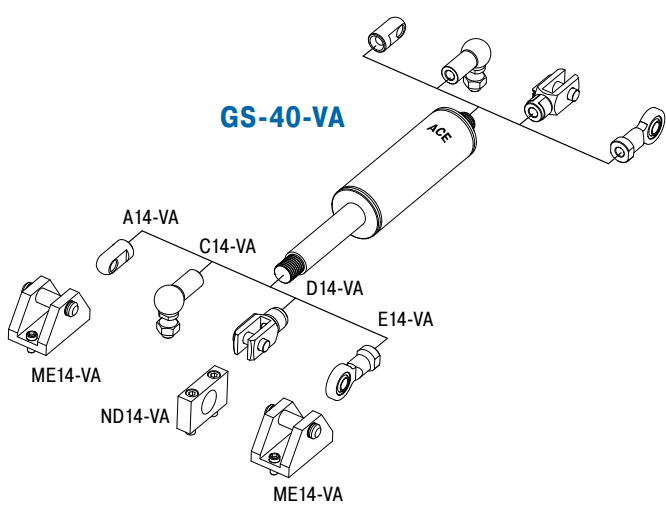

Technical Data

- Extension force:** 500 N to 5,000 N (compressed up to 7,100 N)
- Progression:** Approx. 34 % to 42 %
- Operating temperature range:** -20 °C to +80 °C
- Material:** Outer body, Piston rod, End fittings: stainless steel (1.4301/1.4305, AISI 304/303)
- Mounting:** We recommend mounting with piston rod downwards to take advantage of the built-in end position damping.
- End position damping length:** approx. 30 mm (depending on the stroke)
- Positive stop:** External positive stop at the end of stroke provided by the customer.
- Note:** Special oil according to FDA 21 CFR 178.3570 of the food industry
- End fittings:** They are interchangeable and if necessary must be positively secured by the customer to prevent unscrewing.
- Safety instructions:** Gas pressure springs should not be installed under pre-tension.

Issue 07.2017 – Specifications subject to change

## Stainless Steel Gas Springs (Push Type), V4A

| TYPES         | Stroke<br>mm | L extended<br>mm | Dimensions<br>see Page |
|---------------|--------------|------------------|------------------------|
| GS-15-20-V4A  | 20           | 74               | 148                    |
| GS-15-40-V4A  | 40           | 114              | 148                    |
| GS-15-50-V4A  | 50           | 134              | 148                    |
| GS-15-60-V4A  | 60           | 154              | 148                    |
| GS-15-80-V4A  | 80           | 194              | 148                    |
| GS-15-100-V4A | 100          | 234              | 148                    |
| GS-15-120-V4A | 120          | 274              | 148                    |
| GS-15-150-V4A | 150          | 334              | 148                    |
| GS-19-50-V4A  | 50           | 164              | 149                    |
| GS-19-100-V4A | 100          | 264              | 149                    |
| GS-19-150-V4A | 150          | 364              | 149                    |
| GS-19-200-V4A | 200          | 464              | 149                    |
| GS-19-250-V4A | 250          | 564              | 149                    |
| GS-19-300-V4A | 300          | 664              | 149                    |
| GS-22-50-V4A  | 50           | 164              | 150                    |
| GS-22-100-V4A | 100          | 264              | 150                    |
| GS-22-150-V4A | 150          | 364              | 150                    |
| GS-22-200-V4A | 200          | 464              | 150                    |
| GS-22-250-V4A | 250          | 564              | 150                    |
| GS-22-300-V4A | 300          | 664              | 150                    |
| GS-22-350-V4A | 350          | 764              | 150                    |
| GS-22-400-V4A | 400          | 864              | 150                    |
| GS-22-450-V4A | 450          | 964              | 150                    |
| GS-22-500-V4A | 500          | 1,064            | 150                    |
| GS-22-550-V4A | 550          | 1,164            | 150                    |
| GS-22-600-V4A | 600          | 1,264            | 150                    |
| GS-22-650-V4A | 650          | 1,364            | 150                    |
| GS-22-700-V4A | 700          | 1,464            | 150                    |
| GS-28-100-V4A | 100          | 262              | 151                    |
| GS-28-150-V4A | 150          | 362              | 151                    |
| GS-28-200-V4A | 200          | 462              | 151                    |
| GS-28-250-V4A | 250          | 562              | 151                    |
| GS-28-300-V4A | 300          | 662              | 151                    |
| GS-28-350-V4A | 350          | 762              | 151                    |
| GS-28-400-V4A | 400          | 862              | 151                    |
| GS-28-450-V4A | 450          | 962              | 151                    |
| GS-28-500-V4A | 500          | 1,062            | 151                    |
| GS-28-550-V4A | 550          | 1,162            | 151                    |
| GS-28-600-V4A | 600          | 1,262            | 151                    |
| GS-28-650-V4A | 650          | 1,362            | 151                    |
| GS-40-100-V4A | 100          | 317              | 152                    |
| GS-40-150-V4A | 150          | 417              | 152                    |
| GS-40-200-V4A | 200          | 517              | 152                    |
| GS-40-300-V4A | 300          | 717              | 152                    |
| GS-40-400-V4A | 400          | 917              | 152                    |
| GS-40-500-V4A | 500          | 1,117            | 152                    |
| GS-40-600-V4A | 600          | 1,317            | 152                    |

## Stainless Steel Accessories, V4A

| TYPES   | Dimensions<br>see Page |
|---------|------------------------|
| A5-V4A  | 210                    |
| C5-V4A  | 210                    |
| D5-V4A  | 210                    |
| E5-V4A  | 210                    |
| G5-V4A  | 210                    |
| A8-V4A  | 211                    |
| C8-V4A  | 211                    |
| D8-V4A  | 211                    |
| E8-V4A  | 211                    |
| G8-V4A  | 212                    |
| A10-V4A | 212                    |
| C10-V4A | 212                    |
| D10-V4A | 212                    |
| E10-V4A | 212                    |
| A14-V4A | 213                    |
| C14-V4A | 213                    |
| D14-V4A | 213                    |
| E14-V4A | 213                    |

## GST-40 Tandem

Optimised dual force for heavy flaps and wide angle applications

### Valve Technology

**Force range 300 N to 5,000 N**

**Stroke 50 mm to 400 mm**

Cover two differing force ranges: Tandem push type gas springs by ACE are maintenance-free and ready-to-install with two pressure tubes with different extension forces and progression curves. With this type of gas spring you cover the different force ranges between the start and end of an application. These force ranges are adjusted and complement each other, designed individually for the relevant application by the free of charge ACE calculation service, then are specifically manufactured adjusted precisely to the required dynamics of the application.

The customer specific systems, for which there are many fitting parts, are specifically suitable for heavy loads with large opening angle and can also be delivered in stainless steel versions.

Tandem push type gas springs from ACE are used in industrial applications such as in mechanical engineering, in the automobile, electronics and furniture industries, but also in medical technology as well as for service hatches.

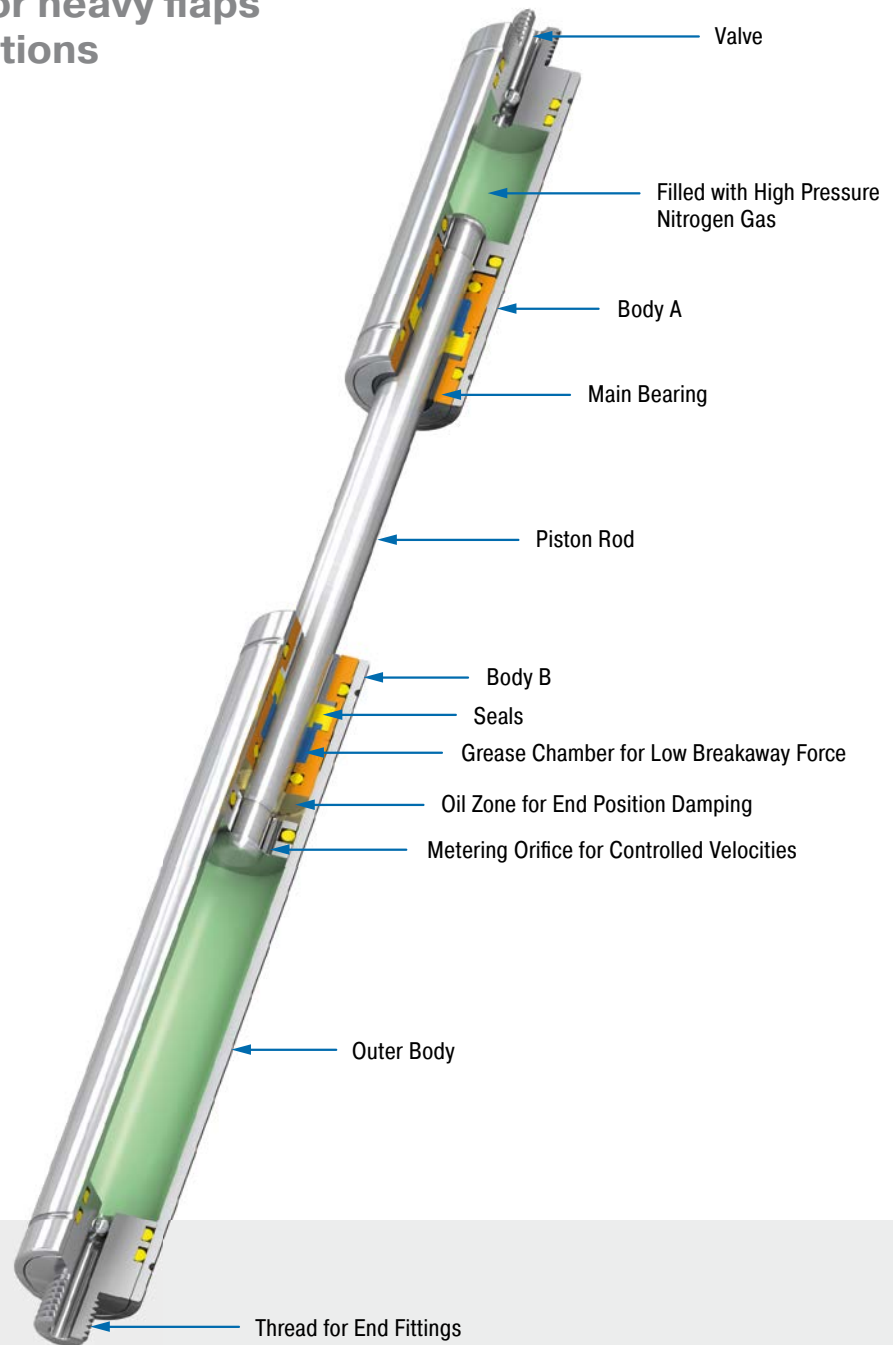

### Technical Data

**Extension force:** 300 N to 5,000 N

**Piston rod diameter:** Ø 20 mm

**Progression:** according to calculation relating to your application

**Lifetime:** Approx. 10,000 m

**Operating temperature range:** -20 °C to +80 °C

**Material:** Outer body, End fittings: zinc plated steel; Piston rod: steel with wear-resistant coating

**Operating fluid:** nitrogen gas and oil

**Mounting:** in any position. Please adopt the mounting points determined by ACE.

**End position damping length:** Application-specific end position damping and extension speed.

**Positive stop:** External positive stop at the end of stroke provided by the customer.

**Application field:** hoods, shutters, machine housing, conveyor systems, folding elements, loading and lifting equipment

**Note:** These gas springs are tailored to the relevant application and are therefore not available ex stock.

**End fittings:** They are interchangeable and if necessary must be positively secured by the customer to prevent unscrewing.

**On request:** Special oils and other special options. Alternative accessories. Material 1.4301/1.4305, AISI 304/303 (V2A) and 1.4404/1.4571, AISI 316L/316Ti (V4A).

### End Fitting

### Standard Dimensions

### End Fitting

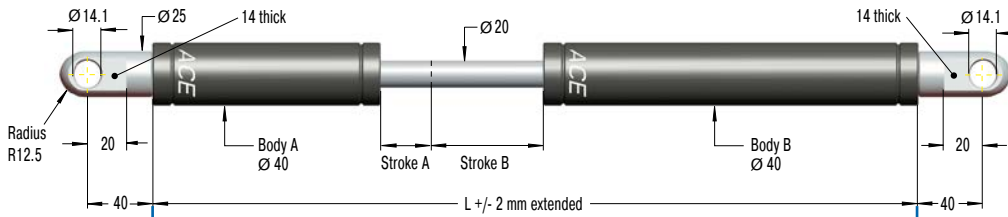
**A14**

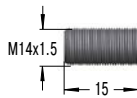
**Eye A14**  
max. force 10,000 N

**B14**

### Performance and Dimensions

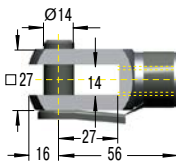
| TYPES         | Stroke A<br>mm | Stroke B<br>mm | L extended<br>mm | Extension force max.<br>N |
|---------------|----------------|----------------|------------------|---------------------------|
| GST-40-50-100 | 50             | 100            | 485              | 5,000                     |
| GST-40-50-150 | 50             | 150            | 585              | 5,000                     |
| GST-40-50-200 | 50             | 200            | 685              | 5,000                     |
| GST-40-70-250 | 70             | 250            | 825              | 5,000                     |
| GST-40-70-300 | 70             | 300            | 925              | 5,000                     |
| GST-40-70-350 | 70             | 350            | 1,025            | 5,000                     |
| GST-40-70-400 | 70             | 400            | 1,125            | 5,000                     |

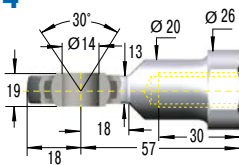
**Stud Thread B14**
**D14**

**Clevis Fork D14**  
max. force 10,000 N

**E14**

**Swivel Eye E14**  
max. force 10,000 N

### Ordering Example

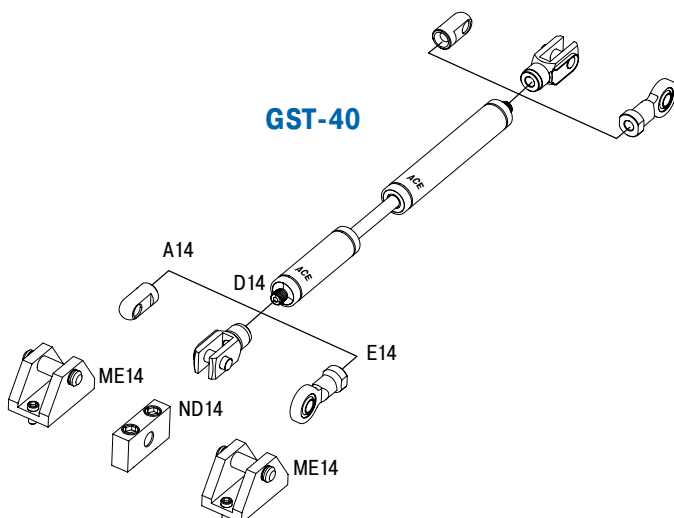
**GST-40-50-150-AD-900N-2500N**

Type (Tandem Gas Spring) \_\_\_\_\_  
 Body Ø (40 mm) \_\_\_\_\_  
 Stroke A (50 mm) \_\_\_\_\_  
 Stroke B (150 mm) \_\_\_\_\_  
 Body A End Fitting, A14 \_\_\_\_\_  
 Body B End Fitting, D14 \_\_\_\_\_  
 Nominal Force Body A, 900 N \_\_\_\_\_  
 Nominal Force Body B, 2500 N \_\_\_\_\_

**Mounting accessories see from page 200.**

### Technical Data

**Extension force:** 300 N to 5,000 N

**Progression:** according to calculation relating to your application

**Operating temperature range:** -20 °C to +80 °C

**Material:** Outer body, End fittings: zinc plated steel; Piston rod: steel with wear-resistant coating

**Mounting:** in any position. Please adopt the mounting points determined by ACE.

**End position damping length:** Application-specific end position damping and extension speed.

**Positive stop:** External positive stop at the end of stroke provided by the customer.

**Note:** These gas springs are tailored to the relevant application and are therefore not available ex stock.

**End fittings:** They are interchangeable and if necessary must be positively secured by the customer to prevent unscrewing.

## Application Examples

### GS-12

#### Safe opening and closing

ACE industrial gas springs (push type) protect samples in an incubator, which is used for chemical and biochemical applications. The plexiglass hood, under which may be found valuable laboratory goods, is securely held open by two maintenance-free, ready-to-install ACE industrial gas springs (push type) of the type GS-12-60-AA-X. With an end-position damping of 5 mm and an extension force of 10 to 180 N, they help to handle the forces generated. The hood is always easily opened and remains in this position. It also remains securely shut when the incubator is in operation.



Very small ACE industrial gas springs (push type) enable careful opening and closing movements of a mini-incubator hood, under which may be found laboratory products

GFL Gesellschaft für Labortechnik mbH, 30938 Burgwedel, Germany

### GS-19

#### Doors open and close safely

ACE industrial gas springs make opening and closing doors of rescue helicopters easier. The maintenance-free, sealed systems are installed in the access doors of helicopters of the type EC 135. There, they allow the crew to enter or exit the helicopter quickly, thus contributing to enhanced safety. The GS-19-300-CC gas springs provide a defined retraction speed and secure engagement of the door lock. The integrated end position damper allows gentle closing of the door and saves wear and tear on the valuable, lightweight material.

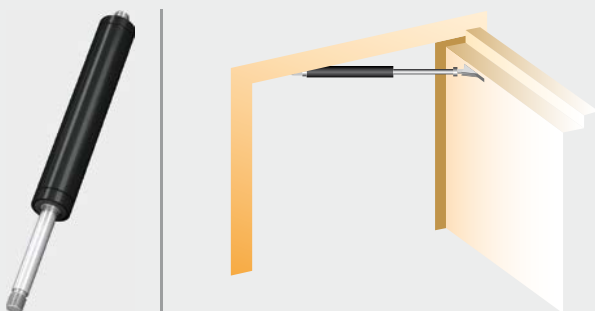

Industrial gas springs: For safe entry and exit



**GS-22-VA**
**Made-to-measure stainless steel gas springs**

A special hygiene and toilet chair, designed for children and young people with disabilities, must be firmly lockable in the sit and tilt positions. The practical aid thereby provided for relatives and carers can be attributed to two lockable ACE industrial gas springs (push type) which were especially developed and manufactured for this application and operate on the basis of the so-called tilt-in-space function. This allows the chair to be tilted forwards and backwards and provides significantly more convenience for users and patients. In order to meet all hygiene requirements, the gas springs are constructed in stainless steel.

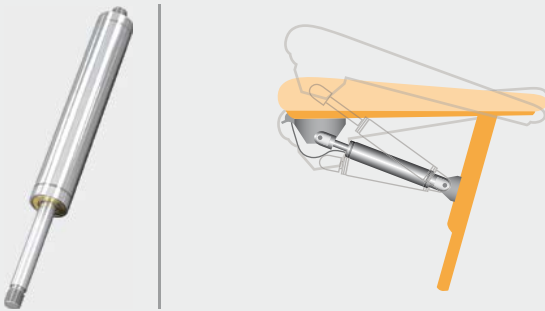

With inclination angles of 15 degrees to the front and rear, the ACE stainless steel gas springs facilitate the work of nurses  
Rifton Equipment, Rifton, New York 12471, USA

**GST-40**
**Tandemly-operated large flaps securely under control**

Underground distribution systems are visually advantageous. To facilitate their servicing, the heavy covers of the often large supply systems are brought back to the surface with the help of ACE industrial tandem gas springs (push type). This is quite easily achieved thanks to the use of two pressure pipes, the result of which is two different force ranges. This means fitters must not endure laborious bending and a downward passage into the system of channels. In addition to these advantages, the springs benefit from their long service life and their capacity to be used, as stainless steel variants, in even the most hygienically-sensitive areas.



ACE industrial tandem gas springs (push type) enable easy maintenance of supply boxes by making the heavy flaps easier to operate  
Langmatz GmbH, 82467 Garmisch-Partenkirchen, Germany



# Industrial Gas Springs – Pull Type

## Takes over when things get too tight for gas pressure springs

If ACE gas push type springs cannot be used due to a lack of space, ACE's industrial gas pull type springs come into their own. The compact assistants with body diameters of 15 mm to 40 mm are effective in the direction of traction and work in the opposite way to the principle of gas push type springs.

This means that the gas pressure in the cylinder draws the piston rod in and, when closing a flap for example, supports the manual force with the pressure springs. ACE's gas pull type springs are also self-contained, maintenance-free machine elements and equipped with a standard valve to individually regulate the gas pressure, whereby they cover forces between 30 N and 5,000 N. Any installation position, extensive DIN standardised accessories and various models enable universal use.

Compact design

Individual filling valve technology

Calculation program for specific design

Universally applicable

Delivery time within 24 hours



## Function of a Gas Spring – Pull Type

Gas pull type springs work based on the reverse principle of a gas push type spring. They are also individually filled according to customer request to a certain pressure (traction force  $F_1$ ). However, the piston rod here is pulled inwards by the gas pressure in the cylinder. The higher the pressure, the greater the traction force.

The piston ring surface between the piston rod and the inner tube is decisive for the function. When the piston rod pulls out, the nitrogen from the piston is compressed in the inner tube. The force increase (progression) of the gas spring is due to the rising pressure. The force increase is almost linear.

Free calculation service see page 172!

### Calculation Principles

#### Force-Stroke Characteristics of Traction Gas Spring (Pull Type)

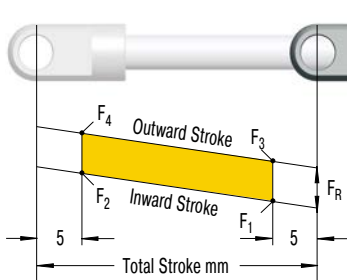

$F_1$  = nominal force at 20 °C (this is the pressure figure normally used when specifying the gas spring)  
 $F_2$  = force in the complete extended position  
 When extending the piston rod, there is an additional friction force caused by the contact pressure of the seals (this only occurs during the extension stroke):  
 $F_3$  = force at the beginning of the extension stroke  
 $F_4$  = force at the end of the extension stroke

#### Gas Springs (Pull Type)

| TYPES | Progression approx. % | <sup>1</sup> Friction $F_R$ approx. in N |
|-------|-----------------------|--|
| GZ-15 | 12 - 22 <sup>2</sup>  | 55 - 140                                 |
| GZ-19 | 21 - 28 <sup>2</sup>  | 20 - 40                                  |
| GZ-28 | 28 - 30 <sup>2</sup>  | 100 - 200                                |
| GZ-40 | 43 - 45 <sup>2</sup>  |  |

<sup>1</sup> Depending on the filling force  
<sup>2</sup> Depending on the stroke

**Progression:** (the slope of the force line in the diagram above) is due to the reduction of the internal gas volume as the piston rod moves from its initial position to its fully stroked position. The approx. progression values given above for standard springs can be altered on request.

**Effect of temperature:** The nominal  $F_1$  figure is given at 20 °C. An increase of 10 °C will increase force by 3.4 %.

**Filling tolerances:** -20 N to +40 N or 5 % to 7 %. Depending on size and traction force the tolerances can differ.

## Industrial Gas Springs – Pull Type



### GZ-15 to GZ-40

Valve Technology  
**Very low progression rate**  
 Hoods, Shutters, Machine housing, Conveyor systems

Page 160

### GZ-15-V4A to GZ-40-VA

Valve Technology, Stainless Steel  
**Very low progression rate with FDA approval**  
 Hoods, Shutters, Machine housing, Conveyor systems

Page 166

## GZ-15 to GZ-40

Very low progression rate

### Valve Technology

Traction force range 40 N to 5,000 N

Stroke 20 mm to 650 mm

The solution to a lack of space: If standard push type gas springs cannot be used due to a lack of space, ACE's industrial pull type gas springs come into their own. They work in the opposite way to standard push type gas springs. The piston rod is retracted when the cylinder is unloaded. The gas pressure in the cylinder draws the piston rod in.

ACE pull type gas springs offer the maximum service life thanks to the solid chrome-plated piston rod and an integrated sliding bearing. The maintenance-free and ready-to-install products are available in body diameters of 15 to 40 mm as well as forces from 40 to 5,000 N and are available from stock with valve and large selection of accessories. The traction force can be subsequently adjusted using the valve.

Gas traction springs from ACE are used in industrial applications, especially in mechanical engineering and in medical technology as well as in the electronics and furniture industries.

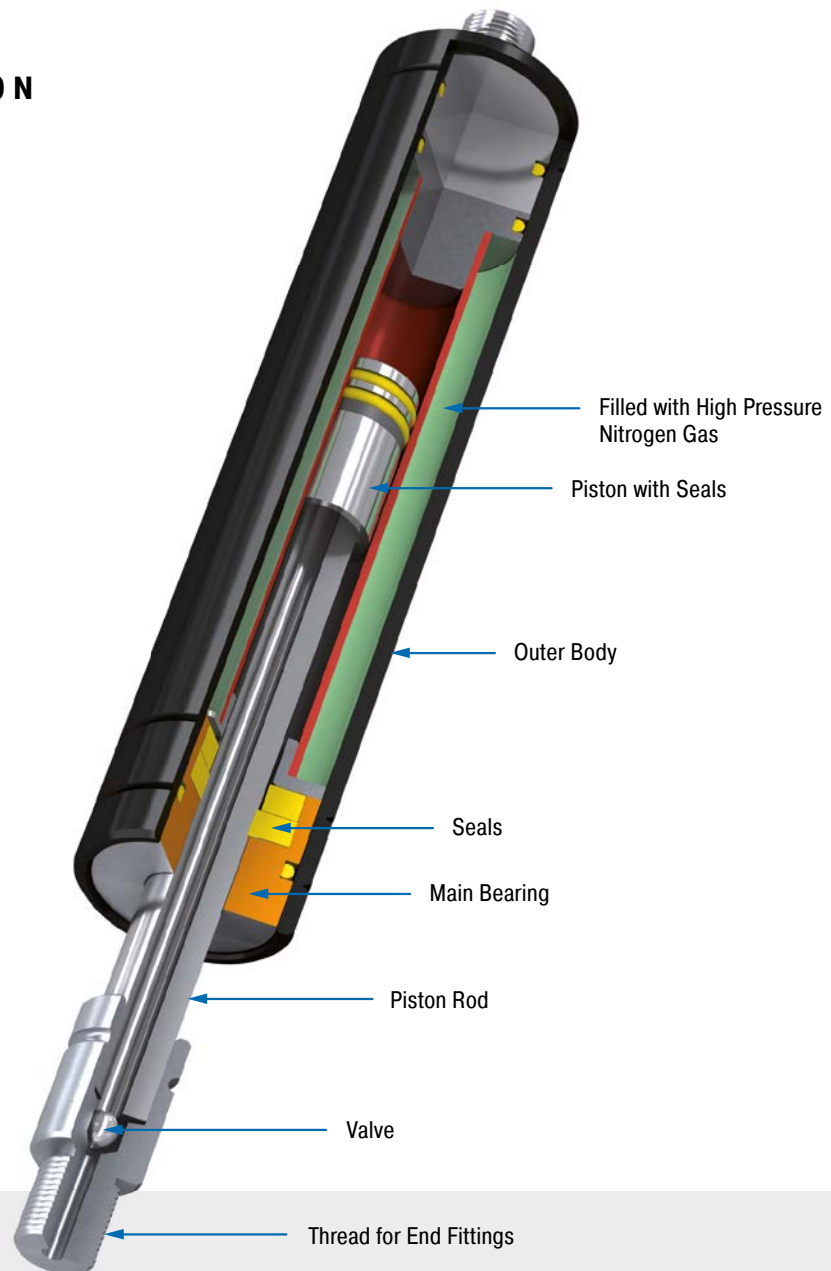

### Technical Data

**Traction force:** 40 N to 5,000 N

**Piston rod diameter:** Ø 4 mm to Ø 28 mm

**Progression:** approx. 12 % to 45 %

**Lifetime:** Approx. 2,000 m

**Operating temperature range:** -20 °C to +80 °C

**Material:** Outer body, End fittings: zinc plated steel; Piston rod: steel or stainless steel with wear-resistant coating

**Operating fluid:** nitrogen gas

**Mounting:** with piston rod upwards

**End position damping length:** Without damping. For end position damping use damping material (e.g. TUBUS or SLAB).

**Positive stop:** External positive stop at the end of stroke provided by the customer.

**Application field:** hoods, shutters, machine housing, conveyor systems, control boxes, furniture industry, shipbuilding, assembly stations, vehicle technology, folding elements

**End fittings:** They are interchangeable and if necessary must be positively secured by the customer to prevent unscrewing.

**On request:** Special oils and other special options. Alternative accessories. Traction gas springs with end position damping also available on request.

Valve Technology, Traction force 50 N to 150 N (extended up to 183 N)

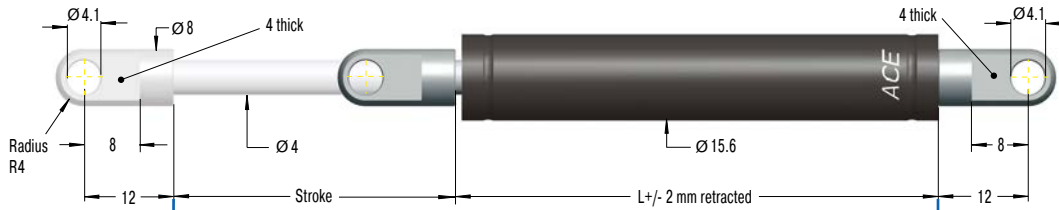
**End Fitting**
**Standard Dimensions**
**End Fitting**
**A3,5**

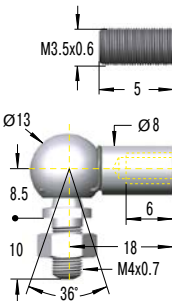
**Eye A3,5**  
max. force 370 N

**B3,5**
**C3,5**

**Performance and Dimensions**

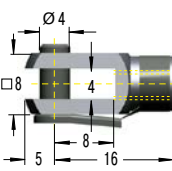
| TYPES     | Stroke mm | L retracted mm | Traction force max. N |
|-----------|-----------|----------------|-----------------------|
| GZ-15-20  | 20        | 87             | 150                   |
| GZ-15-40  | 40        | 107            | 150                   |
| GZ-15-50  | 50        | 117            | 150                   |
| GZ-15-60  | 60        | 127            | 150                   |
| GZ-15-80  | 80        | 147            | 150                   |
| GZ-15-100 | 100       | 167            | 150                   |
| GZ-15-120 | 120       | 187            | 150                   |
| GZ-15-150 | 150       | 217            | 150                   |

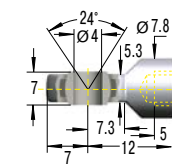
**Stud Thread B3,5**
**Angle Ball Joint C3,5**  
max. force 370 N

**D3,5**

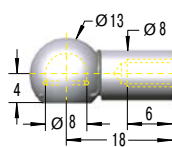
**Clevis Fork D3,5**  
max. force 370 N

**E3,5**

**Swivel Eye E3,5**  
max. force 370 N

**G3,5**

**Ball Socket G3,5**  
max. force 370 N

**Ordering Example**
**GZ-15-150-AC-150**

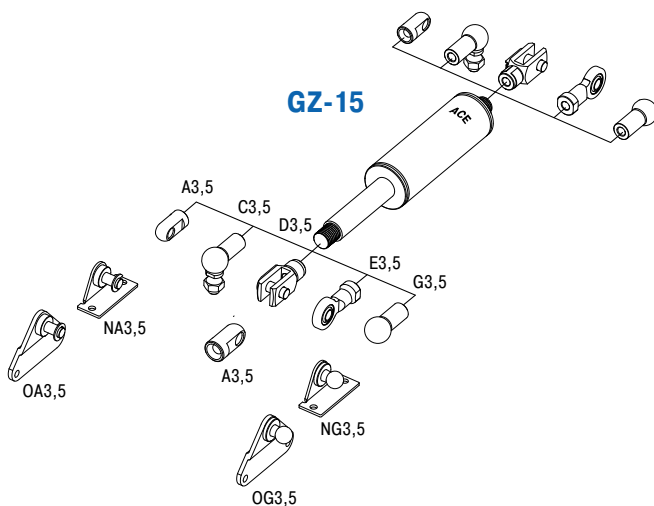
Type (Pull Type) \_\_\_\_\_  
 Body Ø (15.6 mm) \_\_\_\_\_  
 Stroke (150 mm) \_\_\_\_\_  
 Piston Rod End Fitting A3,5 \_\_\_\_\_  
 Body End Fitting C3,5 \_\_\_\_\_  
 Traction Force  $F_1$  150 N \_\_\_\_\_

Mounting accessories see from page 200.

**Technical Data**
**Traction force:** 50 N to 150 N (extended up to 183 N)

**Progression:** Approx. 12 % to 22 %

**Lifetime:** Approx. 2,000 m

**Operating temperature range:** -20 °C to +80 °C

**Material:** Outer body, End fittings: zinc plated steel; Piston rod: stainless steel (1.4301/1.4305, AISI 304/303)

**Mounting:** with piston rod upwards

**End position damping length:** Without damping. For end position damping use damping material (e.g. TUBUS or SLAB).

**Positive stop:** External positive stop at the end of stroke provided by the customer.

**End fittings:** They are interchangeable and if necessary must be positively secured by the customer to prevent unscrewing.

Valve Technology, Traction force 40 N to 350 N (extended up to 448 N)

**End Fitting**

**Standard Dimensions**

**End Fitting**

**Performance and Dimensions**

| TYPES     | Stroke mm | L retracted mm | Traction force max. N |
|-----------|-----------|----------------|-----------------------|
| GZ-19-30  | 30        | 112            | 350                   |
| GZ-19-50  | 50        | 132            | 350                   |
| GZ-19-100 | 100       | 182            | 350                   |
| GZ-19-150 | 150       | 232            | 350                   |
| GZ-19-200 | 200       | 282            | 350                   |
| GZ-19-250 | 250       | 332            | 350                   |

**Ordering Example**

**GZ-19-150-AC-250**

- Type (Pull Type)
- Body Ø (19 mm)
- Stroke (150 mm)
- Piston Rod End Fitting A8
- Body End Fitting C8
- Traction Force  $F_1$  250 N

**End Fitting Options:**

- Eye A8** max. force 3,000 N
- Stud Thread B8**
- Angle Ball Joint C8** max. force 1,200 N
- Clevis Fork D8** max. force 3,000 N
- Swivel Eye E8** max. force 3,000 N
- Ball Socket G8** max. force 1,200 N

**Rod Shroud W8-19**

Ø 23  
L = Stroke + 30

**Adjuster Knob DE-GAS-8**  
See page 175.

Mounting accessories see from page 200.

**Adjuster Knob DE-GAS-8**

See page 175.

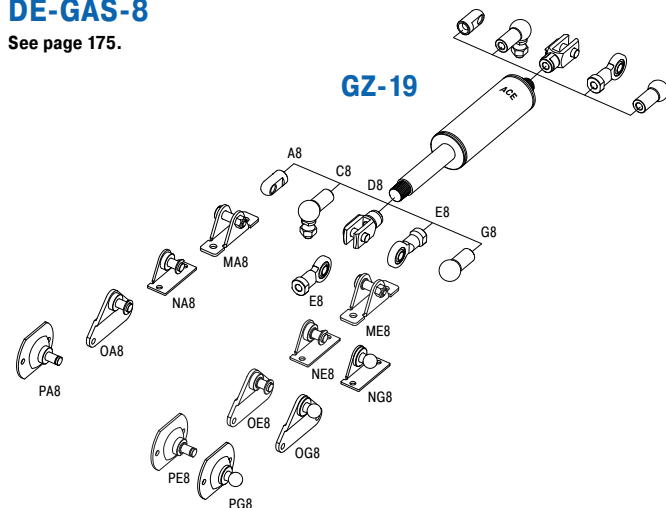

**Technical Data**

- Traction force:** 40 N to 350 N (extended up to 448 N)
- Progression:** Approx. 21 % to 28 %
- Lifetime:** Approx. 2,000 m
- Operating temperature range:** -20 °C to +80 °C
- Material:** Outer body, End fittings: zinc plated steel; Piston rod: steel with wear-resistant coating
- Mounting:** with piston rod upwards
- End position damping length:** Without damping. For end position damping use damping material (e.g. TUBUS or SLAB).
- Positive stop:** External positive stop at the end of stroke provided by the customer.
- End fittings:** They are interchangeable and if necessary must be positively secured by the customer to prevent unscrewing.

Valve Technology, Traction force 150 N to 1,200 N (extended up to 1,560 N)

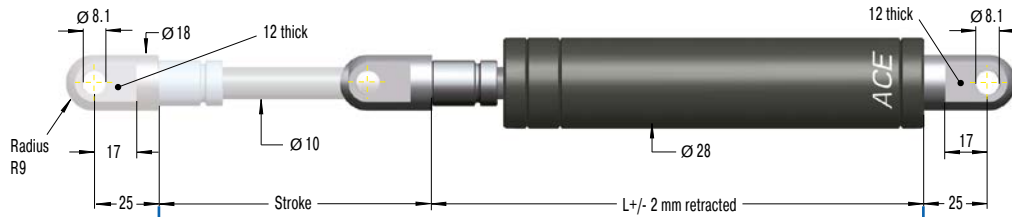
**End Fitting**
**Standard Dimensions**
**End Fitting**
**A10**

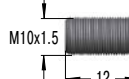
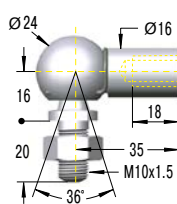
**Eye A10**  
max. force 10,000 N

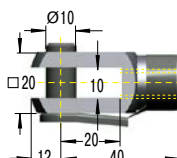
**B10**

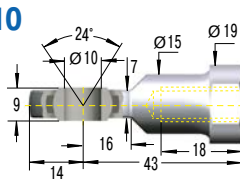
**Stud Thread B10**
**C10**

**Angle Ball Joint C10**  
max. force 1,800 N

**D10**

**Clevis Fork D10**  
max. force 10,000 N

**E10**

**Swivel Eye E10**  
max. force 10,000 N

**Performance and Dimensions**

| TYPES     | Stroke<br>mm | L retracted<br>mm | Traction force max.<br>N |
|-----------|--------------|-------------------|--------------------------|
| GZ-28-30  | 30           | 130               | 1,200                    |
| GZ-28-50  | 50           | 150               | 1,200                    |
| GZ-28-100 | 100          | 200               | 1,200                    |
| GZ-28-150 | 150          | 250               | 1,200                    |
| GZ-28-200 | 200          | 300               | 1,200                    |
| GZ-28-250 | 250          | 350               | 1,200                    |
| GZ-28-300 | 300          | 400               | 1,200                    |
| GZ-28-350 | 350          | 450               | 1,200                    |
| GZ-28-400 | 400          | 500               | 1,200                    |
| GZ-28-450 | 450          | 550               | 1,200                    |
| GZ-28-500 | 500          | 600               | 1,200                    |
| GZ-28-550 | 550          | 650               | 1,200                    |
| GZ-28-600 | 600          | 700               | 1,200                    |
| GZ-28-650 | 650          | 750               | 1,200                    |

**Ordering Example**
**GZ-28-150-EE-800**

Type (Pull Type) \_\_\_\_\_  
 Body Ø (28 mm) \_\_\_\_\_  
 Stroke (150 mm) \_\_\_\_\_  
 Piston Rod End Fitting E10 \_\_\_\_\_  
 Body End Fitting E10 \_\_\_\_\_  
 Traction Force F<sub>1</sub> 800 N \_\_\_\_\_

Mounting accessories see from page 200.

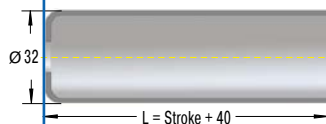
**Rod Shroud W10-28**

**Adjuster Knob DE-GAS-10**

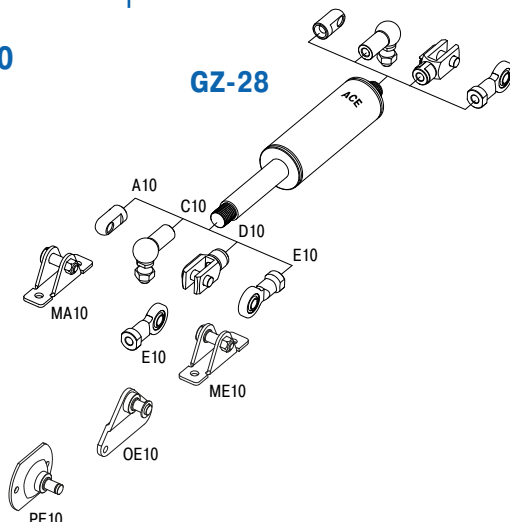
See page 175.

**GZ-28**

**Technical Data**
**Traction force:** 150 N to 1,200 N (extended up to 1,560 N)

**Progression:** Approx. 28 % to 30 %

**Lifetime:** Approx. 2,000 m

**Operating temperature range:** -20 °C to +80 °C

**Material:** Outer body, End fittings: zinc plated steel; Piston rod: steel with wear-resistant coating

**Mounting:** with piston rod upwards

**End position damping length:** Without damping. For end position damping use damping material (e.g. TUBUS or SLAB).

**Positive stop:** External positive stop at the end of stroke provided by the customer.

**End fittings:** They are interchangeable and if necessary must be positively secured by the customer to prevent unscrewing.



Valve Technology, Traction force 500 N to 5,000 N (extended up to 7,250 N)

**End Fitting**

**Standard Dimensions**

**End Fitting**

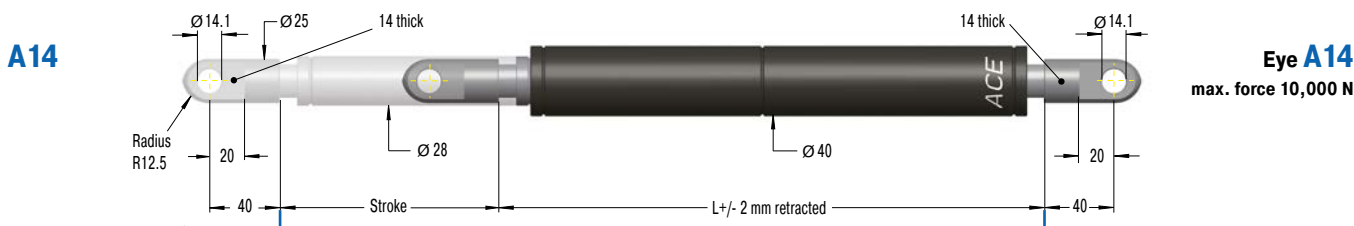

**B14**

**Stud Thread B14**

**C14**

**Angle Ball Joint C14**

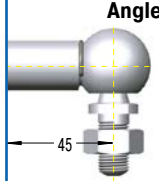
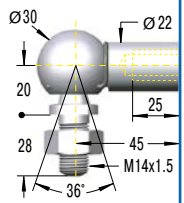

**D14**

**Clevis Fork D14**

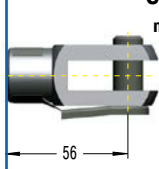
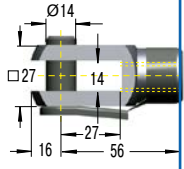

**E14**

**Swivel Eye E14**

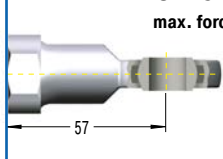
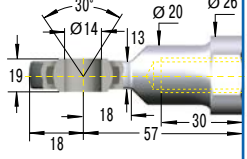

**Performance and Dimensions**

| TYPES     | Stroke mm | L retracted mm | Traction force max. N |
|-----------|-----------|----------------|-----------------------|
| GZ-40-100 | 100       | 250            | 5,000                 |
| GZ-40-150 | 150       | 325            | 5,000                 |
| GZ-40-200 | 200       | 400            | 5,000                 |
| GZ-40-250 | 250       | 475            | 5,000                 |
| GZ-40-300 | 300       | 550            | 5,000                 |
| GZ-40-400 | 400       | 700            | 5,000                 |
| GZ-40-500 | 500       | 850            | 5,000                 |
| GZ-40-600 | 600       | 1,000          | 5,000                 |

**Ordering Example**

**GZ-40-150-EE-800**

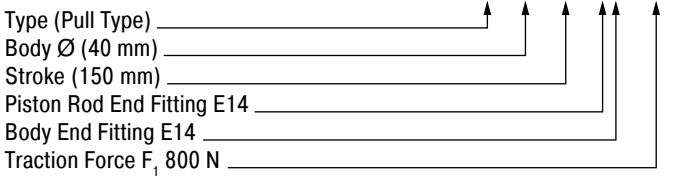

Mounting accessories see from page 200.

**Rod Shroud W14-40**

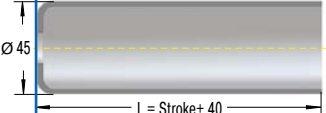

**Adjuster Knob DE-GAS-14**  
See page 175.

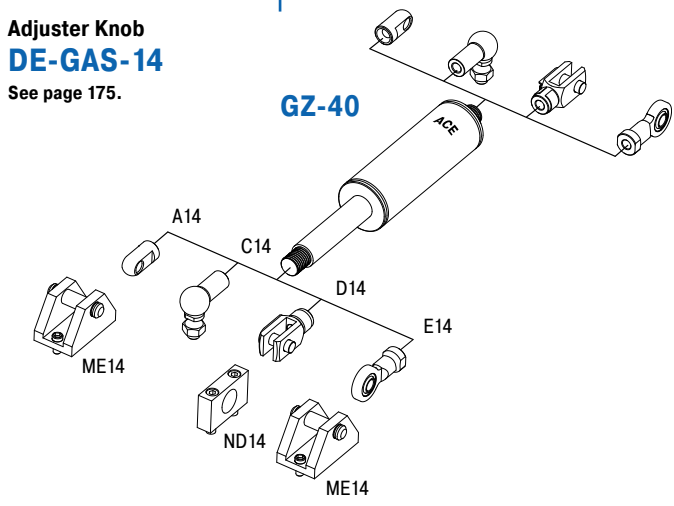

**Technical Data**

- Traction force:** 500 N to 5,000 N (extended up to 7,250 N)
- Progression:** Approx. 43 % to 45 %
- Lifetime:** Approx. 2,000 m
- Operating temperature range:** -20 °C to +80 °C
- Material:** Outer body, End fittings: zinc plated steel; Piston rod: steel with wear-resistant coating
- Mounting:** with piston rod upwards
- End position damping length:** Without damping. For end position damping use damping material (e.g. TUBUS or SLAB).
- Positive stop:** External positive stop at the end of stroke provided by the customer.
- End fittings:** They are interchangeable and if necessary must be positively secured by the customer to prevent unscrewing.

Issue 07.2017 – Specifications subject to change

# ACE Digital Tools



For more information  
about the calculation  
service see page 172!

**Print catalogue? Everyone can.  
ACE offers more:**

- ▶ Downloads: Product information in many languages
- ▶ PC calculation software & online calculation service
- ▶ Extensive CAD component libraries
- ▶ ACE-YouTube-Channel with video tips
- ▶ VibroChecker – awarded free iPhone App

**All information on our Website: [www.ace-ace.com](http://www.ace-ace.com)**

## GZ-15-V4A to GZ-40-VA

Very low progression rate with FDA approval

**Valve Technology, Stainless Steel**

**Traction force range 40 N to 5,000 N**

**Stroke 20 mm to 600 mm**

Brilliant performance when things become tight: For specific use e.g. in tough surroundings or small spaces, the broad spectrum of ACE industrial pull type gas springs made of stainless steel with body diameters from 15 mm to 40 mm supplements the comprehensive programme of the ACE industrial pull type gas springs with valves.

This high quality design is rust free and is more robust against environmental impact compared with standard gas pull type springs. These stainless steel gas springs are also optically appealing, very durable and available, upon request, in many stroke lengths and are also possible in many traction forces in combination with the suitable stainless steel accessories.

ACE industrial push type springs made of stainless steel are used in industries such as the chemical and food industry, in automobiles, plant engineering and shipbuilding and also in medical, military, environmental and water supply technology.

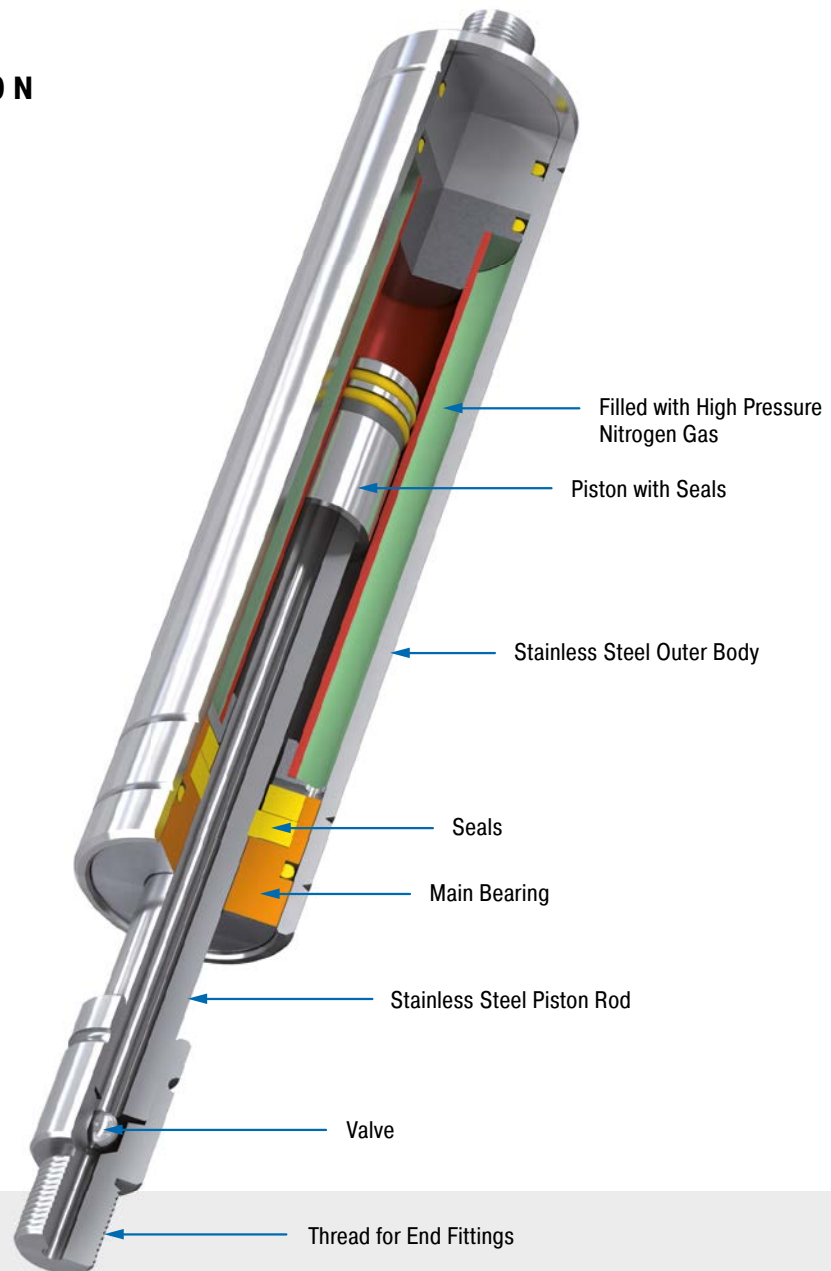

### Technical Data

**Traction force:** 40 N to 5,000 N

**Piston rod diameter:** Ø 4 mm to Ø 28 mm

**Progression:** approx. 11 % to 45 %

**Lifetime:** Approx. 2,000 m

**Operating temperature range:** -20 °C to +80 °C

**Material:** Outer body, Piston rod, End fittings: stainless steel (1.4301/1.4305, AISI 304/303 and 1.4404/1.4571, AISI 316L/316Ti)

**Operating fluid:** nitrogen gas

**Mounting:** with piston rod upwards

**End position damping length:** Without damping. For end position damping use damping material (e.g. TUBUS or SLAB).

**Positive stop:** External positive stop in the pulling direction provided by the customer.

**Application field:** hoods, shutters, machine housing, conveyor systems, control boxes, furniture industry, shipbuilding, food industry, pharmaceutical industry, folding elements

**End fittings:** They are interchangeable and if necessary must be positively secured by the customer to prevent unscrewing.

**On request:** Special oils and other special options. Alternative accessories. Traction gas springs with end position damping also available on request. Other traction gas springs material 1.4404/1.4571, AISI 316L/316Ti (V4A) available on request.

Valve Technology, Stainless Steel, Traction force 50 N to 150 N (extended up to 182 N)

**End Fitting**
**Standard Dimensions**
**End Fitting**

**B3,5**  
Stud Thread **B3,5**

**A3,5-V4A**  
Eye **A3,5-V4A**  
max. force 370 N

**C3,5-V4A**  
Angle Ball Joint **C3,5-V4A**  
max. force 370 N

**D3,5-V4A**  
Clevis Fork **D3,5-V4A**  
max. force 370 N

**G3,5-V4A**  
Ball Socket **G3,5-V4A**  
max. force 370 N

**Adjuster Knob DE-GAS-3,5**  
See page 175.

| Performance and Dimensions |              |                   |                          |
|----------------------------|--------------|-------------------|--------------------------|
| TYPES                      | Stroke<br>mm | L retracted<br>mm | Traction force max.<br>N |
| GZ-15-20-V4A               | 20           | 87                | 150                      |
| GZ-15-40-V4A               | 40           | 107               | 150                      |
| GZ-15-50-V4A               | 50           | 117               | 150                      |
| GZ-15-60-V4A               | 60           | 127               | 150                      |
| GZ-15-80-V4A               | 80           | 147               | 150                      |
| GZ-15-100-V4A              | 100          | 167               | 150                      |
| GZ-15-120-V4A              | 120          | 187               | 150                      |
| GZ-15-150-V4A              | 150          | 217               | 150                      |

**Ordering Example**  
**GZ-15-150-AC-150-V4A**

Type (Pull Type) \_\_\_\_\_  
 Body Ø (15.6 mm) \_\_\_\_\_  
 Stroke (150 mm) \_\_\_\_\_  
 Piston Rod End Fitting A3,5-V4A \_\_\_\_\_  
 Body End Fitting C3,5-V4A \_\_\_\_\_  
 Traction Force F<sub>1</sub> 150 N \_\_\_\_\_  
 Material (1.4404/1.4571, AISI 316L/316Ti, V4A) \_\_\_\_\_

**Mounting accessories see from page 208.**

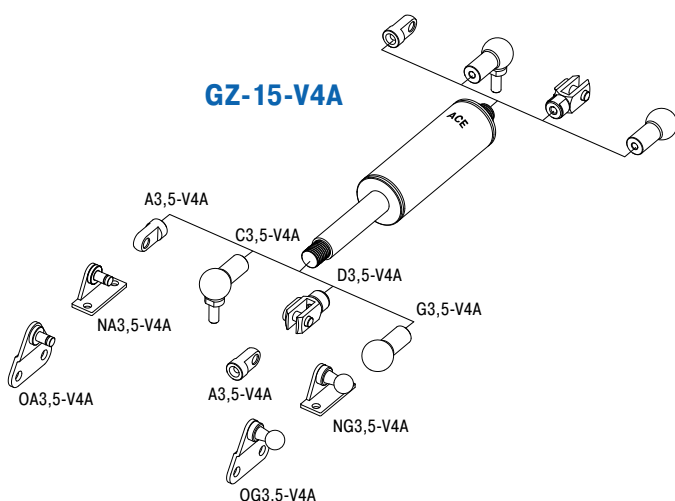
**Technical Data**
**Traction force:** 50 N to 150 N (extended up to 182 N)

**Progression:** Approx. 11 % to 21 %

**Lifetime:** Approx. 2,000 m

**Operating temperature range:** -20 °C to +80 °C

**Material:** Outer body, Piston rod, End fittings: stainless steel (1.4404/1.4571, AISI 316L/316Ti)

**Mounting:** with piston rod upwards

**End position damping length:** Without damping. For end position damping use damping material (e.g. TUBUS or SLAB).

**Positive stop:** External positive stop in the pulling direction provided by the customer.

**End fittings:** They are interchangeable and if necessary must be positively secured by the customer to prevent unscrewing.

End Fitting

Standard Dimensions

End Fitting

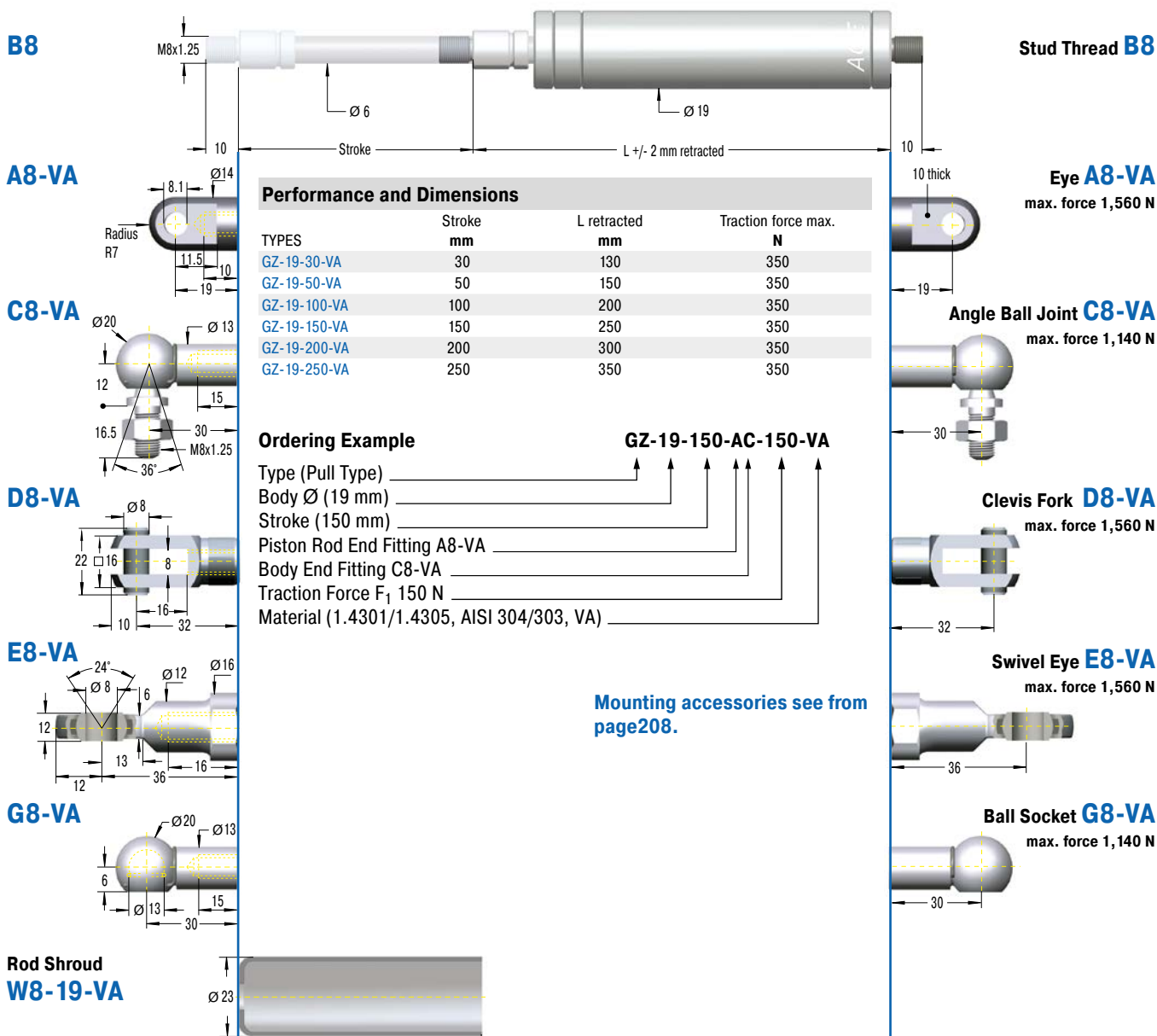

**Performance and Dimensions**

| TYPES        | Stroke mm | L retracted mm | Traction force max. N |
|--------------|-----------|----------------|-----------------------|
| GZ-19-30-VA  | 30        | 130            | 350                   |
| GZ-19-50-VA  | 50        | 150            | 350                   |
| GZ-19-100-VA | 100       | 200            | 350                   |
| GZ-19-150-VA | 150       | 250            | 350                   |
| GZ-19-200-VA | 200       | 300            | 350                   |
| GZ-19-250-VA | 250       | 350            | 350                   |

**Ordering Example**

**GZ-19-150-AC-150-VA**

Type (Pull Type) \_\_\_\_\_  
 Body Ø (19 mm) \_\_\_\_\_  
 Stroke (150 mm) \_\_\_\_\_  
 Piston Rod End Fitting A8-VA \_\_\_\_\_  
 Body End Fitting C8-VA \_\_\_\_\_  
 Traction Force F<sub>1</sub> 150 N \_\_\_\_\_  
 Material (1.4301/1.4305, AISI 304/303, VA) \_\_\_\_\_

Mounting accessories see from page 208.

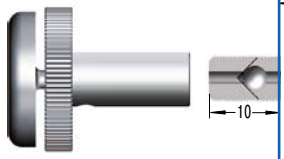

**Adjuster Knob DE-GAS-8**  
See page 175.

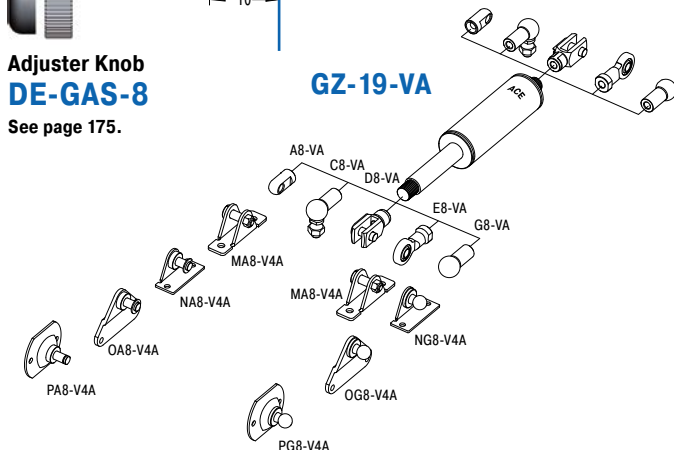

**Technical Data**

- Traction force:** 40 N to 350 N (extended up to 448 N)
- Progression:** Approx. 23 % to 28 %
- Lifetime:** Approx. 2,000 m
- Operating temperature range:** -20 °C to +80 °C
- Material:** Outer body, Piston rod, End fittings: stainless steel (1.4301/1.4305, AISI 304/303)
- Mounting:** with piston rod upwards
- End position damping length:** Without damping. For end position damping use damping material (e.g. TUBUS or SLAB).
- Positive stop:** External positive stop in the pulling direction provided by the customer.
- End fittings:** They are interchangeable and if necessary must be positively secured by the customer to prevent unscrewing.

Issue 07.2017 – Specifications subject to change



Valve Technology, Stainless Steel, Traction force 150 N to 1,200 N (extended up to 1,560 N)

**End Fitting**
**Standard Dimensions**
**End Fitting**

**B10**

M10x1.5

Ø 10

Stroke

12

ACE

Ø 28

L +/- 2 mm retracted

Stud Thread **B10**

**A10-VA**

Ø 18

Radius R9

8.1

15

15

27

| Performance and Dimensions |           |                |                       |
|----------------------------|-----------|----------------|-----------------------|
| TYPES                      | Stroke mm | L retracted mm | Traction force max. N |
| GZ-28-50-VA                | 50        | 165            | 1,200                 |
| GZ-28-100-VA               | 100       | 215            | 1,200                 |
| GZ-28-150-VA               | 150       | 265            | 1,200                 |
| GZ-28-200-VA               | 200       | 315            | 1,200                 |
| GZ-28-250-VA               | 250       | 365            | 1,200                 |
| GZ-28-300-VA               | 300       | 415            | 1,200                 |
| GZ-28-350-VA               | 350       | 465            | 1,200                 |
| GZ-28-400-VA               | 400       | 515            | 1,200                 |
| GZ-28-450-VA               | 450       | 565            | 1,200                 |
| GZ-28-500-VA               | 500       | 615            | 1,200                 |
| GZ-28-550-VA               | 550       | 665            | 1,200                 |
| GZ-28-600-VA               | 600       | 715            | 1,200                 |

Eye **A10-VA**

max. force 3,800 N

10 thick

27

**C10-VA**

Ø 24

Ø 16

16

18

20

35

M10x1.5

36°

Angle Ball Joint **C10-VA**

max. force 1,750 N

35

**D10-VA**

Ø 10

26.5

20

10

12

20

40

Clevis Fork **D10-VA**

max. force 3,800 N

40

**E10-VA**

24°

Ø 10

7

Ø 15

Ø 19

14

16

43

18

Swivel Eye **E10-VA**

max. force 3,800 N

43

**Ordering Example**

**GZ-28-150-EE-800-VA**

Type (Pull Type) \_\_\_\_\_

Body Ø (28 mm) \_\_\_\_\_

Stroke (150 mm) \_\_\_\_\_

Piston Rod End Fitting E10-VA \_\_\_\_\_

Body End Fitting E10-VA \_\_\_\_\_

Traction Force F<sub>1</sub> 800 N \_\_\_\_\_

Material (1.4301/1.4305, AISI 304/303, VA) \_\_\_\_\_

**Mounting accessories see from page 208.**

**Rod Shroud W10-28-VA**

Ø 32

L = Stroke + 40

**Adjuster Knob DE-GAS-10**

See page 175.

**GZ-28-VA**
**Technical Data**
**Traction force:** 150 N to 1,200 N (extended up to 1,560 N)

**Progression:** Approx. 29 % to 30 %

**Lifetime:** Approx. 2,000 m

**Operating temperature range:** -20 °C to +80 °C

**Material:** Outer body, Piston rod, End fittings: stainless steel (1.4301/1.4305, AISI 304/303)

**Mounting:** with piston rod upwards

**End position damping length:** Without damping. For end position damping use damping material (e.g. TUBUS or SLAB).

**Positive stop:** External positive stop in the pulling direction provided by the customer.

**End fittings:** They are interchangeable and if necessary must be positively secured by the customer to prevent unscrewing.



Valve Technology, Stainless Steel, Traction force 500 N to 5,000 N (extended up to 7,250 N)

**End Fitting**

**Standard Dimensions**

**End Fitting**



**A14-VA**

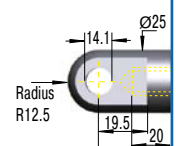

**Eye A14-VA**

max. force 7,000 N

**C14-VA**

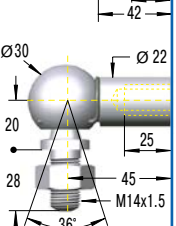

**Angle Ball Joint C14-VA**

max. force 3,200 N

**D14-VA**

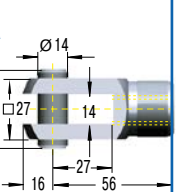

**Clevis Fork D14-VA**

max. force 7,000 N

**E14-VA**

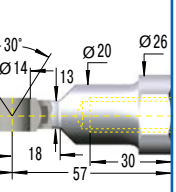

**Swivel Eye E14-VA**

max. force 7,000 N

**Performance and Dimensions**

| TYPES        | Stroke<br>mm | L retracted<br>mm | Traction force max.<br>N |
|--------------|--------------|-------------------|--------------------------|
| GZ-40-100-VA | 100          | 250               | 5,000                    |
| GZ-40-150-VA | 150          | 325               | 5,000                    |
| GZ-40-200-VA | 200          | 400               | 5,000                    |
| GZ-40-250-VA | 250          | 475               | 5,000                    |
| GZ-40-300-VA | 300          | 550               | 5,000                    |
| GZ-40-400-VA | 400          | 700               | 5,000                    |
| GZ-40-500-VA | 500          | 850               | 5,000                    |
| GZ-40-600-VA | 600          | 1,000             | 5,000                    |

**Ordering Example**

**GZ-40-150-EE-800-VA**

Type (Pull Type) \_\_\_\_\_

Body Ø (40 mm) \_\_\_\_\_

Stroke (150 mm) \_\_\_\_\_

Piston Rod End Fitting E14-VA \_\_\_\_\_

Body End Fitting E14-VA \_\_\_\_\_

Traction Force F<sub>1</sub> 800 N \_\_\_\_\_

Material (1.4301/1.4305, AISI 304/303, VA) \_\_\_\_\_

Mounting accessories see from page 208.

**Rod Shroud W14-40-VA**

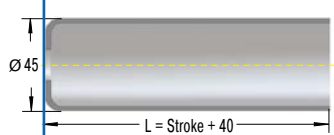

**Adjuster Knob DE-GAS-14**

See page 175.

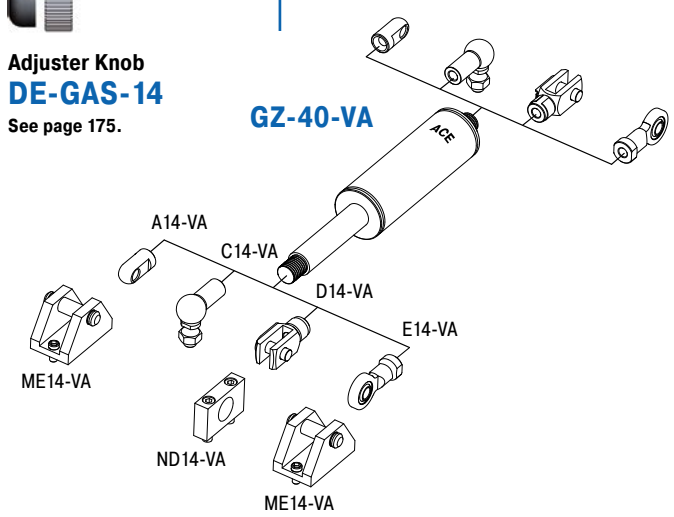

**Technical Data**

- Traction force:** 500 N to 5,000 N (extended up to 7,250 N)
- Progression:** Approx. 43 % to 45 %
- Lifetime:** Approx. 2,000 m
- Operating temperature range:** -20 °C to +80 °C
- Material:** Outer body, Piston rod, End fittings: stainless steel (1.4301/1.4305, AISI 304/303)
- Mounting:** with piston rod upwards
- End position damping length:** Without damping. For end position damping use damping material (e.g. TUBUS or SLAB).
- Positive stop:** External positive stop in the pulling direction provided by the customer.
- End fittings:** They are interchangeable and if necessary must be positively secured by the customer to prevent unscrewing.

## Stainless Steel Gas Springs (Pull Type), V4A

| TYPES         | Stroke<br>mm | L retracted<br>mm | Dimensions<br>see Page |
|---------------|--------------|-------------------|------------------------|
| GZ-19-30-V4A  | 30           | 130               | 168                    |
| GZ-19-50-V4A  | 50           | 150               | 168                    |
| GZ-19-100-V4A | 100          | 200               | 168                    |
| GZ-19-150-V4A | 150          | 250               | 168                    |
| GZ-19-200-V4A | 200          | 300               | 168                    |
| GZ-19-250-V4A | 250          | 350               | 168                    |
| GZ-28-50-V4A  | 50           | 165               | 169                    |
| GZ-28-100-V4A | 100          | 215               | 169                    |
| GZ-28-150-V4A | 150          | 265               | 169                    |
| GZ-28-200-V4A | 200          | 315               | 169                    |
| GZ-28-250-V4A | 250          | 365               | 169                    |
| GZ-28-300-V4A | 300          | 415               | 169                    |
| GZ-28-350-V4A | 350          | 465               | 169                    |
| GZ-28-400-V4A | 400          | 515               | 169                    |
| GZ-28-450-V4A | 450          | 565               | 169                    |
| GZ-28-500-V4A | 500          | 615               | 169                    |
| GZ-28-550-V4A | 550          | 665               | 169                    |
| GZ-28-600-V4A | 600          | 715               | 169                    |
| GZ-40-100-V4A | 100          | 250               | 170                    |
| GZ-40-150-V4A | 150          | 325               | 170                    |
| GZ-40-200-V4A | 200          | 400               | 170                    |
| GZ-40-250-V4A | 250          | 475               | 170                    |
| GZ-40-300-V4A | 300          | 550               | 170                    |
| GZ-40-400-V4A | 400          | 700               | 170                    |
| GZ-40-500-V4A | 500          | 850               | 170                    |
| GZ-40-600-V4A | 600          | 1,000             | 170                    |

## Stainless Steel Accessories, V4A

| TYPES   | Dimensions<br>see Page |
|---------|------------------------|
| A5-V4A  | 210                    |
| C5-V4A  | 210                    |
| D5-V4A  | 210                    |
| E5-V4A  | 210                    |
| G5-V4A  | 210                    |
| A8-V4A  | 211                    |
| C8-V4A  | 211                    |
| D8-V4A  | 211                    |
| E8-V4A  | 211                    |
| G8-V4A  | 212                    |
| A10-V4A | 212                    |
| C10-V4A | 212                    |
| D10-V4A | 212                    |
| E10-V4A | 212                    |
| A14-V4A | 213                    |
| C14-V4A | 213                    |
| D14-V4A | 213                    |
| E14-V4A | 213                    |

## Free Calculation Offer for Industrial Gas Springs

### With all necessary information for installation

To obtain the optimum operation with minimal hand force, the gas spring must be properly sized and the mounting points have to be optimally placed.

**It is important to identify the following points:**

- gas spring size
- required gas spring stroke
- mounting points on flap and frame
- extended length of the gas spring
- required extension force
- hand forces throughout the complete movement on the flap

With our free calculation service you can eliminate the time-consuming calculation and send us your details by fax or e-mail. Just complete the information shown on the following page. Please attach a sketch of your application (a simple hand sketch is sufficient) in side view. Our application engineers will determine the optimum gas springs and mounting points and calculate the ideal situation to satisfy your requirements. You will receive a quotation showing the opening and closing forces and our recommended mounting points to suit your application.



### Example of a Calculation Offer

| Input data      |                    | Identification data |          |
|-----------------|--------------------|---------------------|----------|
| Start angle     | $\alpha M$ : 270 ° | Temperature         | : 20 °C  |
| Open angle      | $\alpha$ : 105 °   | Progression         | : 42 %   |
| Rd. ctr.grvty.  | RM: 410 mm         | Friction            | : 30 N   |
| Mass            | m: 12 kg           | Ext. length         | : 504 mm |
| No. gas springs | n: 2               |                     |          |
| Radius handfor  | RR: 820 mm         |                     |          |

**Required user hand-forces**

F1-F2/F3-F4=Hand forces for opening/closing  
 Angle [°] F1-F2 [N] F3-F4 [N] Length [mm]

|     |     |     |     |
|-----|-----|-----|-----|
| 270 | -13 | -14 | 311 |
| 293 | 37  | 42  | 323 |
| 317 | 59  | 68  | 363 |
| 340 | 53  | 63  | 418 |
| 363 | 34  | 44  | 477 |
| 375 | 25  | 34  | 504 |

F1-F4 positive requires clockwise hand force  
 F1-F4 negative requires counter-clockwise hand force

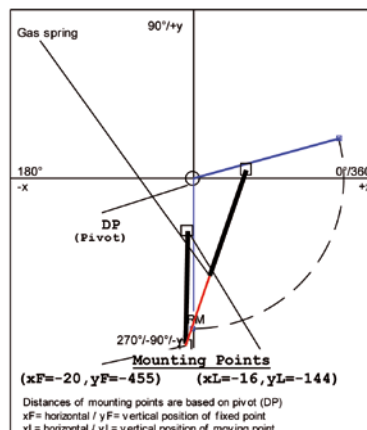

### Input Data

Gas Spring Push type  Gas Spring Pull type

#### Gas spring fixing points

The fixed point of the frame and the moving point of the flap are critical for the optimum operation.

Therefore please attach a sketch of your application!  
(A few lines with their dimensions are sufficient)

Moving mass\* m \_\_\_\_\_ kg  
 Number of gas springs in parallel\* n \_\_\_\_\_ pcs  
 Number of movements\* \_\_\_\_\_ /day  
 Ambient temperature T \_\_\_\_\_ °C

#### If not shown by the sketch:

Radius of centre of gravity  $R_M$  \_\_\_\_\_ mm  
 Radius of hand force  $R_H$  \_\_\_\_\_ mm  
 Starting angle  $\alpha_M$  \_\_\_\_\_ °  
 Opening angle  $\alpha$  \_\_\_\_\_ °

\* Compulsory information

### Desired Mounting Fittings

#### End Fitting

- |                            |                                |                            |
|----------------------------|--------------------------------|----------------------------|
| <input type="checkbox"/> A |                                | <input type="checkbox"/> A |
| <input type="checkbox"/> B | <b>B Stud Thread</b><br>       | <input type="checkbox"/> B |
| <input type="checkbox"/> C | <b>C Angle Ball Joint</b><br>  | <input type="checkbox"/> C |
| <input type="checkbox"/> D | <b>D Clevis Fork</b><br>       | <input type="checkbox"/> D |
| <input type="checkbox"/> E | <b>E Swivel Eye</b><br>        | <input type="checkbox"/> E |
| <input type="checkbox"/> F | <b>F Inline Ball Joint</b><br> | <input type="checkbox"/> F |
| <input type="checkbox"/> G | <b>G Ball Socket</b><br>       | <input type="checkbox"/> G |

The end fittings are interchangeable

e.g. -CE: C = Angle Ball Joint, E = Swivel Eye

#### Hood

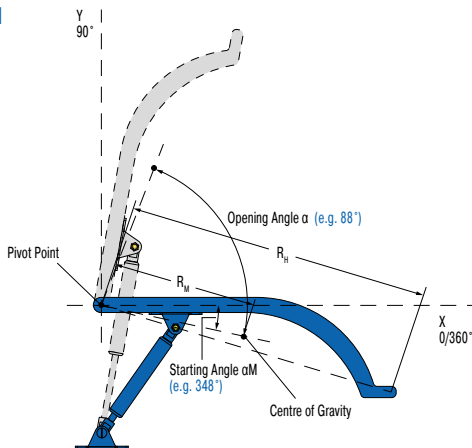

#### Flap

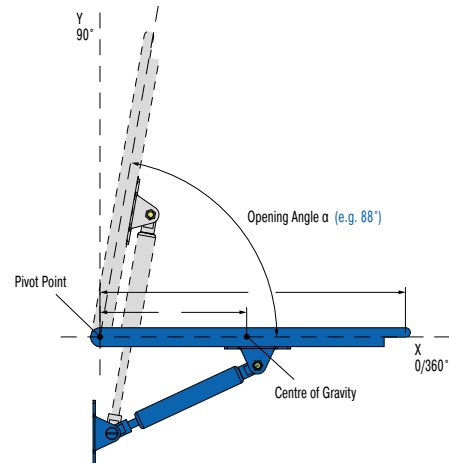

Please send us a sketch with dimensions of your application!  
Without this sketch we won't be able to calculate.

|                          |  |
|--------------------------|--|
| Comments                 |  |
| Requirement per year     |  |
| Machine type / reference |  |

#### Sender

|            |  |           |  |
|------------|--|-----------|--|
| Company    |  | Dept.     |  |
| Address    |  | Name      |  |
| ZIP / City |  | Telephone |  |
| Internet   |  | E-Mail    |  |

Please copy, complete and fax with attached sketch to: +49 (0)2173 - 9226-89

## Mounting and Safety Instructions

### Filling

Gas springs are filled with pure nitrogen gas. Nitrogen is an inert gas that does not burn or explode and is not poisonous. The internal pressure of gas springs can be up to 300 bar. Do not attempt to open or modify them!

### Gas springs are maintenance-free!

ACE gas springs will operate in surrounding temperatures from -20 °C to +80 °C.

We can equip our springs with special seals to withstand temperatures as low as -45 °C or as high as +200 °C.

Gas springs should not be placed over heat or in open fire!

ACE gas springs can be stored in any position. Pressure lost through long storage is not to be expected. There are no known negative values, but there may be a sticking effect the first time you compress a spring. This may require a higher initial force to operate the gas spring for the first time (initial breakaway force).

### Mounting

Gas springs should be installed with the piston rod downwards. This position ensures best damping quality. ACE gas springs include an integrated grease chamber which allows for alternative mounting opportunities.

The tolerance for the installation length is generally deemed to be  $\pm 2$  mm. If very high demands are placed on durability and stability, please avoid the combination of small diameter + long stroke + high force.

The filling tolerance is -20 N to 40 N or 5 % to 7 %. Depending on size and extension force the tolerances can differ.

### Life Time

Generally, ACE gas springs are tested to 70,000 to 100,000 complete strokes. This is equivalent to the seal lifetime (depending on model size) to a distance travelled of 10 km (lifetime of traction gas springs approx. 2 km). During these tests the gas spring must not lose more than 5 % of its pressure. Depending upon the application and operating environment, the service life of these gas springs may be much longer. In practise 500,000 strokes or more have been achieved on some applications.

### Disposal/Recycling

Please ask for our disposal recommendations.

## Warnings and Liability

All gas springs are marked with the part number, the production date and a warning sign "Do not open high pressure".

We are not responsible for any damages of any kind that arises due to goods that are not marked accordingly.

## Valve Actuation with ACE DE-GAS

### Simple, safe and reliable

#### De-gassing for controlled force reduction on valve gas springs

The reduction is made by screwing the DE-Gas on the male screwed end of the gas spring. The drain process is possible through light actuation of the push button. If too much nitrogen is discharged, the gas spring can be refilled by ACE.

#### Adjustment

1. Hold gas spring valve up.
2. Insert DE-GAS adjuster knob on thread of the valve.
3. Press the DE-GAS adjuster knob with light hand force until you can hear the nitrogen escaping. Press only briefly to avoid too much nitrogen being discharged.
4. After adjustment, remove the DE-GAS adjuster knob, mount the end fittings and test the gas spring in your application. If necessary repeat the procedure.

If you use 2 gas springs in parallel, both gas springs should have the same force to avoid bending forces or side load on the application. If necessary return to ACE to refill both gas springs to the same (average) force.

If too much nitrogen is discharged, the units can be returned to ACE for re-gassing.



DE-GAS

You can also visit our Youtube channel at [www.youtube.com/user/acecontrolsglobal](http://www.youtube.com/user/acecontrolsglobal)  
Here, among other things you will find an ACETips-Video on the topic of DE-GAS!

## Gas Spring Refilling Kit

### Flexible and easy to use

The ACE gas spring refilling kit offers you the opportunity to fill gas springs on location or adapt them individually. The refilling kit is equipped with all the parts you need to fill gas springs. Very precise filling of the gas springs is possible using the digital manometer. The table for determining the filling pressure of the gas springs is included with the case. The only thing missing from the delivery is the nitrogen.



The refilling kit contains all filling bells and adjuster knobs for the current ACE gas spring range.

Gas springs filled with the refilling kit must be measured on a calibrated measurement system by ACE for repeat production.

The refilling kit suits 200 bar nitrogen bottles with a thread of W24,32x1/14" (German standard). Other connections are available upon request.

Part number: **GS-FK-C**



# Hydraulic Dampers

## Multi-talent in speed control

The hydraulic dampers are similar in appearance to the ACE industrial gas springs but are adjusted in the end position and work differently to the DVC family with individual speed adjusters for the push and pull direction. This provide users with the maximum flexibility.

Whether used as drive compensation or safety elements, the retraction and extension speed of these ACE solutions can always be precisely set. This means that the speed of movement can be controlled, synchronisation regulated in both directions and pivoting loads can be compensated. Depending on the model, the push and pull forces are between 30 N and 40,000 N. These maintenance-free, ready-to-install products are available in body diameters of 12 mm to 70 mm and in stroke lengths up to 800 mm.



## Hydraulic Dampers



### DVC-32

Page 178

Adjustable, Without Free Travel

**Individual speed adjustment in both directions**

Cylinder speed controls, Absorption control, Finishing and processing centres



### HBD-50 to HBD-85

Page 180

Adjustable, Without Free Travel

**Regulation at the highest level**

Sports equipment, Rehabilitation technology, Conveyor technology



### HBS-28 to HBS-70

Page 184

Adjustable, Without Free Travel

**Direction change backlash free linear motion regulation**

Oscillation insulation, Chairlift impact control, Fairground rides, Cylinder speed controls



### HB-12 to HB-70

Page 188

Adjustable

**Linear motion control**

Conveyor systems, Transport systems, Furniture industry, Locking systems

## Door Dampers



### TD, TDE

Page 196

Adjustable

**The safe way to close doors**

Lift doors, Automatic doors, Doors

Constant speed rates

Sensitive adjustment

High quality and long lifetime

Easy to mount



## DVC-32

### Individual speed adjustment in both directions

#### Adjustable, Without Free Travel

**Compression and extension force 42 N to 2,000 N**

**Stroke 50 mm to 150 mm**

Can be regulated separately in any stroke position: The hydraulic dampers in the DVC-32 model are the first model to have the ability to have the in and out speeds adjusted independently from the outside and therefore more precisely. With their individual adjustment segments for the push and pull direction as well as the double-sided action, these are suitable as safety or control elements.

The great number of mounting accessories makes assembly of these hydraulic dampers by ACE easier and allows these maintenance-free, ready-to-install and self-contained systems universally applicable. Qualitatively high grade, and at the same time simple to use; one of their uses is to absorb swinging loads.

These machine elements are used, for one, in the automotive sector and industrial applications as well as in mechanical engineering and the electronics industry.

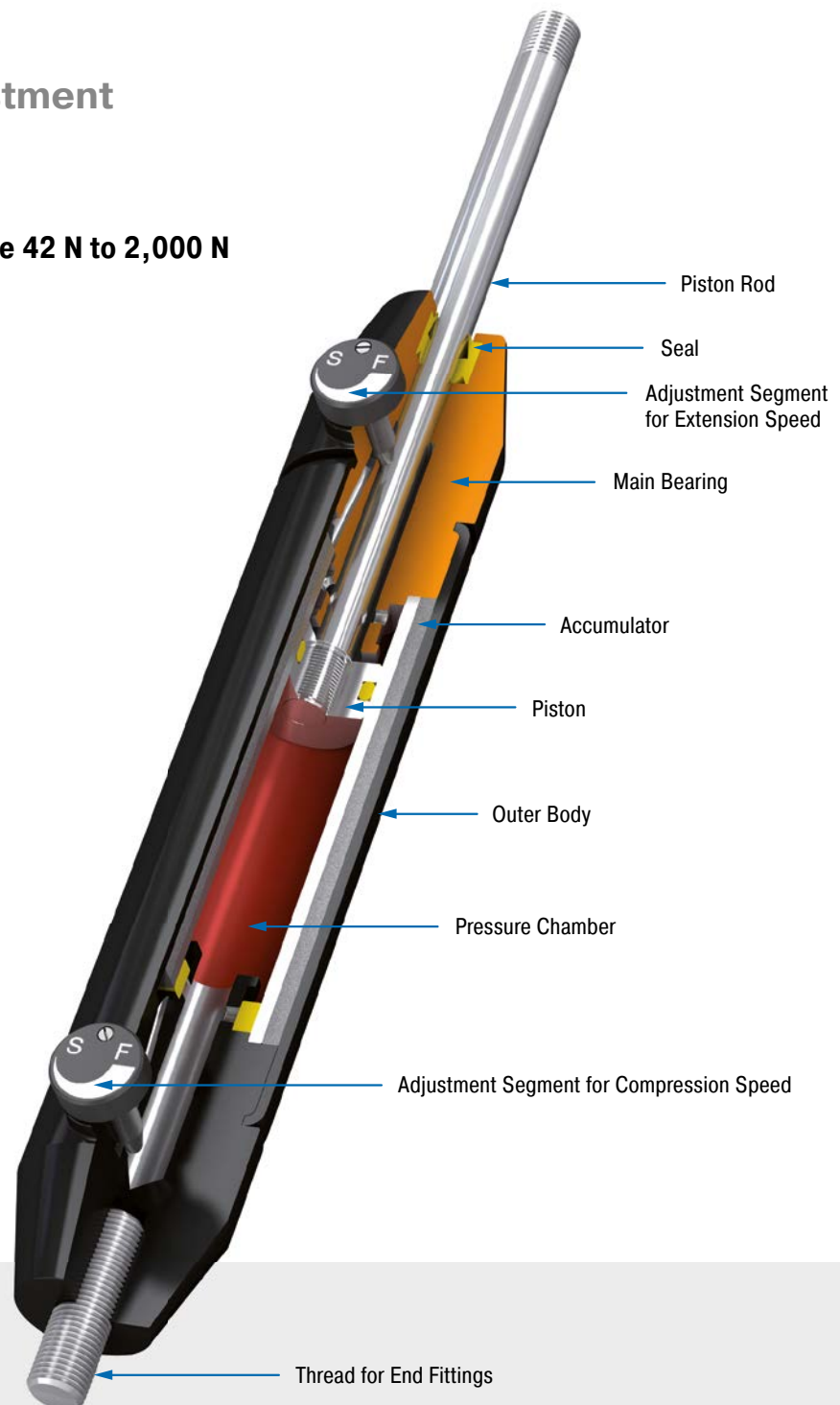

#### Technical Data

**Compression and extension force:** 42 N to 2,000 N

**Outer body diameter:** Ø 32 mm

**Piston rod diameter:** Ø 8 mm

**Lifetime:** Approx. 10,000 m

**Operating temperature range:** 0 °C to 65 °C

**Adjustment:** Steplessly adjustable

**Positive stop:** External positive stops 1 mm to 1.5 mm before the end of stroke provided by the customer.

**Damping medium:** Automatic Transmission Fluid (ATF)

**Material:** Outer body: Coated aluminium; Piston rod: Hard chrome plated steel; End fittings: Zinc plated steel

**Mounting:** In any position

**Application field:** Cylinder speed controls, Absorption control, Finishing and processing centres

**Note:** Increased break-away force if unit has not moved for some time. Damping force can be adjusted after installation.

**End fittings:** They are interchangeable and if necessary must be positively secured by the customer to prevent unscrewing.

**On request:** Special oils and other special options. Alternative accessories available on request.

Adjustable, Without Free Travel, Compression and extension force 42 N to 2,000 N

### End Fitting

### Standard Dimensions

### End Fitting

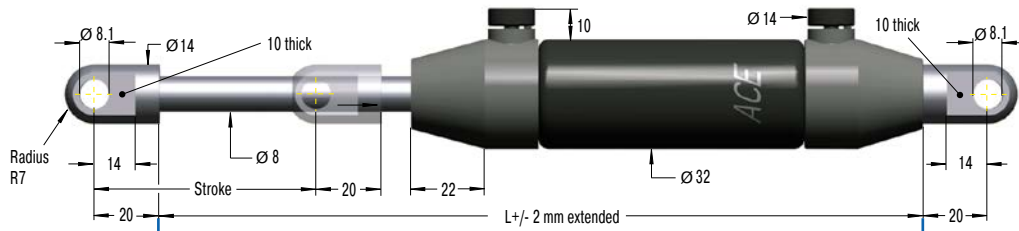
**A8**

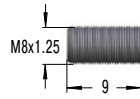
**Eye A8**  
max. force 3,000 N

**B8**

### Performance and Dimensions

| TYPES        | Stroke<br>mm | L extended<br>mm | <sup>1</sup> Compression force max.<br>N |
|--------------|--------------|------------------|--|
| DVC-32-50EU  | 50           | 240              | 2,000                                    |
| DVC-32-100EU | 100          | 340              | 1,670                                    |
| DVC-32-150EU | 150          | 440              | 1,335                                    |

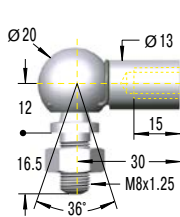
<sup>1</sup> Max. extension force for all stroke lengths 2,000 N.

**Stud Thread B8**
**C8**

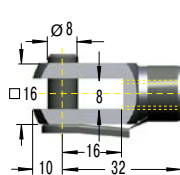
**Angle Ball Joint C8**  
max. force 1,200 N

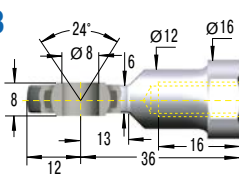
**D8**

**Clevis Fork D8**  
max. force 3,000 N

**E8**

**Swivel Eye E8**  
max. force 3,000 N

### Ordering Example

**DVC-32-50EU-DD-P**

Type (Hydraulic Damper) \_\_\_\_\_

Body Ø (32 mm) \_\_\_\_\_

Stroke (50 mm) \_\_\_\_\_

EU Compliant \_\_\_\_\_

Piston Rod End Fitting D8 \_\_\_\_\_

Body End Fitting D8 \_\_\_\_\_

Damping Direction (P = both directions) \_\_\_\_\_

### Model Type Prefix

P: Damping in both directions (standard model)  
 M: Damping on out stroke only (adjustment knob at "rear end" free flow)  
 N: Damping on in stroke only (adjustment knob at "piston rod end" free flow)

**End fittings:** They are interchangeable and if necessary must be positively secured by the customer to prevent unscrewing.

**Mounting accessories see from page 200.**

### DVC-32EU-xx

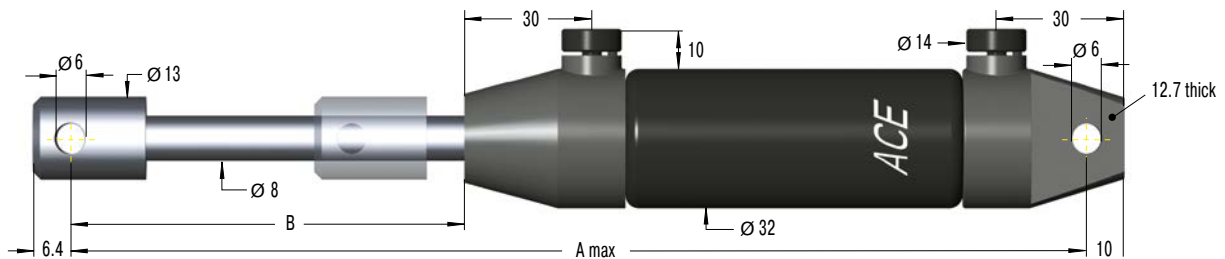

### Performance and Dimensions

| TYPES           | Stroke<br>mm | A max.<br>mm | B<br>mm | Compression force max.<br>N | Traction Force Range max.<br>N |
|-----------------|--------------|--------------|---------|-----------------------------|--------------------------------|
| DVC-32-50EU-XX  | 50           | 250          | 75.2    | 2,000                       | 2,000                          |
| DVC-32-100EU-XX | 100          | 350          | 124.4   | 1,670                       | 2,000                          |
| DVC-32-150EU-XX | 150          | 450          | 173.6   | 1,335                       | 2,000                          |

## HBD-50 to HBD-85

### Regulation at the highest level

#### Adjustable, Without Free Travel

**Compression and extension force 100 N to 50,000 N**

**Stroke 50 mm to 700 mm**

Motion control in both directions: The HBD model of hydraulic dampers can be adjusted independently in both the push and pull direction. These maintenance-free, ready-to-install and closed systems leave no prayers unanswered as far as the setting of retraction and extension speeds are concerned. In addition each damper works without any free travel therefore the flow of oil can be regulated exactly via the two precision metering orifices.

Adjustment can be made once installed and even when moving through stroke. The coated body and hard-chromed piston rods stand for quality and long service life. The variety of mounting accessories makes assembly easy and the high-end hydraulic dampers universally usable.

HBD hydraulic dampers are used in the automotive, in industry, mechanical engineering and medical technology.

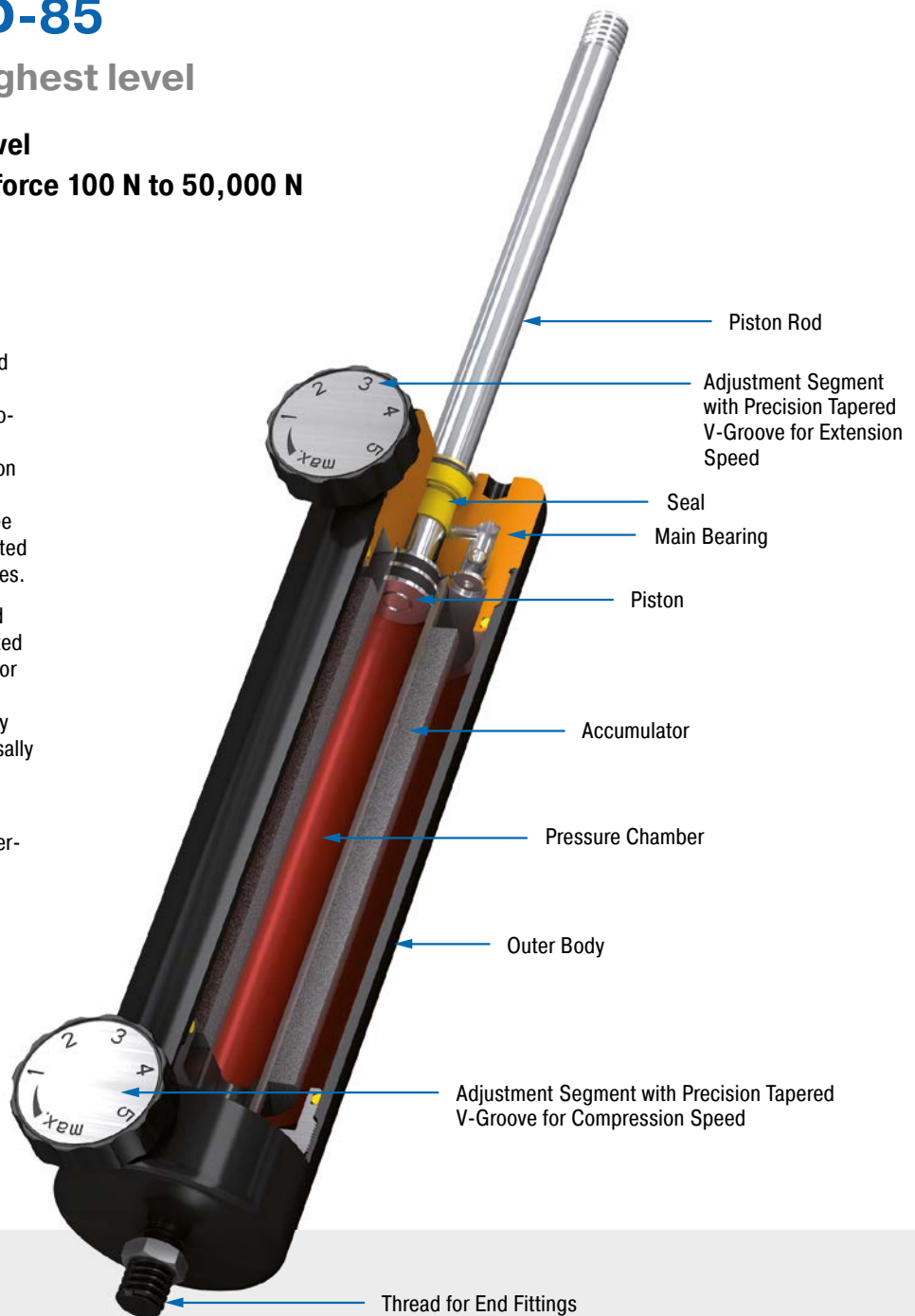

#### Technical Data

**Compression and extension force:** 100 N to 50,000 N

**Outer body diameter:** Ø 50 mm to Ø 85 mm

**Piston rod diameter:** Ø 10 mm to Ø 20 mm

**Lifetime:** Approx. 10,000 m

**Operating temperature range:** 0 °C to 65 °C

**Adjustment:** Steplessly adjustable

**Positive stop:** External positive stops 1 mm to 3 mm before the end of stroke provided by the customer.

**Damping medium:** hydraulic oil

**Material:** Outer body: coated steel; Piston rod: hard chrome plated steel; End fittings: zinc plated steel

**Mounting:** in any position

**Application field:** sports equipment, rehabilitation technology, conveyor technology

**Note:** Increased break-away force if unit has not moved for some time. One locknut included.

**End fittings:** They are interchangeable and if necessary must be positively secured by the customer to prevent unscrewing.

**On request:** Special oils and other special options. Alternative accessories available on request.

Adjustable, Without Free Travel, Compression and extension force 100 N to 6,000 N

### End Fitting

### Standard Dimensions

### End Fitting

**B10**

**A10**

**C10**

**D10**

**E10**

**Performance and Dimensions**

| TYPES      | Stroke<br>mm | L extended<br>mm | <sup>1</sup> Compression force max.<br>N |
|------------|--------------|------------------|--|
| HBD-50-50  | 50           | 192              | 6.000                                    |
| HBD-50-100 | 100          | 292              | 6.000                                    |
| HBD-50-150 | 150          | 392              | 4.400                                    |
| HBD-50-200 | 200          | 492              | 2.800                                    |
| HBD-50-250 | 250          | 592              | 2.000                                    |
| HBD-50-300 | 300          | 692              | 1.400                                    |

<sup>1</sup> Max. extension force for all stroke lengths 6,000 N.

**Ordering Example**

**HBD-50-150-EE**

Type (Hydraulic Damper) \_\_\_\_\_

Body Ø (50 mm) \_\_\_\_\_

Stroke (150 mm) \_\_\_\_\_

Piston Rod End Fitting E10 \_\_\_\_\_

Body End Fitting E10 \_\_\_\_\_

**Model Type Prefix**

P: Damping in both directions (standard model)  
 M: Damping on out stroke only (adjustment knob at "rear end" free flow)  
 N: Damping on in stroke only (adjustment knob at "piston rod end" free flow)

**Mounting accessories see from page 200.**

**Stud Thread B10**

**Eye A10**  
max. force 10,000 N

**Angle Ball Joint C10**  
max. force 1,800 N

**Clevis Fork D10**  
max. force 10,000 N

**Swivel Eye E10**  
max. force 10,000 N

Issue 07.2017 – Specifications subject to change

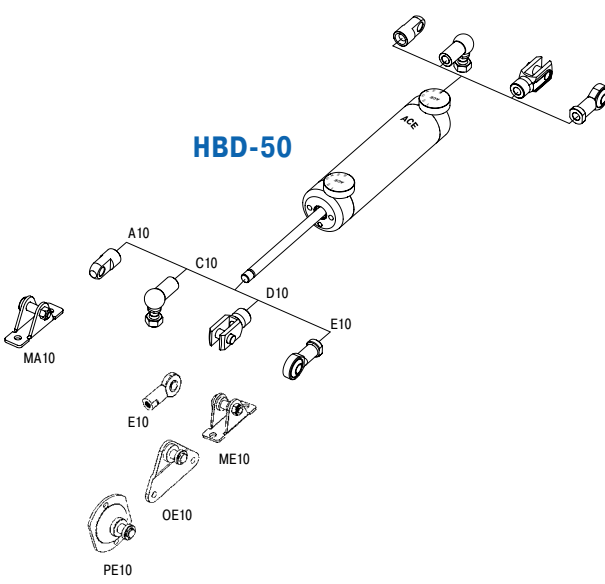

### Technical Data

- Compression and extension force:** 100 N to 6,000 N
- Operating temperature range:** 0 °C to 65 °C
- Adjustment:** Steplessly adjustable
- Positive stop:** External positive stops 1 mm to 1.5 mm before the end of stroke provided by the customer.
- Material:** Outer body: Coated steel; Piston rod: Hard chrome plated steel; End fittings: Zinc plated steel
- Mounting:** In any position
- Note:** Increased break-away force if unit has not moved for some time. One locknut included.
- End fittings:** They are interchangeable and if necessary must be positively secured by the customer to prevent unscrewing.



Adjustable, Without Free Travel, Compression and extension force 150 N to 10,000 N

End Fitting

Standard Dimensions

End Fitting

**B14** Stud Thread **B14**

**A14** Eye **A14**  
max. force 10,000 N

**C14** Angle Ball Joint **C14**  
max. force 3,200 N

**D14** Clevis Fork **D14**  
max. force 10,000 N

**E14** Swivel Eye **E14**  
max. force 10,000 N

**Performance and Dimensions**

| TYPES      | Stroke<br>mm | L extended<br>mm | <sup>1</sup> Compression force max.<br>N |
|------------|--------------|------------------|--|
| HBD-70-100 | 100          | 306              | 10,000                                   |
| HBD-70-150 | 150          | 406              | 10,000                                   |
| HBD-70-200 | 200          | 506              | 10,000                                   |
| HBD-70-300 | 300          | 706              | 10,000                                   |
| HBD-70-400 | 400          | 906              | 8,000                                    |
| HBD-70-500 | 500          | 1,106            | 6,000                                    |

<sup>1</sup> Max. extension force for all stroke lengths 10,000 N.

**Ordering Example**

**HBD-70-300-EE**

Type (Hydraulic Damper) \_\_\_\_\_  
 Body Ø (70 mm) \_\_\_\_\_  
 Stroke (300 mm) \_\_\_\_\_  
 Piston Rod End Fitting E14 \_\_\_\_\_  
 Body End Fitting E14 \_\_\_\_\_

**Model Type Prefix**

P: Damping in both directions (standard model)  
 M: Damping on out stroke only (adjustment knob at "rear end" free flow)  
 N: Damping on in stroke only (adjustment knob at "piston rod end" free flow)

**Mounting accessories see from page 200.**

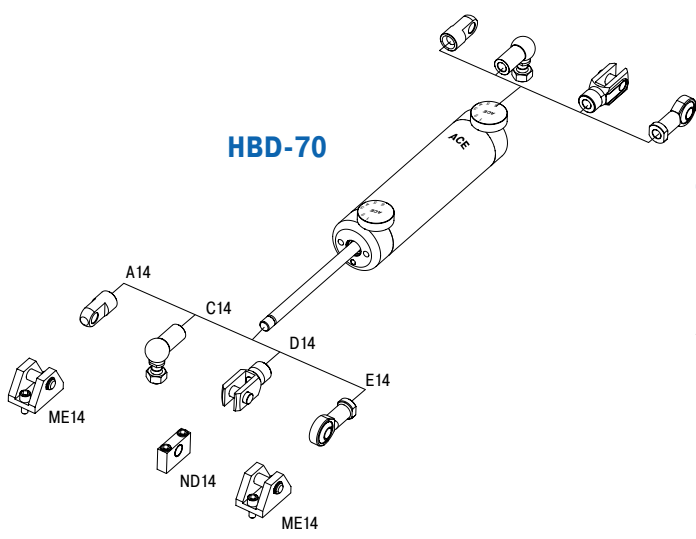

Technical Data

- Compression and extension force:** 150 N to 10,000 N
- Operating temperature range:** 0 °C to 65 °C
- Adjustment:** Steplessly adjustable
- Positive stop:** External positive stops 1 mm to 1.5 mm before the end of stroke provided by the customer.
- Material:** Outer body: Coated steel; Piston rod: Hard chrome plated steel; End fittings: Zinc plated steel
- Mounting:** In any position
- Note:** Increased break-away force if unit has not moved for some time. One locknut included.
- End fittings:** They are interchangeable and if necessary must be positively secured by the customer to prevent unscrewing.

Adjustable, Without Free Travel, Compression and extension force 150 N to 50,000 N

### End Fitting

### Standard Dimensions

### End Fitting

**B24** M24x2 Thread Adaptor

**D24** Clevis Fork **D24** max. force 50,000 N

**E24** Swivel Eye **E24** max. force 50,000 N

Dimensions: 28, 14, Ø 46, 17, Ø 20, Stroke, L +/- 2 mm extended, Ø 85, 35

| Performance and Dimensions |              |                  |  |
|----------------------------|--------------|------------------|--|
| TYPES                      | Stroke<br>mm | L extended<br>mm | <sup>1</sup> Compression force max.<br>N |
| HBD-85-100                 | 100          | 313              | 50,000                                   |
| HBD-85-150                 | 150          | 413              | 30,000                                   |
| HBD-85-200                 | 200          | 513              | 20,000                                   |
| HBD-85-300                 | 300          | 713              | 10,000                                   |
| HBD-85-400                 | 400          | 913              | 6,500                                    |
| HBD-85-500                 | 500          | 1,113            | 4,000                                    |
| HBD-85-600                 | 600          | 1,313            | 3,000                                    |
| HBD-85-700                 | 700          | 1,513            | 2,000                                    |

<sup>1</sup> Max. extension force for all stroke lengths 50,000 N.

**Ordering Example**  
**HBD-85-300-EE**  
 Type (Hydraulic Damper) \_\_\_\_\_  
 Body Ø (85 mm) \_\_\_\_\_  
 Stroke (300 mm) \_\_\_\_\_  
 Piston Rod End Fitting E24 \_\_\_\_\_  
 Body End Fitting E24 \_\_\_\_\_

**Model Type Prefix**  
 P: Damping in both directions (standard model)  
 M: Damping on out stroke only (adjustment knob at "rear end" free flow)  
 N: Damping on in stroke only (adjustment knob at "piston rod end" free flow)

**Mounting accessories see from page 200.**

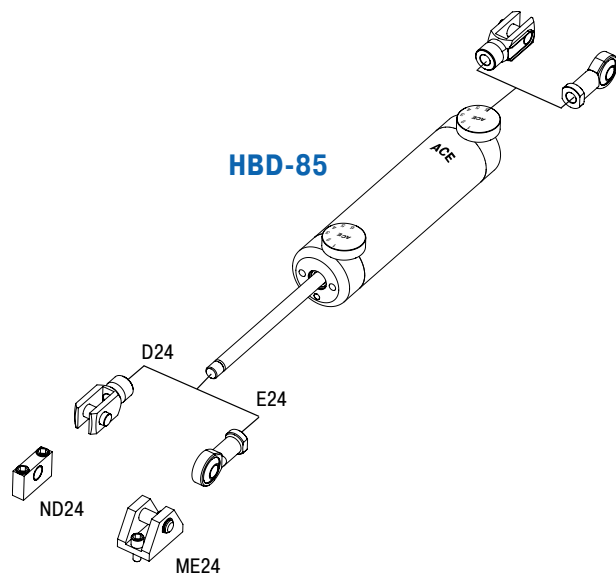

### Technical Data

**Compression and extension force:** 150 N to 50,000 N

**Operating temperature range:** 0 °C to 65 °C

**Adjustment:** Steplessly adjustable

**Positive stop:** External positive stops 2 mm to 3 mm before the end of stroke provided by the customer.

**Material:** Outer body: Coated steel; Piston rod: Hard chrome plated steel; End fittings: Zinc plated steel

**Mounting:** In any position

**Note:** Increased break-away force if unit has not moved for some time. Thread adaptor for piston rod from M16 to M24 included.

**End fittings:** They are interchangeable and if necessary must be positively secured by the customer to prevent unscrewing.

## HBS-28 to HBS-70

### Direction change backlash free linear motion regulation

#### Adjustable, Without Free Travel

**Compression and extension force 30 N to 40,000 N**

**Stroke 50 mm to 800 mm**

Damping either in one or both directions: The HBS models of hydraulic dampers are made in a slim gas spring design and are compact and high in performance. Maintenance-free and ready-to-install they allow precise setting of retraction and extension speeds without any free travel when changing direction.

These hydraulic dampers offer constant feeding rates and can be finely tuned via the screw adjustment. A control segment on the piston makes the adjustment at the end position child's play. Thanks to many add-on components the assembly is easy to mount, so that the damper can be universally deployed for damping back and forth swinging masses, such as in power or free conveyors.

In addition to the automotive sector, the application areas are industrial applications, classic mechanical engineering, the electronics and furniture industry and medical technology.

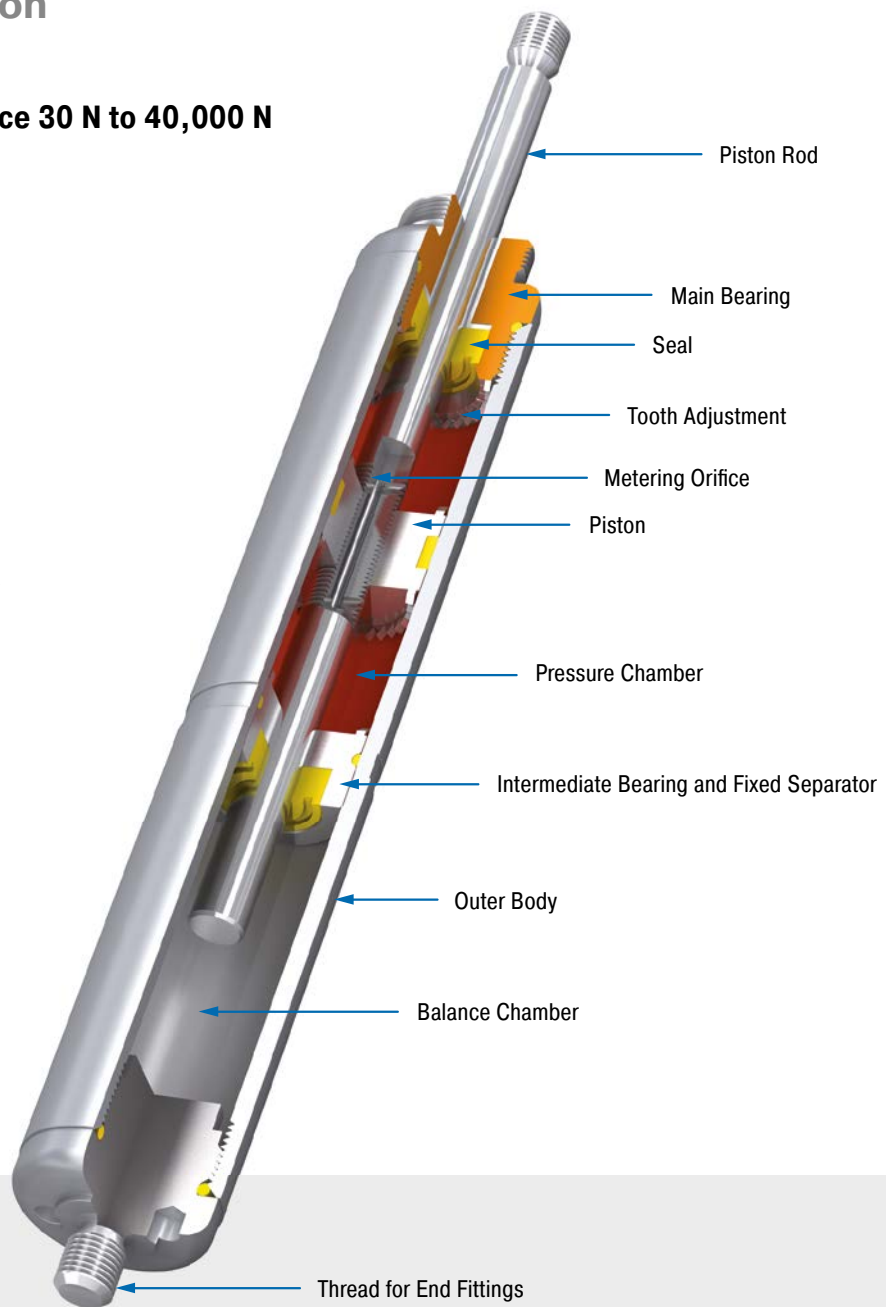

#### Technical Data

**Compression and extension force:** 30 N to 40,000 N

**Outer body diameter:** Ø 28 mm to Ø 70 mm

**Piston rod diameter:** Ø 8 mm to Ø 30 mm

**Lifetime:** Approx. 10,000 m

**Operating temperature range:** -20 °C to +80 °C

**Adjustment:** Achieved by turning the piston rod in its fully extended or compressed position.

**Positive stop:** External positive stops 1 mm to 6 mm before the end of stroke provided by the customer.

**Damping medium:** Hydraulic oil

**Material:** Outer body: Zinc plated or coated steel; Piston rod: Hard chrome plated steel; End fittings: Zinc plated steel

**Mounting:** In any position

**Application field:** Oscillation insulation, Chairlift impact control, Fairground rides, Cylinder speed controls, Absorption control

**Note:** Increased break-away force if unit has not moved for some time.

**End fittings:** They are interchangeable and if necessary must be positively secured by the customer to prevent unscrewing.

**Safety instructions:** For long strokes with high forces use swivel mounting block MBS.

**On request:** Special oils and other special options. Alternative accessories available on request.

Adjustable, Without Free Travel, Compression and extension force 30 N to 3,000 N

### End Fitting

### Standard Dimensions

### End Fitting

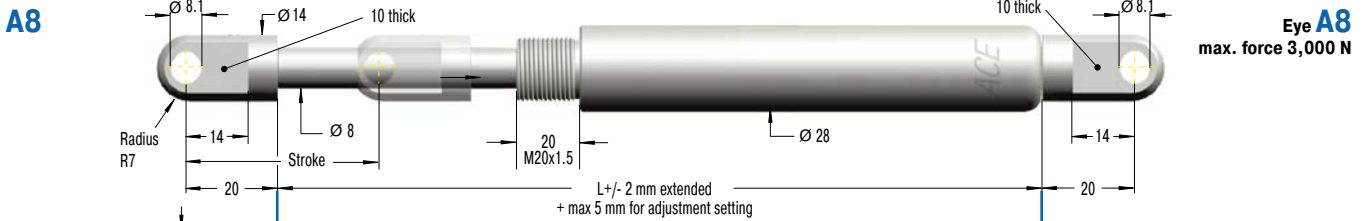

### B8

### Stud Thread B8

### C8

### Angle Ball Joint C8 max. force 1,200 N

### D8

### Clevis Fork D8 max. force 3,000 N

### E8

### Swivel Eye E8 max. force 3,000 N

### G8

### Ball Socket G8 max. force 1,200 N

### Rod Shroud no retrofit Ø 32, L = Stroke + 80

### Performance and Dimensions

| TYPES      | Stroke<br>mm | L extended<br>mm | <sup>1</sup> Compression force<br>max.<br>N | <sup>1</sup> Compression force<br>with MBS max.<br>N |
|------------|--------------|------------------|---|--|
| HBS-28-50  | 62           | 297              | 3,000                                       | 3,000  |
| HBS-28-100 | 112          | 447              | 1,550                                       | 3,000  |
| HBS-28-150 | 162          | 597              | 900   | 3,000  |
| HBS-28-200 | 212          | 747              | 600   | 3,000  |
| HBS-28-250 | 262          | 897              | 440   | 3,000  |
| HBS-28-300 | 312          | 1,047            | 330   | 3,000  |
| HBS-28-350 | 362          | 1,197            | 260   | 2,500  |
| HBS-28-400 | 412          | 1,347            | 200   | 2,000  |

<sup>1</sup> Max. extension force for all stroke lengths 3,000 N.

### Ordering Example

**HBS-28-150-DD-M**

Type (Hydraulic Damper) \_\_\_\_\_  
 Body Ø (28 mm) \_\_\_\_\_  
 Stroke (150 mm) \_\_\_\_\_  
 Piston Rod End Fitting D8 \_\_\_\_\_  
 Body End Fitting D8 \_\_\_\_\_  
 Damping Direction (M = out stroke only) \_\_\_\_\_

### Model Type Prefix

P: Damping in both directions  
 N: Damping on in stroke only  
 M: Damping on out stroke only  
 X: Special model suffix

Mounting accessories see from page 200.

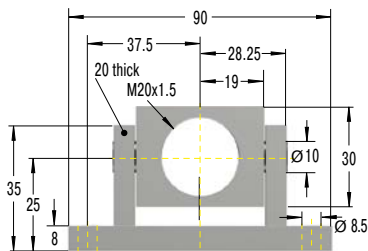

### Swivel Mounting Block MBS-28

### HBS-28

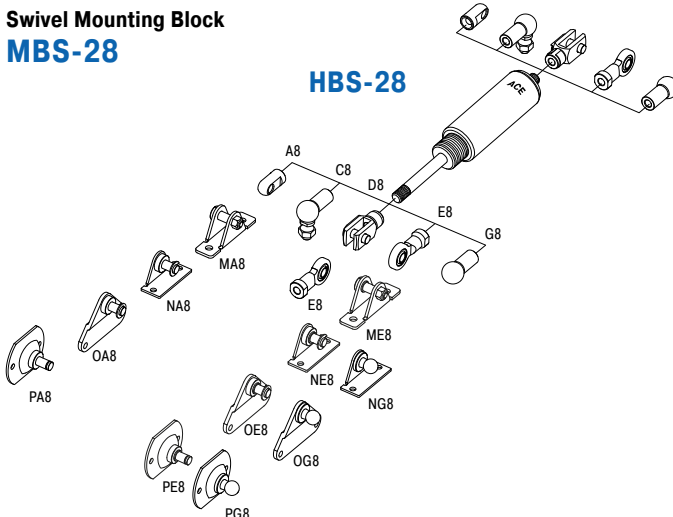

### Technical Data

**Compression and extension force:** 30 N to 3,000 N

**Operating temperature range:** -20 °C to +80 °C

**Adjustment:** Achieved by turning the piston rod in its fully extended or fully compressed position.

Clockwise rotation = increase of the damping

Anti-clockwise rotation = decrease of the damping

Damping force adjustable before installation. The adjustment can add a max. of 5 mm to the L dimension.

**Positive stop:** External positive stops 1 mm to 1.5 mm before the end of stroke provided by the customer.

**Material:** Outer body: Zinc plated or coated steel; Piston rod: Hard chrome plated steel; End fittings: Zinc plated steel

**Mounting:** In any position

**Note:** Increased break-away force if unit has not moved for some time.

**End fittings:** They are interchangeable and if necessary must be positively secured by the customer to prevent unscrewing.

**Safety instructions:** For long strokes with high forces use swivel mounting block MBS.

Adjustable, Without Free Travel, Compression and extension force 30 N to 10,000 N

End Fitting

Standard Dimensions

End Fitting

A10

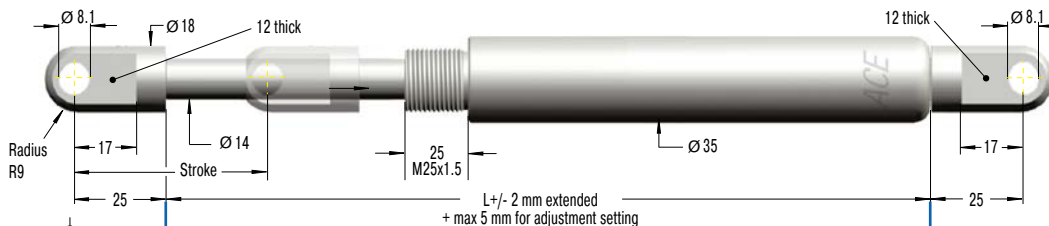

Eye A10  
max. force 10,000 N

B10

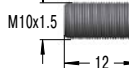

Stud Thread B10

C10

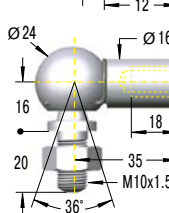

Angle Ball Joint C10  
max. force 1,800 N

D10

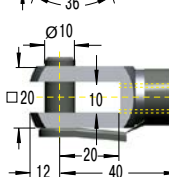

Clevis Fork D10  
max. force 10,000 N

E10

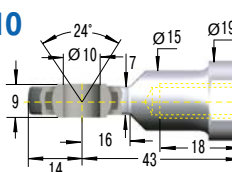

Swivel Eye E10  
max. force 10,000 N

Performance and Dimensions

| TYPES      | Stroke mm | L extended mm | <sup>1</sup> Compression force max. N | <sup>1</sup> Compression force with MBS max. N |
|------------|-----------|---------------|---------------------------------------|--|
| HBS-35-100 | 117       | 487           | 10,000                                | 10,000   |
| HBS-35-150 | 167       | 637           | 7,500                                 | 10,000   |
| HBS-35-200 | 217       | 787           | 5,150                                 | 10,000   |
| HBS-35-300 | 317       | 1,087         | 2,850                                 | 10,000   |
| HBS-35-400 | 417       | 1,387         | 1,800                                 | 10,000   |
| HBS-35-500 | 517       | 1,687         | 1,240                                 | 10,000   |
| HBS-35-600 | 617       | 1,987         | 910                                   | 8,600  |
| HBS-35-700 | 717       | 2,287         | 690                                   | 6,500  |
| HBS-35-800 | 817       | 2,587         | 540                                   | 5,100  |

<sup>1</sup> Max. extension force for all stroke lengths 10,000 N.

Ordering Example

HBS-35-300-EE-N

- Type (Hydraulic Damper) \_\_\_\_\_
- Body Ø (35 mm) \_\_\_\_\_
- Stroke (300 mm) \_\_\_\_\_
- Piston Rod End Fitting E10 \_\_\_\_\_
- Body End Fitting E10 \_\_\_\_\_
- Damping Direction (N = in stroke only) \_\_\_\_\_

Model Type Prefix

- P: Damping in both directions
- N: Damping on in stroke only
- M: Damping on out stroke only
- X: Special model suffix

Mounting accessories see from page 200.

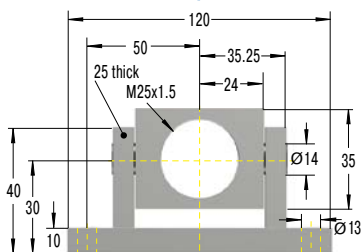

Swivel Mounting Block MBS-35

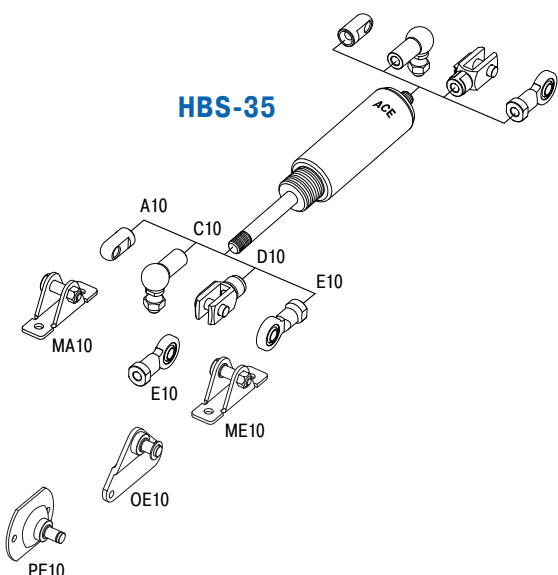

Technical Data

- Compression and extension force:** 30 N to 10,000 N
- Operating temperature range:** -20 °C to +80 °C
- Adjustment:** Achieved by turning the piston rod in its fully extended or fully compressed position.  
Clockwise rotation = increase of the damping  
Anti-clockwise rotation = decrease of the damping  
Damping force adjustable before installation. The adjustment can add a max. of 5 mm to the L dimension.
- Positive stop:** External positive stops 1 mm to 1.5 mm before the end of stroke provided by the customer.
- Material:** Outer body: Zinc plated or coated steel; Piston rod: Hard chrome plated steel; End fittings: Zinc plated steel
- Mounting:** In any position
- Note:** Increased break-away force if unit has not moved for some time.
- End fittings:** They are interchangeable and if necessary must be positively secured by the customer to prevent unscrewing.
- Safety instructions:** For long strokes with high forces use swivel mounting block MBS.



Adjustable, Without Free Travel, Compression and extension force 2,000 N to 40,000 N

### End Fitting

### Standard Dimensions

### End Fitting

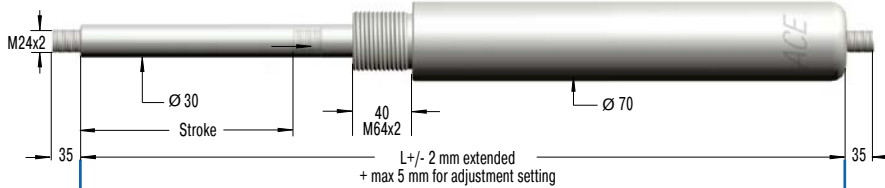
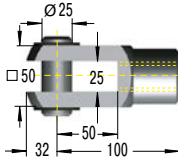
**B24**

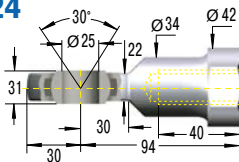
**Stud Thread B24**
**D24**

**Clevis Fork D24**  
max. force 50,000 N

**E24**

**Swivel Eye E24**  
max. force 50,000 N

#### Performance and Dimensions

| TYPES      | Stroke<br>mm | L extended<br>mm | <sup>1</sup> Compression force<br>max.<br>N | <sup>1</sup> Compression force<br>with MBS max.<br>N |
|------------|--------------|------------------|---|--|
| HBS-70-100 | 111          | 561              | 40,000                                      | 40,000   |
| HBS-70-200 | 211          | 861              | 40,000                                      | 40,000   |
| HBS-70-300 | 311          | 1,161            | 40,000                                      | 40,000   |
| HBS-70-400 | 411          | 1,461            | 30,300                                      | 40,000   |
| HBS-70-500 | 511          | 1,761            | 21,600                                      | 40,000   |
| HBS-70-600 | 611          | 2,061            | 16,200                                      | 40,000   |
| HBS-70-700 | 711          | 2,361            | 12,600                                      | 40,000   |
| HBS-70-800 | 811          | 2,661            | 10,100                                      | 40,000   |

<sup>1</sup> Max. extension force for all stroke lengths 40,000 N.

#### Ordering Example

**HBS-70-300-EE-N**

Type (Hydraulic Damper) \_\_\_\_\_

Body Ø (70 mm) \_\_\_\_\_

Stroke (300 mm) \_\_\_\_\_

Piston Rod End Fitting E24 \_\_\_\_\_

Body End Fitting E24 \_\_\_\_\_

Damping Direction (N = in stroke only) \_\_\_\_\_

#### Model Type Prefix

P: Damping in both directions  
N: Damping on in stroke only  
M: Damping on out stroke only  
X: Special model suffix

Mounting accessories see from page 200.

**Rod Shroud W24-70**  
Ø 80, L = Stroke + 180

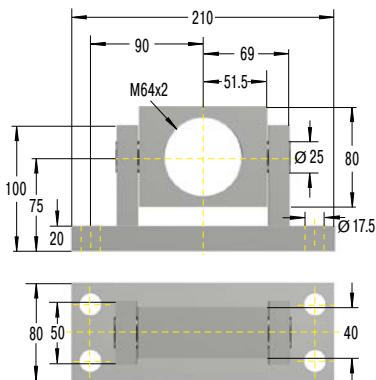

### Swivel Mounting Block MBS-70

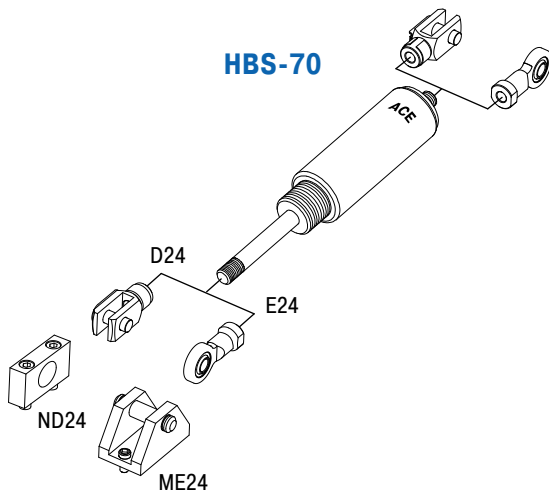

### Technical Data

**Compression and extension force:** 2,000 N to 40,000 N

**Operating temperature range:** -20 °C to +80 °C

**Adjustment:** Achieved by turning the piston rod in its fully extended or fully compressed position.

Clockwise rotation = increase of the damping

Anti-clockwise rotation = decrease of the damping

Damping force adjustable before installation. The adjustment can add a max. of 5 mm to the L dimension.

**Positive stop:** External positive stops 5 mm to 6 mm before the end of stroke provided by the customer.

**Material:** Outer body: Zinc plated or coated steel; Piston rod: Hard chrome plated steel; End fittings: Zinc plated steel

**Mounting:** In any position

**Note:** Increased break-away force if unit has not moved for some time.

**End fittings:** They are interchangeable and if necessary must be positively secured by the customer to prevent unscrewing.

**Safety instructions:** For long strokes with high forces use swivel mounting block MBS.



## HB-12 to HB-70

### Linear motion control

#### Adjustable

**Compression and extension force 20 N to 50,000 N**

**Stroke 10 mm to 800 mm**

High quality and long service life: The HB model of hydraulic damper can also be used as single or double acting brake. Its coated body in a slim gas spring design and the piston rods with wear-resistant surface coating are features of high quality and long service life.

The maintenance free, ready-to-install and closed systems provide a constant feed rate and are adjustable, and the control segment on the piston makes adjustment at the end position child's play. Thanks to many add-on components the assembly is easy to mount, so that the damper can be universally deployed for damping back and forth swinging masses, such as in power or free conveyors.

On automotive or industrial applications, mechanical engineering, medical technology or the electronics and furniture industry, these machine elements are found in a number of different areas.

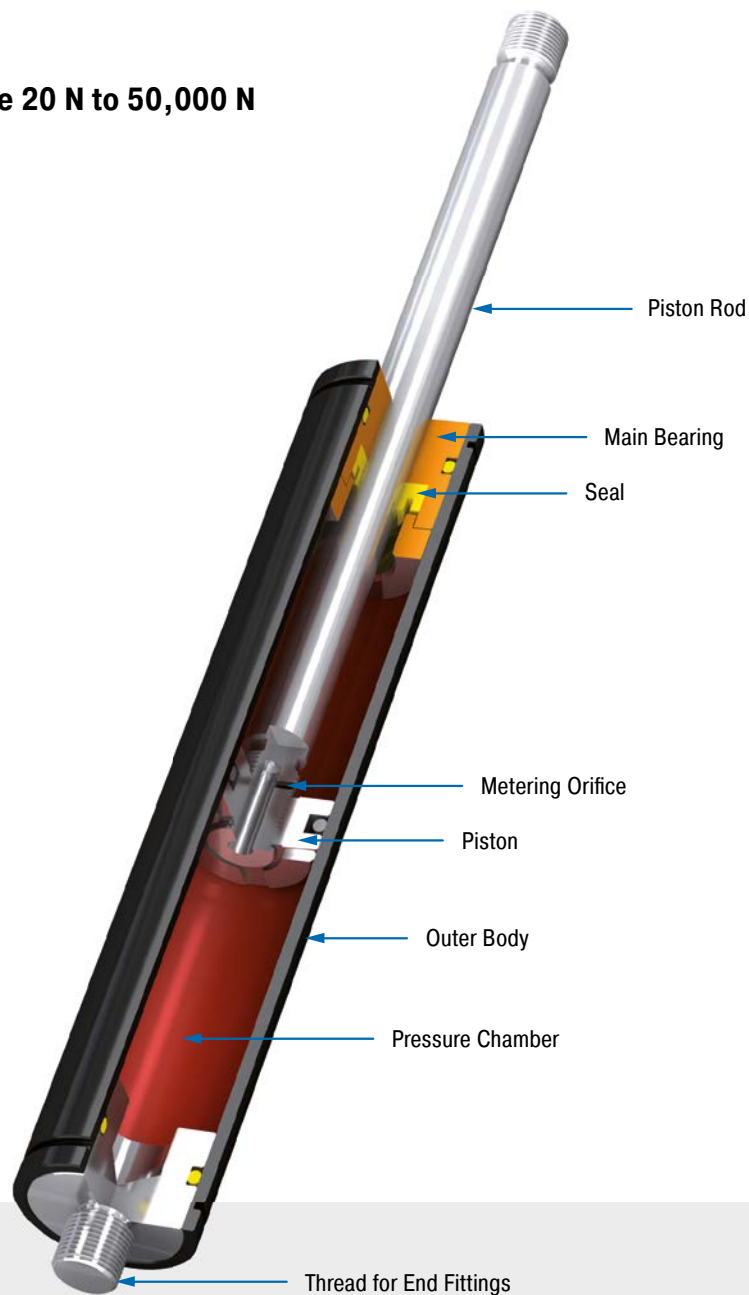

#### Technical Data

**Compression and extension force:** 20 N to 50,000 N

**Outer body diameter:** Ø 12 mm to Ø 70 mm

**Piston rod diameter:** Ø 4 mm to Ø 30 mm

**Lifetime:** Approx. 10,000 m

**Free travel:** Construction of the damper results in a free travel of approx. 20 % of stroke.

**Separator piston:** Available as a special option without free travel achieved by separator piston and nitrogen accumulator.

**Operating temperature range:** -20 °C to +80 °C

**Adjustment:** Achieved by turning the piston rod in its fully extended or fully compressed position.

**Positive stop:** External positive stops 1 mm to 6 mm before the end of stroke provided by the customer.

**Damping medium:** Hydraulic oil

**Material:** Outer body: Coated steel; Piston rod: Steel or stainless steel with wear-resistant coating; End fittings: Zinc plated steel

**Mounting:** In any position

**Application field:** Conveyor systems, Transport systems, Furniture industry, Locking systems, Sports equipment

**Note:** Increased break-away force if unit has not moved for some time.

**End fittings:** They are interchangeable and if necessary must be positively secured by the customer to prevent unscrewing.

**On request:** Special oils and other special options. Alternative accessories available on request.

Adjustable, Compression and extension force 20 N to 180 N

### End Fitting

### Standard Dimensions

### End Fitting

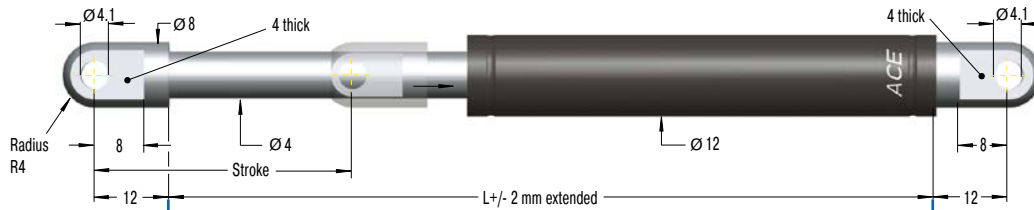
**A3,5**

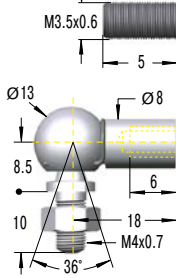
**Eye A3,5**  
max. force 370 N

**B3,5**
**C3,5**

### Performance and Dimensions

| TYPES    | Stroke mm | L extended mm | <sup>1</sup> Compression force max. N |
|----------|-----------|---------------|---------------------------------------|
| HB-12-10 | 10        | 55            | 180                                   |
| HB-12-20 | 20        | 75            | 180                                   |
| HB-12-30 | 30        | 95            | 180                                   |
| HB-12-40 | 40        | 115           | 180                                   |
| HB-12-50 | 50        | 135           | 180                                   |
| HB-12-60 | 60        | 155           | 180                                   |
| HB-12-70 | 70        | 175           | 180                                   |
| HB-12-80 | 80        | 195           | 150                                   |

<sup>1</sup> Max. extension force for all stroke lengths 180 N.

**Stud Thread B3,5**
**Angle Ball Joint C3,5**  
max. force 370 N

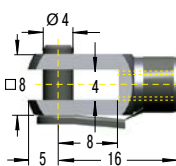
**D3,5**

### Ordering Example

Type (Hydraulic Damper) \_\_\_\_\_  
 Body Ø (12 mm) \_\_\_\_\_  
 Stroke (30 mm) \_\_\_\_\_  
 Piston Rod End Fitting A3,5 \_\_\_\_\_  
 Body End Fitting C3,5 \_\_\_\_\_  
 Damping Direction (M = out stroke only) \_\_\_\_\_

**HB-12-30-AC-M**

**Clevis Fork D3,5**  
max. force 370 N

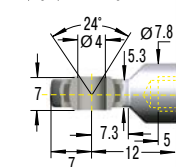
**E3,5**

### Model Type Prefix

P: Damping in both directions  
 N: Damping on in stroke only  
 M: Damping on out stroke only  
 X: Special model suffix

**Swivel Eye E3,5**  
max. force 370 N

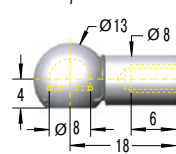
**G3,5**

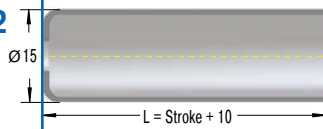
**Ball Socket G3,5**  
max. force 370 N

**Rod Shroud W3,5-12**

**Mounting accessories see from page 200.**

### Technical Data

**Compression and extension force:** 20 N to 180 N

**Free travel:** Construction of the damper results in a free travel of approx. 21 % of stroke.

**Separator piston:** -

**Operating temperature range:** -20 °C to +80 °C

**Adjustment:** Achieved by turning the piston rod in its fully extended or fully compressed position.

Clockwise rotation = increase of the damping

Anti-clockwise rotation = decrease of the damping

Damping force adjustable before installation. Adjustment can add a max. of 6 mm to the L dimension.

**Positive stop:** External positive stops 1 mm to 1.5 mm before the end of stroke provided by the customer.

**Material:** Outer body: coated steel; Piston rod: stainless steel (1.4301/1.4305, AISI 304/303); End fittings: zinc plated steel

**Mounting:** in any position

**Note:** Increased break-away force if unit has not moved for some time.

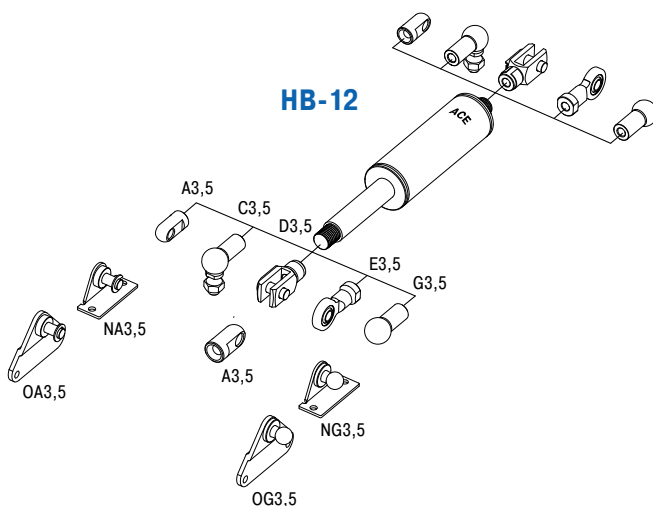
**End fittings:** They are interchangeable and if necessary must be positively secured by the customer to prevent unscrewing.

Adjustable, Compression and extension force 20 N to 800 N

End Fitting

Standard Dimensions

End Fitting

**A5** Eye A5 max. force 800 N

**B5** Stud Thread B5

**C5** Angle Ball Joint C5 max. force 500 N

**D5** Clevis Fork D5 max. force 800 N

**E5** Swivel Eye E5 max. force 800 N

**G5** Ball Socket G5 max. force 500 N

**Rod Shroud W5-15**

Dimensions:  $\varnothing 6.1$ ,  $\varnothing 10$ , 6 thick, Radius R5, 10, Stroke,  $\varnothing 6$ ,  $\varnothing 15.6$ , 16, L +/- 2 mm extended + max 3 mm for adjustment setting, 6 thick,  $\varnothing 6.1$ , 10, 16.

**Performance and Dimensions**

| TYPES     | Stroke mm | L extended mm | Compression force max. N |
|-----------|-----------|---------------|--------------------------|
| HB-15-25  | 25        | 93            | 800                      |
| HB-15-50  | 50        | 143           | 800                      |
| HB-15-75  | 75        | 193           | 800                      |
| HB-15-100 | 100       | 243           | 350                      |
| HB-15-150 | 150       | 343           | 300                      |

<sup>1</sup> Max. extension force for all stroke lengths 800 N.

**Ordering Example**

**HB-15-150-CC-M**

Type (Hydraulic Damper) \_\_\_\_\_  
 Body  $\varnothing$  (15.6 mm) \_\_\_\_\_  
 Stroke (150 mm) \_\_\_\_\_  
 Piston Rod End Fitting C5 \_\_\_\_\_  
 Body End Fitting C5 \_\_\_\_\_  
 Damping Direction (M = out stroke only) \_\_\_\_\_

**Model Type Prefix**

P: Damping in both directions  
 N: Damping on in stroke only  
 M: Damping on out stroke only  
 X: Special model suffix

**Mounting accessories see from page 200.**

Technical Data

**Compression and extension force:** 20 N to 800 N

**Free travel:** Construction of the damper results in a free travel of approx. 20 % of stroke.

**Separator piston:** Extension force 40 N; dimension L = 2.45 x stroke + 49 mm. Part number: add suffix -T.

**Operating temperature range:** -20 °C to +80 °C

**Adjustment:** Achieved by turning the piston rod in its fully extended or fully compressed position.

Clockwise rotation = increase of the damping

Anti-clockwise rotation = decrease of the damping

Damping force adjustable before installation. Adjustment can add a max. of 6 mm to the L dimension.

**Positive stop:** External positive stops 1 mm to 1.5 mm before the end of stroke provided by the customer.

**Material:** Outer body: coated steel; Piston rod: steel with wear-resistant coating; End fittings: zinc plated steel

**Mounting:** in any position

**Note:** Increased break-away force if unit has not moved for some time.

**End fittings:** They are interchangeable and if necessary must be positively secured by the customer to prevent unscrewing.

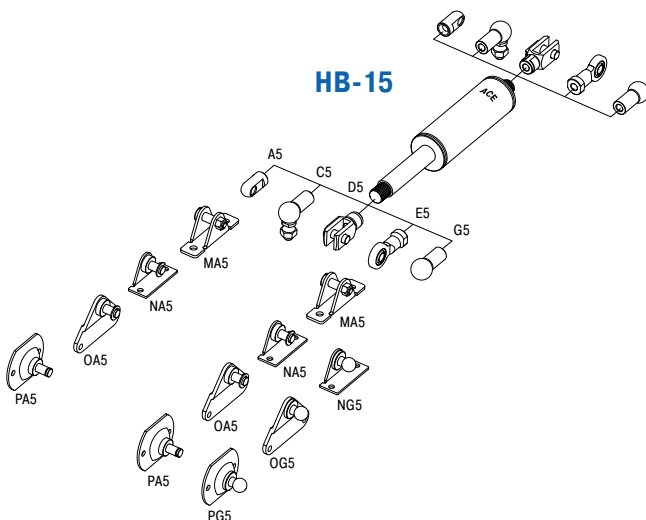

Adjustable, Compression and extension force 30 N to 1,800 N

**End Fitting**
**Standard Dimensions**
**End Fitting**

**Performance and Dimensions**

| TYPES     | Stroke<br>mm | L extended<br>mm | <sup>1</sup> Compression force max.<br>N |
|-----------|--------------|------------------|--|
| HB-22-50  | 50           | 150              | 1,800                                    |
| HB-22-100 | 100          | 250              | 1,800                                    |
| HB-22-150 | 150          | 350              | 1,800                                    |
| HB-22-200 | 200          | 450              | 1,000                                    |
| HB-22-250 | 250          | 550              | 1,000                                    |

<sup>1</sup> Max. extension force for all stroke lengths 1,800 N.

**Ordering Example**

**HB-22-150-DD-M**

Type (Hydraulic Damper) \_\_\_\_\_  
 Body Ø (23 mm) \_\_\_\_\_  
 Stroke (150 mm) \_\_\_\_\_  
 Piston Rod End Fitting D8 \_\_\_\_\_  
 Body End Fitting D8 \_\_\_\_\_  
 Damping Direction (M = out stroke only) \_\_\_\_\_

**Model Type Prefix**

P: Damping in both directions  
 N: Damping on in stroke only  
 M: Damping on out stroke only  
 X: Special model suffix

**Mounting accessories see from page 200.**

**End Fitting Options:**

- Eye A8** max. force 3,000 N
- Stud Thread B8**
- Angle Ball Joint C8** max. force 1,200 N
- Clevis Fork D8** max. force 3,000 N
- Swivel Eye E8** max. force 3,000 N
- Ball Socket G8** max. force 1,200 N

**Rod Shroud W8-22**

Ø 28  
 L = Stroke + 30

**Technical Data**
**Compression and extension force:** 30 N to 1,800 N

**Free travel:** Construction of the damper results in a free travel of approx. 20 % of stroke.

**Separator piston:** Extension force 50 N; dimension L = 2.38 x stroke + 55 mm. Part number: add suffix -T.

**Operating temperature range:** -20 °C to +80 °C

**Adjustment:** Achieved by turning the piston rod in its fully extended or fully compressed position.

Clockwise rotation = increase of the damping

Anti-clockwise rotation = decrease of the damping

Damping force adjustable before installation. Adjustment can add a max. of 6 mm to the L dimension.

**Positive stop:** External positive stops 1 mm to 1.5 mm before the end of stroke provided by the customer.

**Material:** Outer body: coated steel; Piston rod: steel with wear-resistant coating; End fittings: zinc plated steel

**Mounting:** in any position

**Note:** Increased break-away force if unit has not moved for some time.

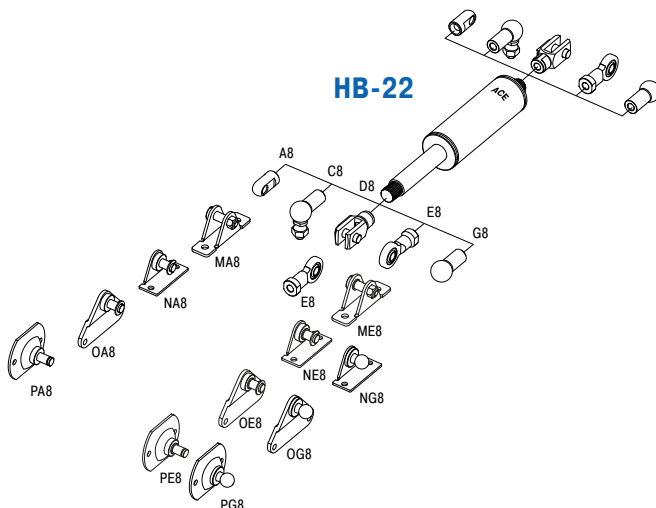
**End fittings:** They are interchangeable and if necessary must be positively secured by the customer to prevent unscrewing.

Adjustable, Compression and extension force 30 N to 3,000 N

End Fitting

Standard Dimensions

End Fitting

**Performance and Dimensions**

| TYPES     | Stroke mm | L extended mm | <sup>1</sup> Compression force max. N |
|-----------|-----------|---------------|---------------------------------------|
| HB-28-100 | 100       | 260           | 3,000                                 |
| HB-28-150 | 150       | 360           | 3,000                                 |
| HB-28-200 | 200       | 460           | 3,000                                 |
| HB-28-250 | 250       | 560           | 3,000                                 |
| HB-28-300 | 300       | 660           | 2,500                                 |
| HB-28-350 | 350       | 760           | 2,000                                 |
| HB-28-400 | 400       | 860           | 1,500                                 |
| HB-28-500 | 500       | 1,060         | 1,000                                 |

<sup>1</sup> Max. extension force for all stroke lengths 3,000 N.

**Ordering Example**

HB-28-150-DD-M

Type (Hydraulic Damper) \_\_\_\_\_  
 Body Ø (28 mm) \_\_\_\_\_  
 Stroke (150 mm) \_\_\_\_\_  
 Piston Rod End Fitting D8 \_\_\_\_\_  
 Body End Fitting D8 \_\_\_\_\_  
 Damping Direction (M = out stroke only) \_\_\_\_\_

**Model Type Prefix**

P: Damping in both directions  
 N: Damping on in stroke only  
 M: Damping on out stroke only  
 X: Special model suffix

**Mounting accessories see from page 200.**

**End Fitting Options:**

- Eye A8 max. force 3,000 N
- Stud Thread B8
- Angle Ball Joint C8 max. force 1,200 N
- Clevis Fork D8 max. force 3,000 N
- Swivel Eye E8 max. force 3,000 N
- Ball Socket G8 max. force 1,200 N

**Rod Shroud W8-28**

Ø 32  
 L = Stroke + 40

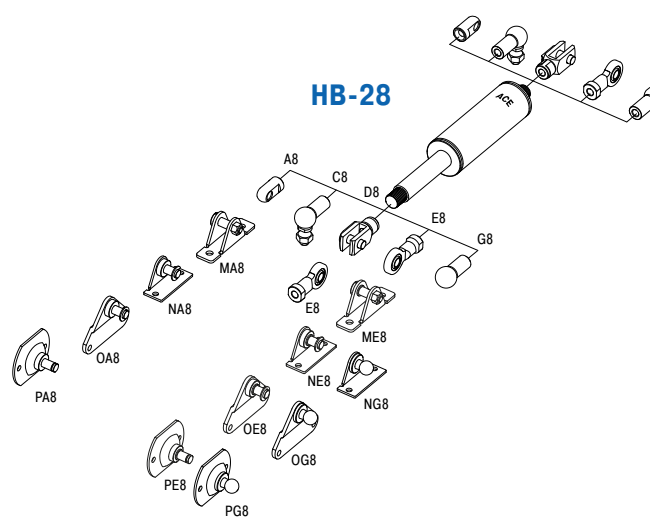

Technical Data

**Compression and extension force:** 30 N to 3,000 N

**Free travel:** Construction of the damper results in a free travel of approx. 20 % of stroke.

**Separator piston:** Extension force 80 N; dimension L = 2.35 x stroke + 60 mm. Part number: add suffix -T.

**Operating temperature range:** -20 °C to +80 °C

**Adjustment:** Achieved by turning the piston rod in its fully extended or fully compressed position.

Clockwise rotation = increase of the damping

Anti-clockwise rotation = decrease of the damping

Damping force adjustable before installation. Adjustment can add a max. of 6 mm to the L dimension.

**Positive stop:** External positive stops 1 mm to 1.5 mm before the end of stroke provided by the customer.

**Material:** Outer body: coated steel; Piston rod: steel with wear-resistant coating; End fittings: zinc plated steel

**Mounting:** in any position

**Note:** Increased break-away force if unit has not moved for some time.

**End fittings:** They are interchangeable and if necessary must be positively secured by the customer to prevent unscrewing.



Adjustable, Compression and extension force 30 N to 10,000 N

**End Fitting**
**Standard Dimensions**
**End Fitting**
**A14**

**Eye A14**  
max. force 10,000 N

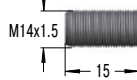
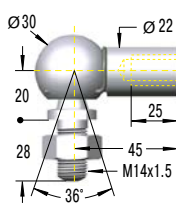
**B14**

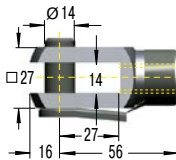
**Stud Thread B14**
**C14**

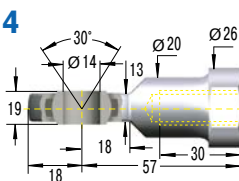
**Angle Ball Joint C14**  
max. force 3,200 N

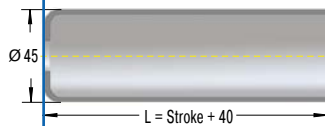
**D14**

**Clevis Fork D14**  
max. force 10,000 N

**E14**

**Swivel Eye E14**  
max. force 10,000 N

**Rod Shroud W14-40**

**Performance and Dimensions**

| TYPES     | Stroke<br>mm | L extended<br>mm | <sup>1</sup> Compression force max.<br>N |
|-----------|--------------|------------------|--|
| HB-40-100 | 100          | 275              | 10,000                                   |
| HB-40-150 | 150          | 375              | 10,000                                   |
| HB-40-200 | 200          | 475              | 10,000                                   |
| HB-40-300 | 300          | 675              | 10,000                                   |
| HB-40-400 | 400          | 875              | 8,000                                    |
| HB-40-500 | 500          | 1,075            | 6,000                                    |
| HB-40-600 | 600          | 1,275            | 4,000                                    |
| HB-40-700 | 700          | 1,475            | 3,000                                    |
| HB-40-800 | 800          | 1,675            | 3,000                                    |

<sup>1</sup> Max. extension force for all stroke lengths 10,000 N.

**Ordering Example**

Type (Hydraulic Damper) → **HB-40-300-EE-N**  
 Body Ø (40 mm) →  
 Stroke (300 mm) →  
 Piston Rod End Fitting E14 →  
 Body End Fitting E14 →  
 Damping Direction (N = in stroke only) →

**Model Type Prefix**

P: Damping in both directions  
 N: Damping on in stroke only  
 M: Damping on out stroke only  
 X: Special model suffix

**Mounting accessories see from page 200.**

**Technical Data**

**Compression and extension force:** 30 N to 10,000 N

**Free travel:** Construction of the damper results in a free travel of approx. 20 % of stroke.

**Separator piston:** Extension force 150 N; dimension L = 2.32 x stroke + 82 mm. Part number: add suffix -T.

**Operating temperature range:** -20 °C to +80 °C

**Adjustment:** Achieved by turning the piston rod in its fully extended or fully compressed position.

Clockwise rotation = increase of the damping

Anti-clockwise rotation = decrease of the damping

Damping force adjustable before installation. Adjustment can add a max. of 6 mm to the L dimension.

**Positive stop:** External positive stops 1 mm to 1.5 mm before the end of stroke provided by the customer.

**Material:** Outer body: coated steel; Piston rod: steel with wear-resistant coating; End fittings: zinc plated steel

**Mounting:** in any position

**Note:** Increased break-away force if unit has not moved for some time.

**End fittings:** They are interchangeable and if necessary must be positively secured by the customer to prevent unscrewing.

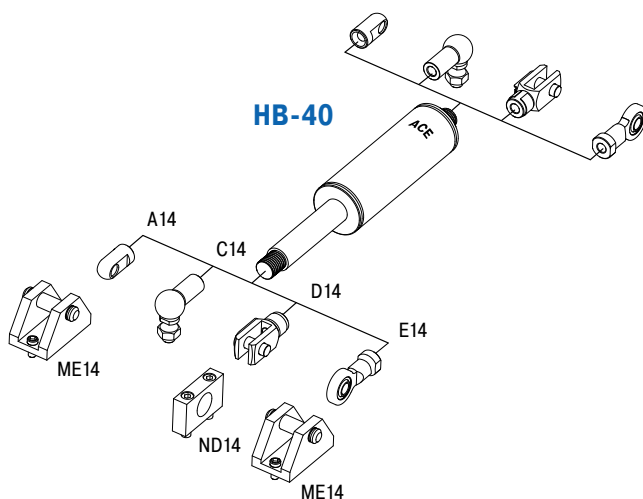



Adjustable, Compression and extension force 2,000 N to 50,000 N

End Fitting

Standard Dimensions

End Fitting

**B24** Stud Thread **B24**

**D24** Clevis Fork **D24**  
max. force 50,000 N

**E24** Swivel Eye **E24**  
max. force 50,000 N

**Performance and Dimensions**

| TYPES     | Stroke<br>mm | L extended<br>mm | <sup>1</sup> Compression force max.<br>N |
|-----------|--------------|------------------|--|
| HB-70-100 | 111          | 331              | 50,000                                   |
| HB-70-200 | 211          | 531              | 50,000                                   |
| HB-70-300 | 311          | 731              | 50,000                                   |
| HB-70-400 | 411          | 931              | 30,300                                   |
| HB-70-500 | 511          | 1,131            | 21,600                                   |
| HB-70-600 | 611          | 1,331            | 16,200                                   |
| HB-70-700 | 711          | 1,531            | 12,600                                   |
| HB-70-800 | 811          | 1,731            | 10,100                                   |

<sup>1</sup> Max. extension force for all stroke lengths 50,000 N.

**Ordering Example**

**HB-70-300-EE-N**

Type (Hydraulic Damper) \_\_\_\_\_  
 Body Ø (70 mm) \_\_\_\_\_  
 Stroke (300 mm) \_\_\_\_\_  
 Piston Rod End Fitting E24 \_\_\_\_\_  
 Body End Fitting E24 \_\_\_\_\_  
 Damping Direction (N = in stroke only) \_\_\_\_\_

**Model Type Prefix**

P: Damping in both directions  
 N: Damping on in stroke only  
 M: Damping on out stroke only  
 X: Special model suffix

**Mounting accessories see from page 200.**

**Rod Shroud W24-70**

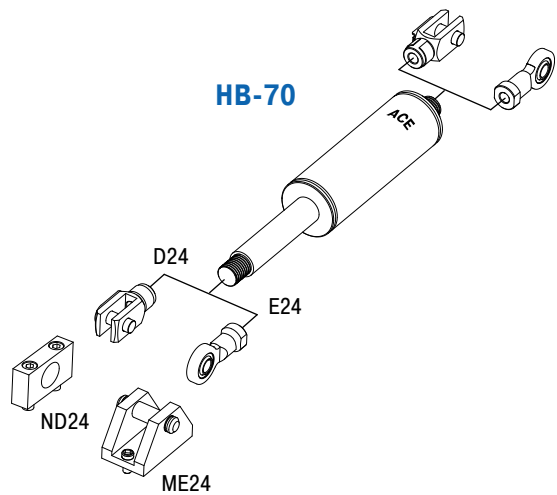

Technical Data

- Compression and extension force:** 2,000 N to 50,000 N
- Free travel:** Construction of the damper results in a free travel of approx. 20 % of stroke.
- Separator piston:** Extension force min. 250 N; dimension L + 150 mm. Part number: add suffix -T.
- Operating temperature range:** -20 °C to +80 °C
- Adjustment:** Achieved by turning the piston rod in its fully extended or fully compressed position.  
 Clockwise rotation = increase of the damping  
 Anti-clockwise rotation = decrease of the damping  
 Damping force adjustable before installation. The adjustment can add a max. of 5 mm to the L dimension.
- Positive stop:** External positive stops 5 mm to 6 mm before the end of stroke provided by the customer.
- Material:** Outer body: coated steel; Piston rod: hard chrome plated steel; End fittings: zinc plated steel
- Mounting:** in any position
- Note:** Increased break-away force if unit has not moved for some time.
- End fittings:** They are interchangeable and if necessary must be positively secured by the customer to prevent unscrewing.

# Locate and Eliminate Disturbing Vibration

## Vibration isolation

- Free App for iPhone
- Precise 3-axis measurement system
- Simple & comprehensible menu
- Immediate product recommendation
- Available in English, German and French

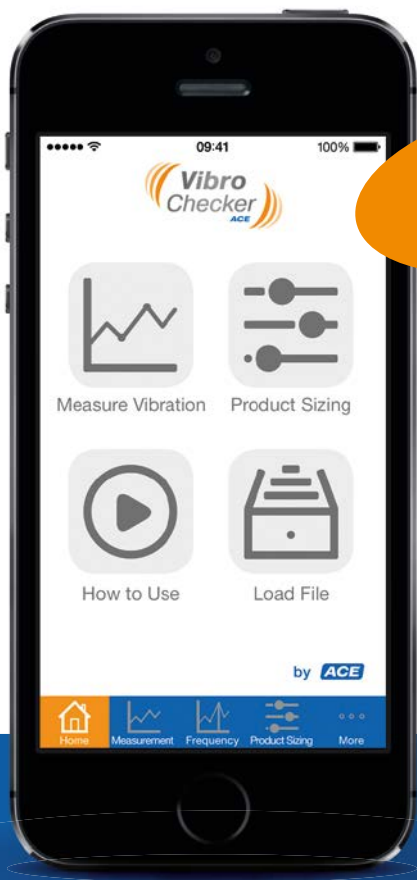

free in the  
App Store

Start now.  
**Free App!**



[www.vibrochecker.com](http://www.vibrochecker.com)

## TD, TDE

### The safe way to close doors

#### Adjustable

**Energy capacity 75 Nm/Cycle to 190 Nm/Cycle**

**Stroke 50 mm to 120 mm**

Safety for individuals, doors and frames: whether acting single-sided or double-sided, ACE TD-28 and TDE-28 dampers securely prevent doors of all types and many weight classes from slamming shut. This is because the energy for stroke lengths between 50 mm and 120 mm is absorbed so reliably, that people and their possessions are protected.

The desired attenuation force is set manually; as a result, this door damper can absorb energy up to max. 190 Nm/stroke. Impact masses up to a maximum of 7,000 kg can be overcome depending on which type. ACE door dampers are manufactured to be high quality and durable with hard chrome-plated piston rod and galvanised steel cylinder tubes.

Practical and safe, these door dampers are suitable for manual or automatically operated hinged and sliding doors, as is often seen in the elevator and furniture industries, as well as in building technology.



#### Technical Data

**Outer body diameter:** Ø 28 mm

**Piston rod diameter:** Ø 8 mm

**Free travel:** TDE: marginal

**Operating temperature range:** -20 °C to +80 °C

**Adjustment:** Pull the piston rod fully out and turn the knurled rod end button. The internal toothed adjustment allows the damping to be separately adjusted for each side. As a result of the adjustment mechanism the overall length L can be increased by up to 4 mm (TDE-28) or 8 mm (TD-28).

**Material:** Outer body: zinc plated steel; Piston rod: hard chrome plated steel

**Impact velocity range:** 0.1 m/s to 2 m/s

**Strokes per minute:** max. 10

**Application field:** lift doors, automatic doors, doors

**Note:** ACE door dampers are single ended or double ended adjustable hydraulic shock absorbers.

**On request:** Special oils, other special options and special accessories are available on request.

### TD-28

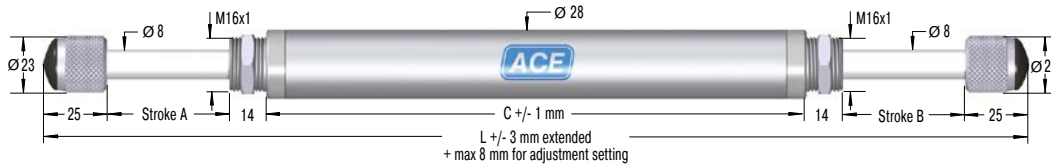

### MB-16 Clamp Mount

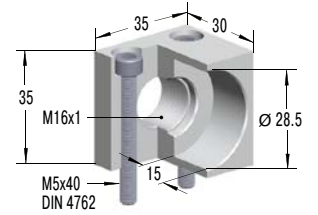

### Model Type Prefix

F: Automatic return with return spring  
 D: Without return spring. When one piston is pushed in, the piston rod at the other end is pushed out (thus the damper must be impacted from alternate ends to sequence correctly).

### Ordering Example

Type (Door Damper) \_\_\_\_\_ **TD-28-50-50**  
 Body Ø (28 mm) \_\_\_\_\_  
 Stroke A (50 mm) \_\_\_\_\_  
 Stroke B (50 mm) \_\_\_\_\_

### Performance and Dimensions

| TYPES           | Energy capacity<br>Nm/cycle | Reacting Force<br>N | Impact Mass max.<br>kg | Stroke A<br>mm | Stroke B<br>mm | C<br>mm | L extended<br>mm | Return Force max.<br>N | Return Type |
|-----------------|-----------------------------|---------------------|------------------------|----------------|----------------|---------|------------------|------------------------|-------------|
| TD-28-50-50-F   | 75                          | 1,550               | 150                    | 50             | 50             | 220     | 402              | 30                     | F           |
| TD-28-70-70-F   | 70                          | 1,500               | 200                    | 70             | 70             | 260     | 482              | 30                     | F           |
| TD-28-100-100-F | 80                          | 1,500               | 250                    | 100            | 100            | 220     | 502              | 40                     | F           |
| TD-28-120-120-D | 165                         | 3,800               | 250                    | 120            | 120            | 208     | 417              | -                      | D           |

<sup>1</sup> Standard model. Other models available on request.

### TDE-28

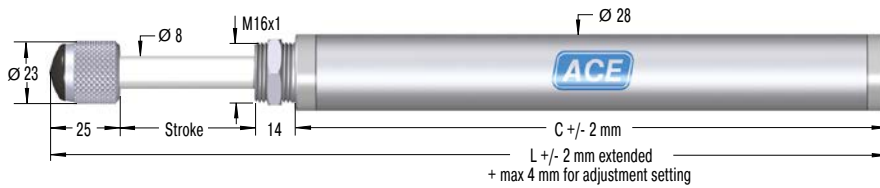

### MB-16 Clamp Mount

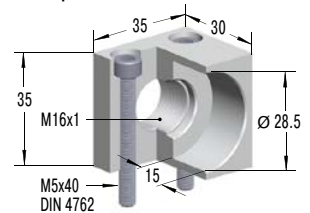

### Ordering Example

Type (Door Damper) \_\_\_\_\_ **TDE-28-50**  
 Body Ø (28 mm) \_\_\_\_\_  
 Stroke (50 mm) \_\_\_\_\_

### Performance and Dimensions

| TYPES      | Energy capacity<br>Nm/cycle | Reacting Force<br>N | Impact Mass max.<br>kg | Stroke<br>mm | C<br>mm | L extended<br>mm | Return Force max.<br>N |
|------------|-----------------------------|---------------------|------------------------|--------------|---------|------------------|------------------------|
| TDE-28-50  | 80                          | 2,400               | 4,000                  | 50           | 130     | 219              | 30                     |
| TDE-28-70  | 112                         | 2,400               | 5,600                  | 70           | 158     | 267              | 30                     |
| TDE-28-100 | 160                         | 2,400               | 8,000                  | 100          | 193     | 332              | 30                     |
| TDE-28-120 | 190                         | 2,400               | 7,000                  | 120          | 214     | 371              | 40                     |

## Application Examples

### DVC-32

#### Precise unreeling

Hydraulic dampers bring the sled movement of this textile machine to a gentle stop. At the turning point of 130 kg reeling spools, a sled should move up and down smoothly without causing a collision at the end of stroke position. The solution was provided by the hydraulic damper DVC-32-100EU. A self-contained sealed unit, ready to install and maintenance-free these units are ideal for precise control of speeds in both directions of travel. The travel speed is maintained throughout the entire stroke and can be independently adjusted in each direction of travel. Thanks to their compact design and wide choice of mounting accessories, these dampers could be easily integrated into this machine.

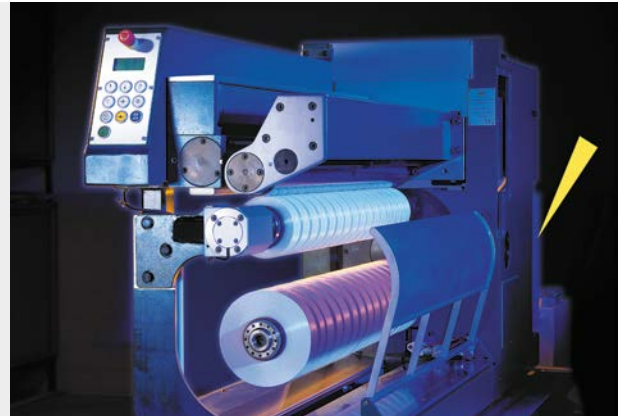

Textile machine unreels threads even better

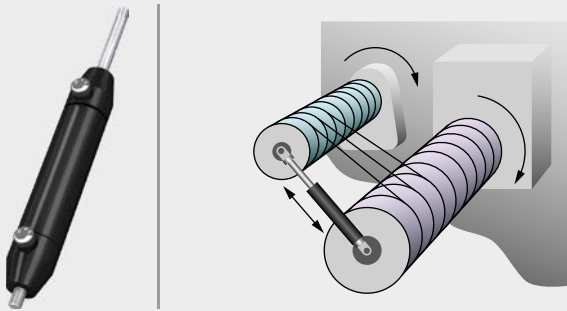

### HB-15

#### Operating speed of flaps top-regulated

In the past, operators of used-clothes containers could sustain injury because the flaps closed relatively quickly and uncontrollably. Various hydraulic dampers of the type HB-15, which are designed specifically for the type of container, regulate the synchronization of the flap in both directions and thereby serve to regulate the operating speed. To accommodate a range of requirements and to provide optimal protection against theft, different types with different strokes are mounted on flaps without damping, on large flaps with damping and on rotor flaps with damping.



Hydraulic dampers prevent fingers becoming trapped in used-clothes containers as they ensure more gentle opening and closing movements  
MCB Milieu & Techniek BV, 4704 SE Roosendaal, Netherlands

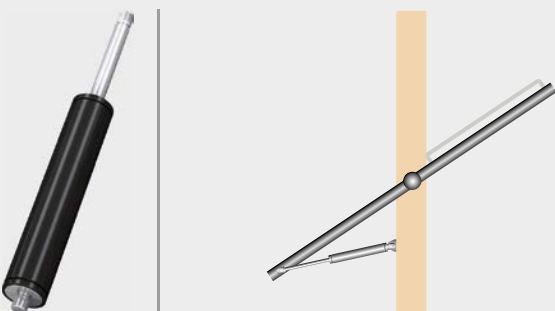

## HB-40

### Swinging movements cushioned by hydraulic dampers

Passengers always feel the swinging movement involved when cable cars arrive at the ski station. Maintenance-free hydraulic dampers type HB-40-300-EE-X-P cushion these movements perfectly. Designers of the cable cars, connected by means of an articulated joint via a four-point frame and connection guide to the suspension rod, profit from the ability of the adjustable dampers to absorb compressive forces of up to 10,000 N on either side.



Hydraulic dampers for added convenience when operating cable cars

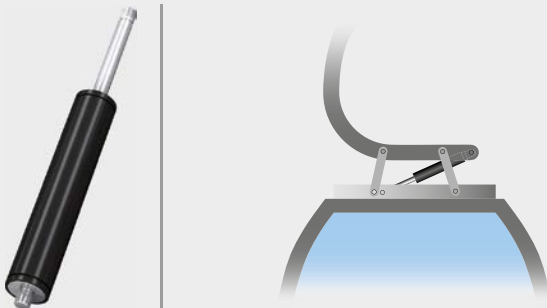



## Mounting Accessories

for gas springs and hydraulic dampers  
made of steel

By taking advantage of the very extensive range of ACE end fittings and mounting brackets you can easily and simply install our gas springs and hydraulic dampers. You profit from the variety of DIN Standard end fittings such as swivel eyes, clevis forks, angle ball joints, inline ball joints, and complementary ball sockets.

ACE also offers eye fittings made of wear-resistant steel to meet the higher specification requirements found in industrial applications. With over 30 different types available these mounting accessories provide an extensive range of combinations for optimum installations.

With the ACE selection programme you can choose not only your ACE gas springs but also the ideal end fittings and mounting brackets for your individual application example.

**The complete range of accessories are also available as individual components.**

**Individual  
Combinations!**

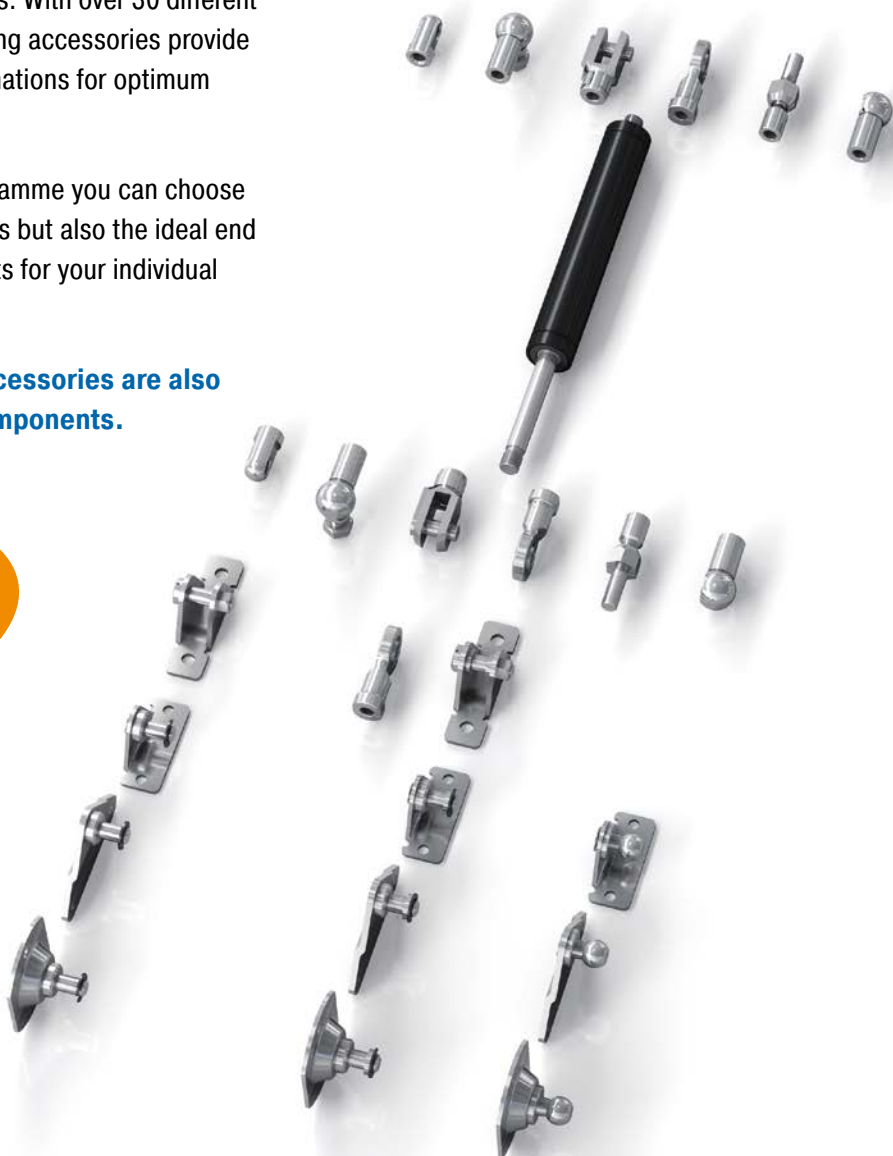

### M3.5x0.6

(for GS-8, GS-10, GS-12, GZ-15, HB-12)

#### C3,5

Angle Ball Joint  
DIN 71802

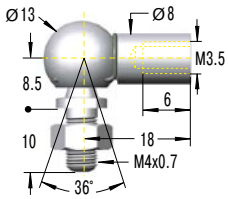

<sup>1</sup> max. force 370 N

#### E3,5

Swivel Eye  
DIN 648

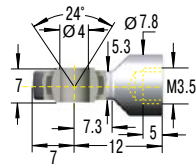

<sup>1</sup> max. force 370 N

#### A3,5

Eye

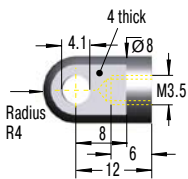

<sup>1</sup> max. force 370 N



#### NA3,5

Angle Bracket with Ball

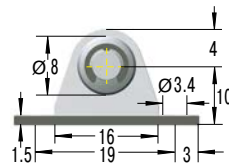

<sup>1</sup> max. force 180 N

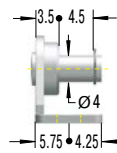

#### OA3,5

Side Bracket with Ball

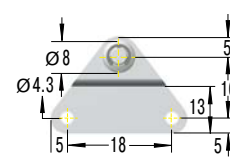

<sup>1</sup> max. force 180 N

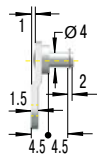

#### D3,5

Clevis Fork  
DIN 71752

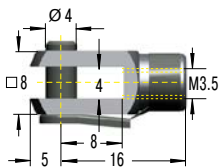

<sup>1</sup> max. force 370 N



#### A3,5

Eye

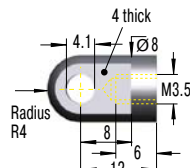

<sup>1</sup> max. force 370 N

#### G3,5

Ball Socket  
DIN 71805

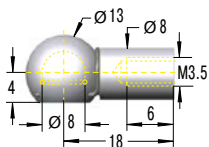

<sup>1</sup> max. force 370 N



#### NG3,5

Angle Bracket with Ball

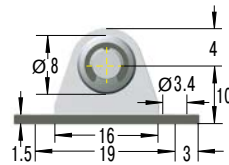

<sup>1</sup> max. force 180 N

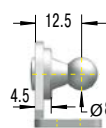

#### OG3,5

Side Bracket with Ball

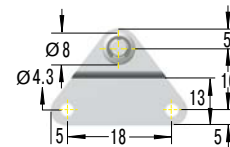

<sup>1</sup> max. force 180 N

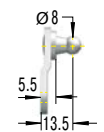

<sup>1</sup>Attention! Max. static load in Newtons. Beware force increase during compression (progression) and observe max. force limit.

**M5x0.8**

(for GS-15, HB-15)

**C5**  
Angle Ball Joint  
DIN 71802

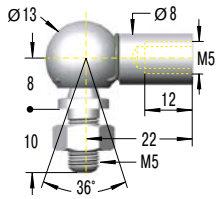

<sup>1</sup> max. force 500 N

**D5**  
Clevis Fork  
DIN 71752

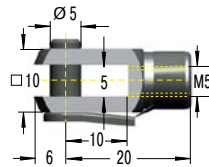

<sup>1</sup> max. force 800 N

**F5**  
Inline Ball Joint

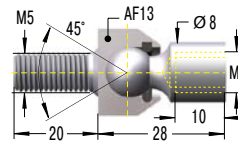

<sup>1</sup> max. force 500 N  
Attention! Must only be used with compression loads!

**A5**  
Eye

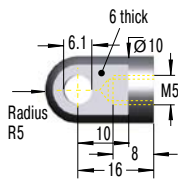

<sup>1</sup> max. force 800 N

**MA5**  
Bearing Shoe

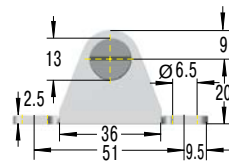

<sup>1</sup> max. force 500 N

**NA5**  
Angle Bracket with Ball

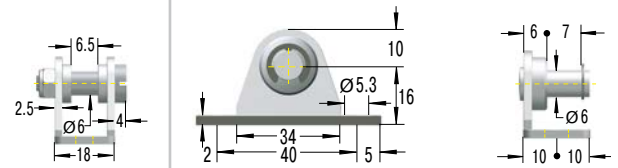

<sup>1</sup> max. force 400 N



**E5**  
Swivel Eye  
DIN 648

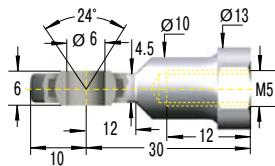

<sup>1</sup> max. force 800 N

**OA5**  
Side Bracket with Ball

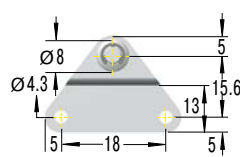

<sup>1</sup> max. force 180 N

**PA5**  
Round Bracket with Ball

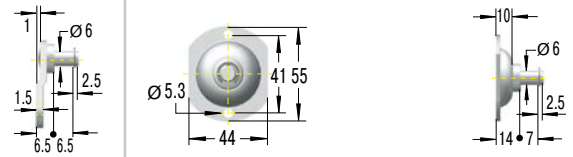

<sup>1</sup> max. force 500 N

**G5**  
Ball Socket  
DIN 71805

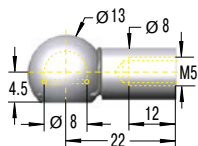

<sup>1</sup> max. force 500 N

**NG5**  
Angle Bracket with Ball

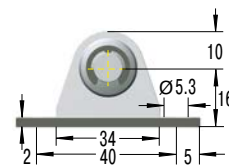

<sup>1</sup> max. force 400 N

**OG5**  
Side Bracket with Ball

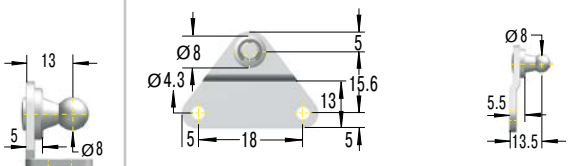

<sup>1</sup> max. force 180 N



**PG5**  
Round Bracket with Ball

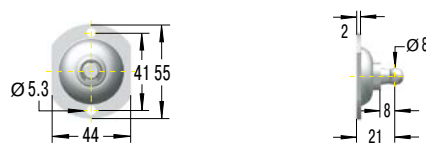

<sup>1</sup> max. force 500 N

<sup>1</sup>Attention! Max. static load in Newtons. Beware force increase during compression (progression) and observe max. force limit.

### M8x1.25

(for GS-19, GS-22, GZ-19, HB-22, HB-28, HBS-28, DVC-32)

#### C8 Angle Ball Joint DIN 71802

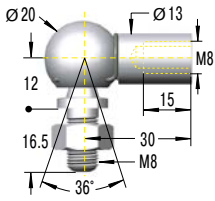

<sup>1</sup> max. force 1,200 N

#### F8 Inline Ball Joint

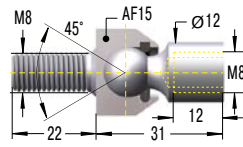

<sup>1</sup> max. force 1,200 N  
Attention! Must only be used with compression loads!

#### A8 Eye

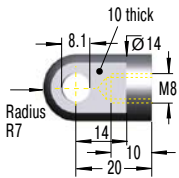

<sup>1</sup> max. force 3,000 N

#### MA8 Bearing Shoe

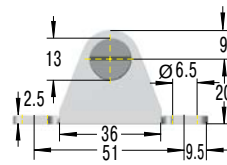

<sup>1</sup> max. force 1,800 N

#### NA8 Angle Bracket with Ball

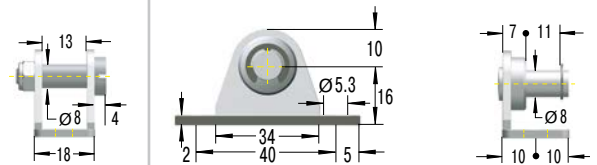

<sup>1</sup> max. force 1,000 N

#### OA8 Side Bracket with Ball

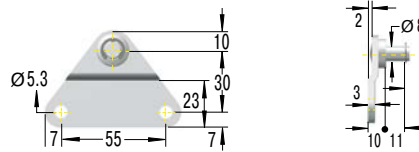

<sup>1</sup> max. force 1,200 N

#### PA8 Round Bracket with Ball

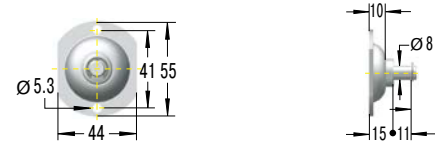

<sup>1</sup> max. force 1,200 N

#### D8 Clevis Fork DIN 71752

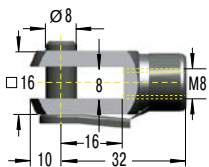

<sup>1</sup> max. force 3,000 N

#### E8 Swivel Eye DIN 648

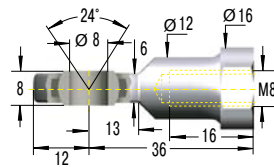

<sup>1</sup> max. force 3,000 N

<sup>1</sup> Attention! Max. static load in Newtons. Beware force increase during compression (progression) and observe max. force limit.

**M8x1.25**

(for GS-19, GS-22, GZ-19, HB-22, HB-28, HBS-28, DVC-32)

**E8**  
Swivel Eye  
DIN 648

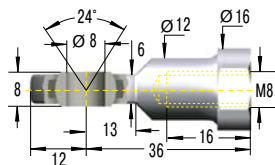

<sup>1</sup> max. force 3,000 N



**ME8**  
Bearing Shoe

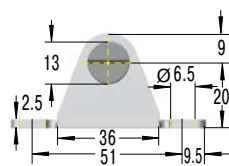

<sup>1</sup> max. force 1,800 N

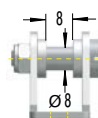

**NE8**  
Angle Bracket with Ball

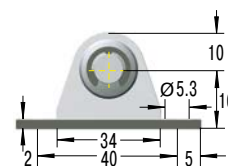

<sup>1</sup> max. force 1,000 N

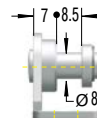

**OE8**  
Side Bracket with Ball

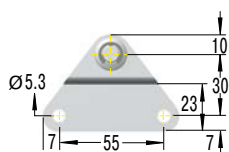

<sup>1</sup> max. force 1,200 N

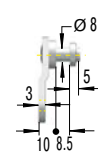

**PE8**  
Round Bracket with Ball

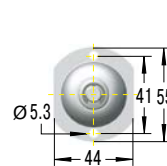

<sup>1</sup> max. force 1,200 N



**G8**  
Ball Socket  
DIN 71805

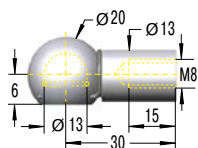

<sup>1</sup> max. force 1,200 N



**NG8**  
Angle Bracket with Ball

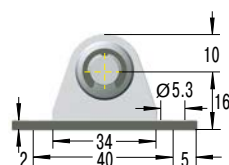

<sup>1</sup> max. force 1,000 N

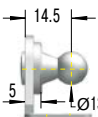

**OG8**  
Side Bracket with Ball

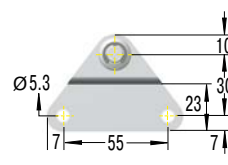

<sup>1</sup> max. force 1,200 N



**PG8**  
Round Bracket with Ball

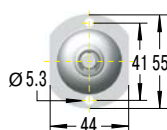

<sup>1</sup> max. force 1,200 N

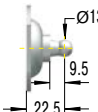

<sup>1</sup>Attention! Max. static load in Newtons. Beware force increase during compression (progression) and observe max. force limit.

### M10x1.5 (for GS-28, GZ-28, HBD-50, HBS-35)

**C10**  
Angle Ball Joint  
DIN 71802

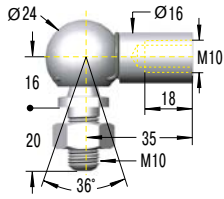

<sup>1</sup> max. force 1,800 N

**F10**  
Inline Ball Joint

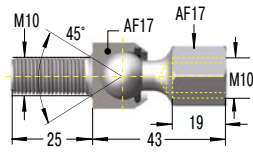

<sup>1</sup> max. force 1,800 N  
Attention! Must only be used with compression loads!

**A10**  
Eye

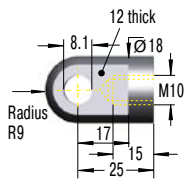

<sup>1</sup> max. force 10,000 N

**MA10**  
Bearing Shoe

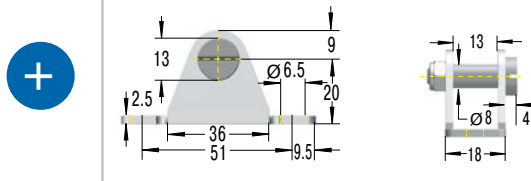

<sup>1</sup> max. force 1,800 N

**D10**  
Clevis Fork  
DIN 71752

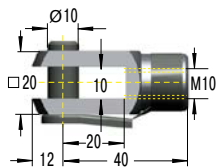

<sup>1</sup> max. force 10,000 N

**E10**  
Swivel Eye  
DIN 648

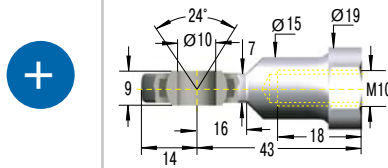

<sup>1</sup> max. force 10,000 N

**E10**  
Swivel Eye  
DIN 648

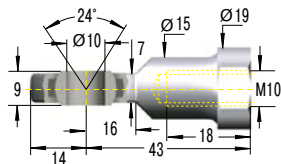

<sup>1</sup> max. force 10,000 N

**ME10**  
Bearing Shoe

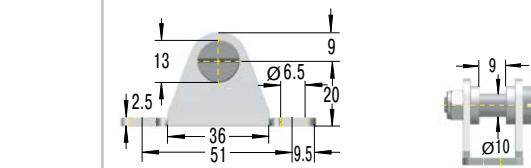

<sup>1</sup> max. force 1,800 N

**OE10**  
Side Bracket with Ball

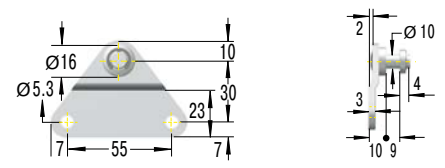

<sup>1</sup> max. force 1,200 N

**PE10**  
Round Bracket with Ball

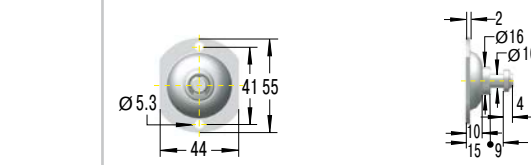

<sup>1</sup> max. force 1,200 N

Issue 07.2017 – Specifications subject to change

<sup>1</sup> Attention! Max. static load in Newtons. Beware force increase during compression (progression) and observe max. force limit.



**M14x1.5** (for GS-40, GST-40, GZ-40, HB-40, HBD-70)

**C14**  
Angle Ball Joint  
DIN 71802

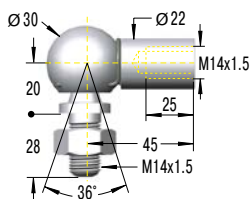

<sup>1</sup> max. force 3,200 N

**F14**  
Inline Ball Joint

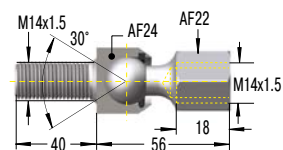

<sup>1</sup> max. force 3,200 N  
Attention! Must only be used with compression loads!

**A14**  
Eye

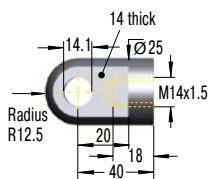

<sup>1</sup> max. force 10,000 N

**ME14**  
Bearing Shoe

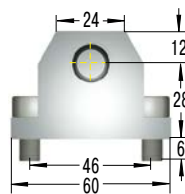

<sup>1</sup> max. force 10,000 N

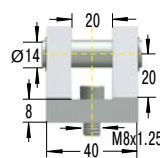

**D14**  
Clevis Fork  
DIN 71752

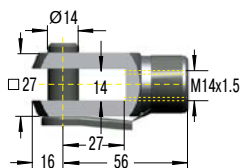

<sup>1</sup> max. force 10,000 N

**ND14**  
Mounting Flange

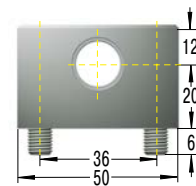

<sup>1</sup> max. force 10,000 N

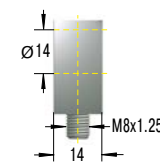

**E14**  
Swivel Eye  
DIN 648

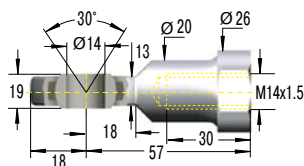

<sup>1</sup> max. force 10,000 N

**ME14**  
Bearing Shoe

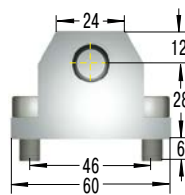

<sup>1</sup> max. force 10,000 N

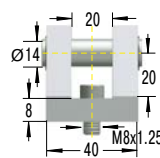

<sup>1</sup> Attention! Max. static load in Newtons. Beware force increase during compression (progression) and observe max. force limit.

### M24x2

(for GS-70, HB-70, HBD-85, HBS-70)

#### D24 Clevis Fork DIN 71752

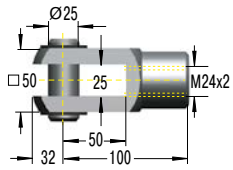

<sup>1</sup> max. force 50,000 N



#### ND24 Mounting Flange

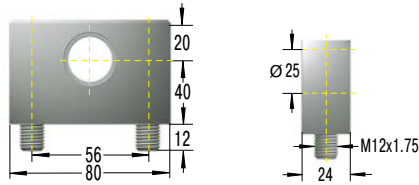

<sup>1</sup> max. force 50,000 N

#### E24 Swivel Eye DIN 648

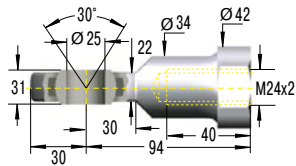

<sup>1</sup> max. force 50,000 N



#### ME24 Bearing Shoe

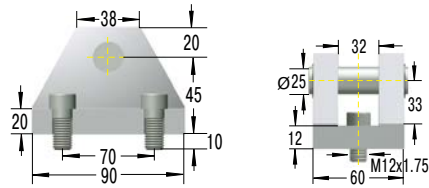

<sup>1</sup> max. force 50,000 N

<sup>1</sup>Attention! Max. static load in Newtons. Beware force increase during compression (progression) and observe max. force limit.

## Mounting Accessories

### for gas springs and hydraulic dampers made of stainless steel

For our gas springs and hydraulic dampers made of stainless steel we also offer a flexible product range of DIN standardised end fittings and mounting brackets. These eyes, swivel eyes, clevis forks, angle ball joints, ball sockets, inline ball joints and mounting brackets are also made of sturdy stainless steel and can be flexibly combined.

The high-quality stainless steel accessories are rustproof and weakly magnetic. Just as with the corresponding stainless steel gas springs and hydraulic dampers, they are preferred in the food, electronics and ship building industries along with medical and cleanroom technology.

All ACE stainless steel gas springs and the appropriate mounting accessories are individually designed for each application with the ACE calculation program.

**The entire range of stainless steel accessories is also available separately.**

**Individual  
Combinations!**

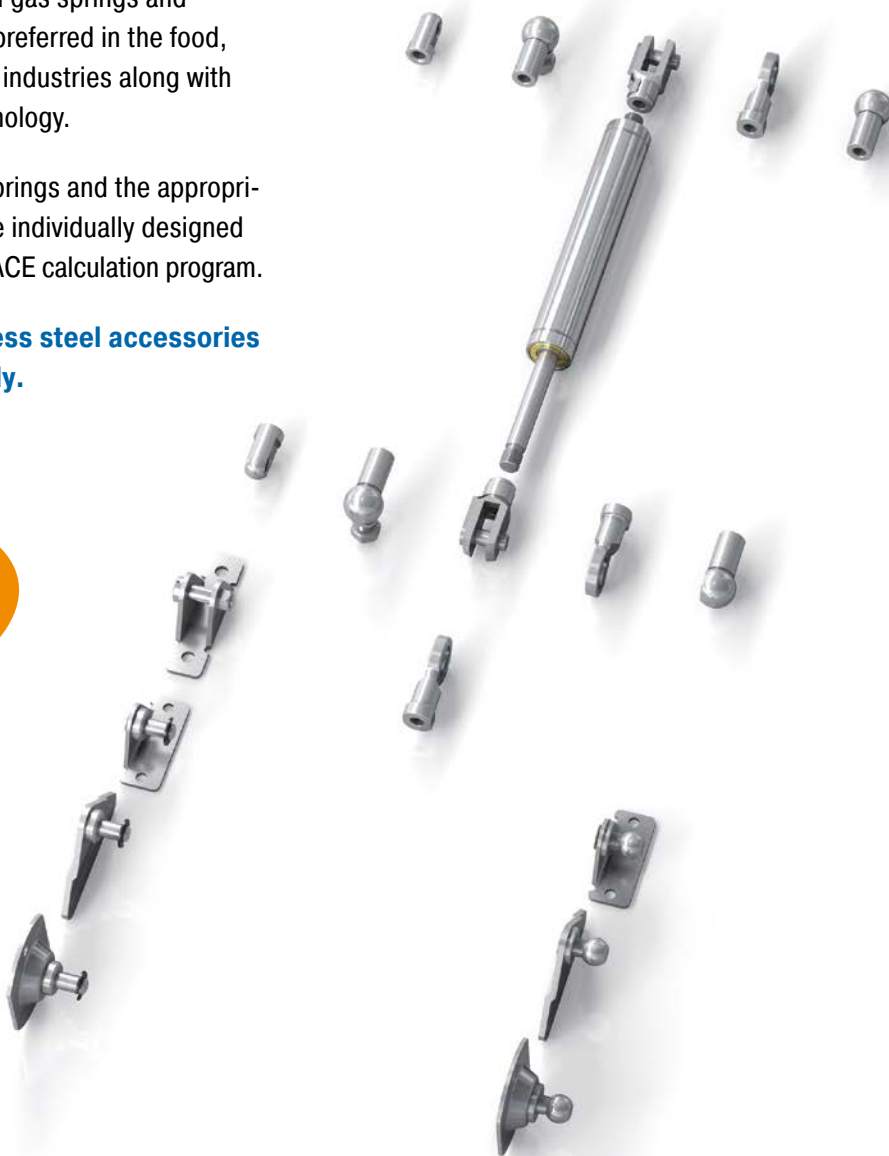

### M3.5x0.6

(for GS-8-V4A, GS-10-V4A, GS-12-V4A, GZ-15-V4A)

#### C3,5-V4A

Angle Ball Joint

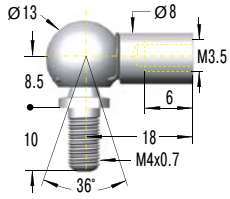

<sup>1</sup> max. force 370 N

#### A3,5-V4A

Eye

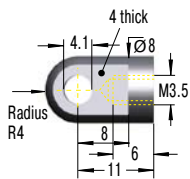

<sup>1</sup> max. force 370 N

#### NA3,5-V4A

Angle Bracket with Ball

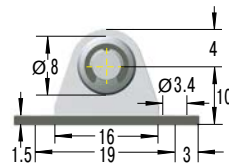

<sup>1</sup> max. force 180 N

#### OA3,5-V4A

Side Bracket with Ball

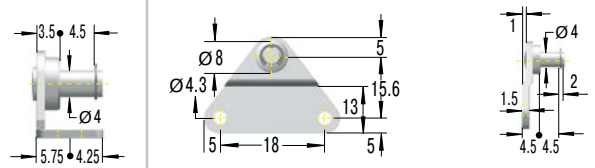

<sup>1</sup> max. force 180 N

#### D3,5-V4A

Clevis Fork

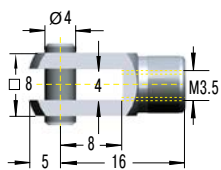

<sup>1</sup> max. force 370 N

#### A3,5-V4A

Eye

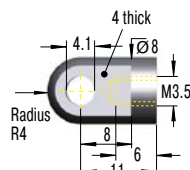

<sup>1</sup> max. force 370 N

#### G3,5-V4A

Ball Socket

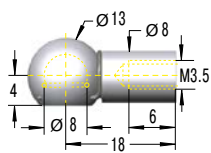

<sup>1</sup> max. force 370 N

#### NG3,5-V4A

Angle Bracket with Ball

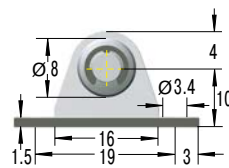

<sup>1</sup> max. force 180 N

#### OG3,5-V4A

Side Bracket with Ball

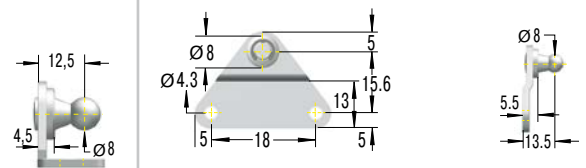

<sup>1</sup> max. force 180 N

<sup>1</sup>Attention! Max. static load in Newtons. Beware force increase during compression (progression) and observe max. force limit.

**M5x0.8 (for GS-15-VA)**

**C5-VA**  
Angle Ball Joint

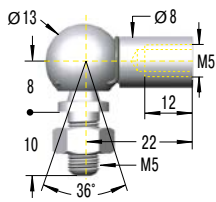

<sup>1</sup> max. force 430 N

**D5-VA**  
Clevis Fork

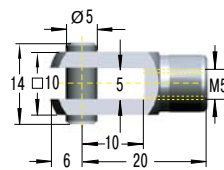

<sup>1</sup> max. force 490 N

**E5-VA**  
Swivel Eye

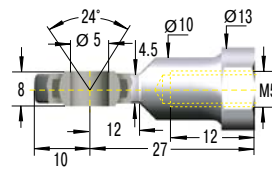

<sup>1</sup> max. force 490 N

**A5-VA**  
Eye

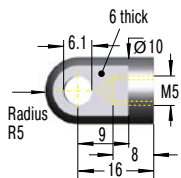

<sup>1</sup> max. force 490 N

**MA5-V4A**  
Bearing Shoe

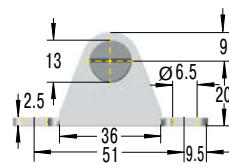

<sup>1</sup> max. force 500 N

**NA5-V4A**  
Angle Bracket with Ball

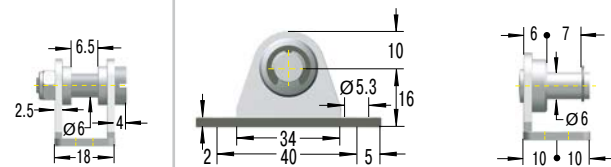

<sup>1</sup> max. force 400 N



**OA5-V4A**  
Side Bracket with Ball

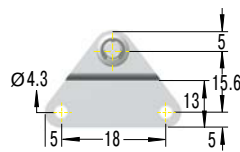

<sup>1</sup> max. force 180 N

**PA5-V4A**  
Round Bracket with Ball

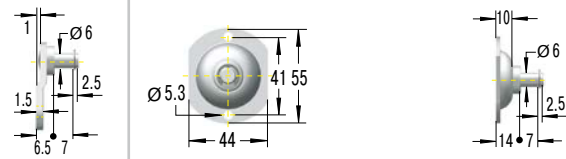

<sup>1</sup> max. force 500 N

**G5-VA**  
Ball Socket

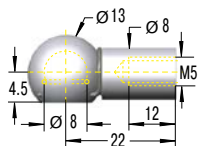

<sup>1</sup> max. force 430 N

**NG5-V4A**  
Angle Bracket with Ball

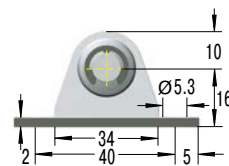

<sup>1</sup> max. force 400 N

**OG5-V4A**  
Side Bracket with Ball

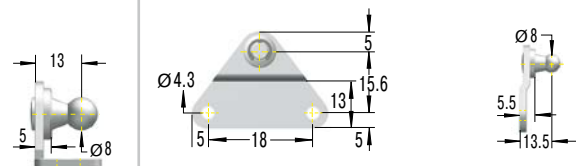

<sup>1</sup> max. force 180 N



**PG5-V4A**  
Round Bracket with Ball

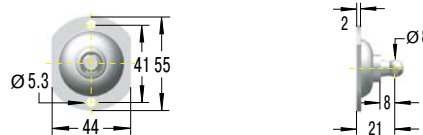

<sup>1</sup> max. force 500 N

<sup>1</sup>Attention! Max. static load in Newtons. Beware force increase during compression (progression) and observe max. force limit.

### M8x1.25

(for GS-19-VA, GS-22-VA, GZ-19-VA)

#### C8-VA Angle Ball Joint

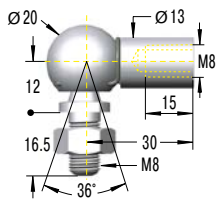

<sup>1</sup> max. force 1,140 N

#### D8-VA Clevis Fork

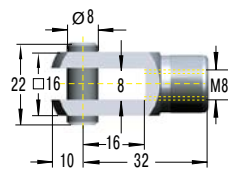

<sup>1</sup> max. force 1,560 N

#### A8-VA Eye

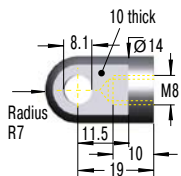

<sup>1</sup> max. force 1,560 N

#### MA8-V4A Bearing Shoe

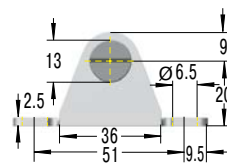

<sup>1</sup> max. force 1,800 N

#### NA8-V4A Angle Bracket with Ball

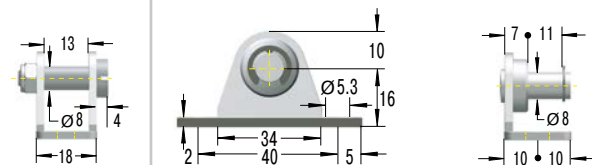

<sup>1</sup> max. force 1.000 N

#### OA8-V4A Side Bracket with Ball

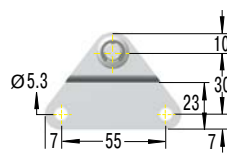

<sup>1</sup> max. force 1,200 N

#### PA8-V4A Round Bracket with Ball

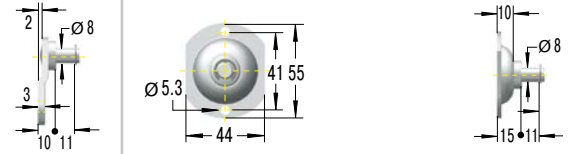

<sup>1</sup> max. force 1,200 N

#### E8-VA Swivel Eye

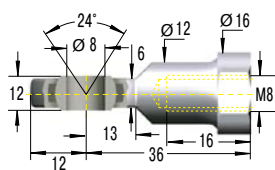

<sup>1</sup> max. force 1,560 N

#### MA8-V4A Bearing Shoe

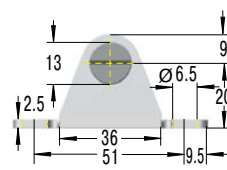

<sup>1</sup> max. force 1,800 N

<sup>1</sup>Attention! Max. static load in Newtons. Beware force increase during compression (progression) and observe max. force limit.



**M8x1.25 (for GS-19-VA, GS-22-VA, GZ-19-VA)**

**G8-VA**  
Ball Socket

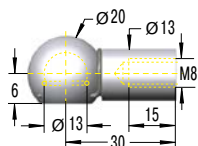

<sup>1</sup> max. force 1,140 N

**NG8-V4A**  
Angle Bracket with Ball

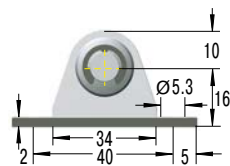

<sup>1</sup> max. force 1,000 N

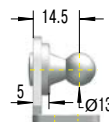

**OG8-V4A**  
Side Bracket with Ball

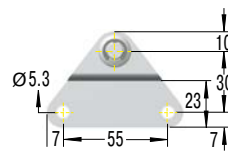

<sup>1</sup> max. force 1,200 N

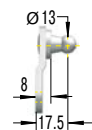

**PG8-V4A**  
Round Bracket with Ball



<sup>1</sup> max. force 1,200 N

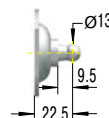

**M10x1.5 (for GS-28-VA, GZ-28-VA)**

**C10-VA**  
Angle Ball Joint

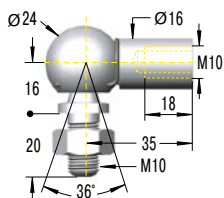

<sup>1</sup> max. force 1,750 N

**D10-VA**  
Clevis Fork

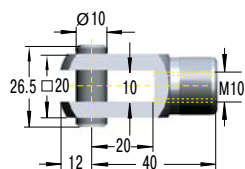

<sup>1</sup> max. force 3,800 N

**E10-VA**  
Swivel Eye

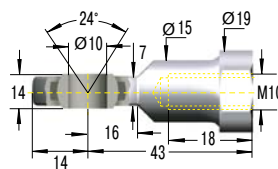

<sup>1</sup> max. force 3,800 N

**A10-VA**  
Eye

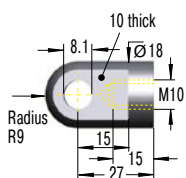

<sup>1</sup> max. force 3,800 N



**MA10-V4A**  
Bearing Shoe

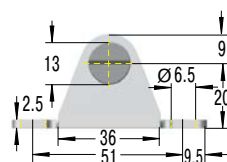

<sup>1</sup> max. force 1,800 N

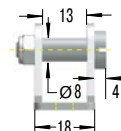

<sup>1</sup>Attention! Max. static load in Newtons. Beware force increase during compression (progression) and observe max. force limit.

### M14x1.5 (for GS-40-VA, GZ-40-VA)

#### C14-VA Angle Ball Joint

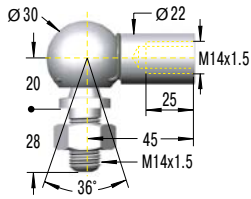

<sup>1</sup> max. force 3,200 N

#### A14-VA Eye

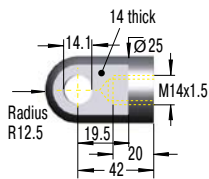

<sup>1</sup> max. force 7,000 N

#### ME14-VA Bearing Shoe

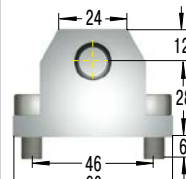

<sup>1</sup> max. force 10,000 N

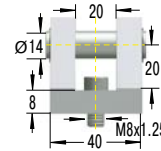

#### D14-VA Clevis Fork

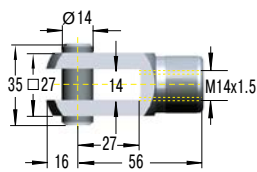

<sup>1</sup> max. force 7,000 N

#### ND14-VA Mounting Flange

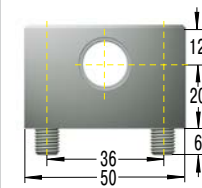

<sup>1</sup> max. force 10,000 N

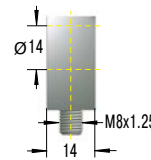

#### E14-VA Swivel Eye

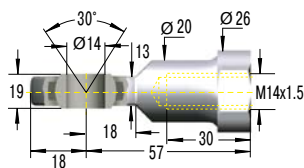

<sup>1</sup> max. force 7,000 N

#### ME14-VA Bearing Shoe

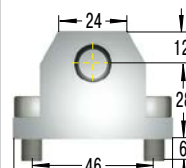

<sup>1</sup> max. force 10,000 N

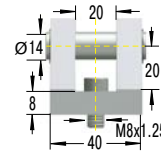

<sup>1</sup> Attention! Max. static load in Newtons. Beware force increase during compression (progression) and observe max. force limit.

# Hydraulic Feed Controls

## Regulate feed rates in the best way

**Hydraulic feed controls from ACE are recommended as the perfect solution e.g. when sawing, cutting, drilling and in order to prevent the stick-slip effect on pneumatic cylinders, amongst others. They can be precisely adjusted and provide speeds from 12 mm/min. with a very low feed force or up to 38 m/min. with a high feed rate.**

The maintenance-free, ready-to-install hydraulic feed controls are self-contained, hydraulic elements regulated by a precision throttle. The feed rate is set from the outside by turning the setting adjuster. The tried-and-testing rolling diaphragms used in many ACE shock absorbers also serve as a dynamic sealing element for a hermetic seal as well as volume compensation for the piston rod and resetting element.



## Hydraulic Feed Controls



### VC25

Adjustable

**For precision adjustment of feed rates**

Handling modules, Linear slides, Automatic machinery,  
Conveyor equipment

Page 216



### MA, MVC

Adjustable

**Designed for applications with low precision requirements**

Handling modules, Linear slides, Automatic machinery,  
Conveyor equipment

Page 218

Shorter processing times

Different feed rates

Adjustment segment at the lower end of the feed control

Most accurate calibrations

Available immediately

Easy to mount



## VC25

For precision adjustment of feed rates

### Adjustable

**Compression force 30 N to 3,500 N**

**Stroke 15 mm to 125 mm**

Precise adjustment for any type of application: Hydraulic feed controls of the product family VC are ideally suited for the precise tuning of constant feed rates. The thread of the outer body of this closed hydraulic element allows simple assembly. Designs with a smooth body can also be supplied.

As the hydraulic oil is forced out through the throttle opening, a constant feed rate is achieved on the stroke. In the models up to 55 mm stroke, the tried and tested rolling diaphragm, known from ACE shock absorbers, serves as a dynamic seal, as volume compensation of the piston rod and as a reset element.

Precision hydraulic feed controls of the product family VC are used in automotive and industrial applications as well as in automation and machine building and electronics industries.

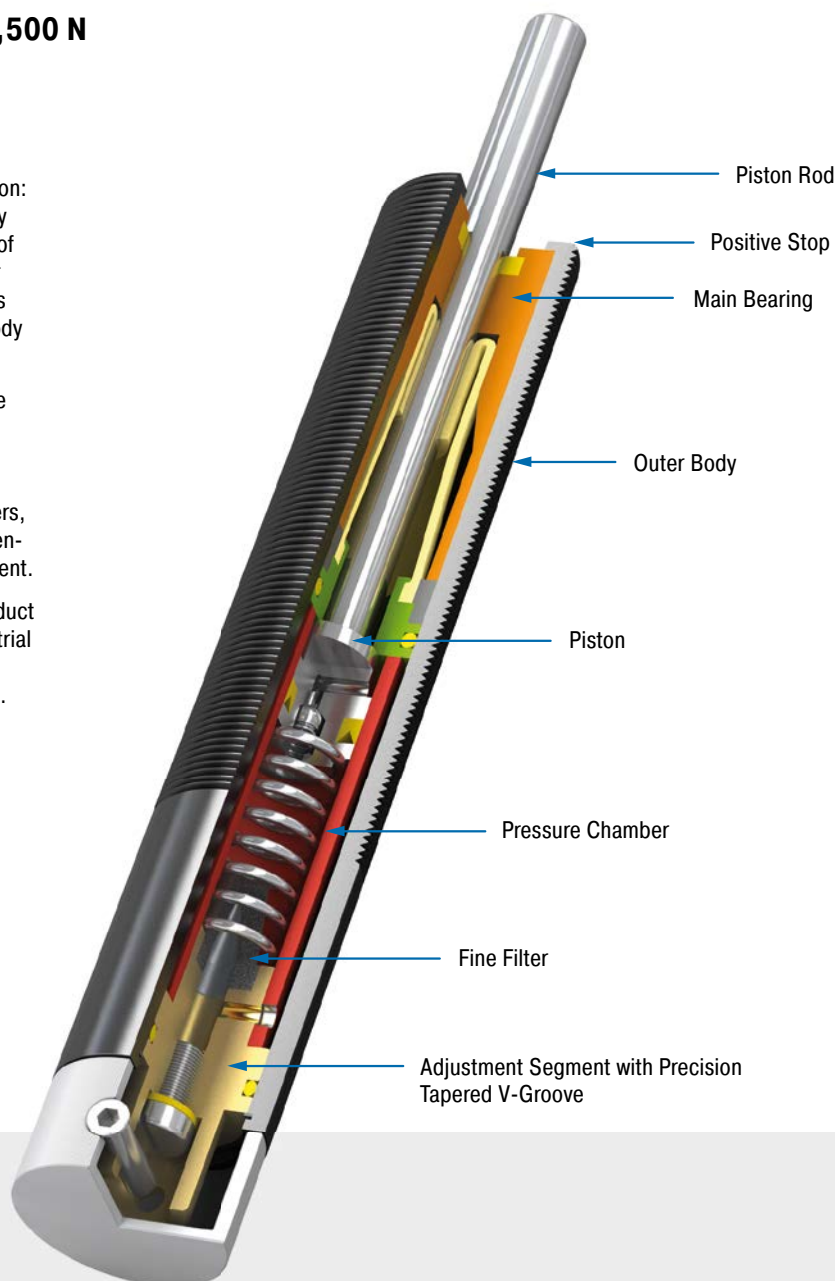

### Technical Data

**Compression force:** 30 N to 3,500 N

**Execution:** F =  $\varnothing$  23.8 mm without thread  
FT = M25x1.5 threaded body

**Piston rod diameter:**  $\varnothing$  8 mm

**Feed rate/Compression force:**  
Min. 0.013 m/min. at 400 N; Max. 38 m/min. at 3,500 N

**Impact velocity range:** At speeds of 0.3 m/s the maximum allowed energy is approx. 1 Nm for units up to 55 mm stroke and approx. 2 Nm for units 75 mm to 125 mm stroke. Where higher energies occur use a shock absorber for the initial impact. Avoid high impact velocities.

**Adjustment:** Infinitely adjustable

**Positive stop:** External positive stops 1 mm to 1.5 mm before the end of stroke provided by the customer.

**Damping medium:** Oil, temperature stable

**Material:** Outer body: Black anodized aluminium; Piston rod: Hard chrome plated steel; Accessories: Steel with black oxide finish or nitride hardened

**Mounting:** In any position

**Operating temperature range:** 0 °C to 60 °C

**Application field:** Handling modules, Linear slides, Automatic machinery, Conveyor equipment, Absorption control

**Note:** Nylon button PP600 can be fitted onto piston rod. Unit may be mounted in any position.

**Safety instructions:** Do not rotate piston rod, if excessive rotation force is applied rolling seal may rupture. External materials in the surrounding area can attack the seal components and lead to a shorter service life. Please contact ACE for appropriate solution suggestions.

**On request:** Special oil and other special options available on request.

### VC25EUFT

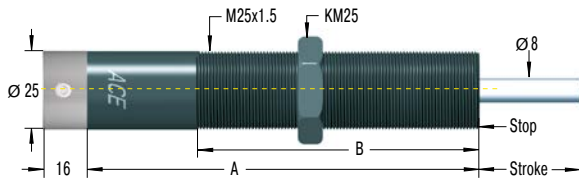

### SP25

#### Air Bleed Collar

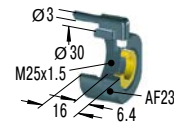

For VC2515FT to VC2555FT  
reduction of the stroke 6.4 mm

### MB25

#### Clamp Mount

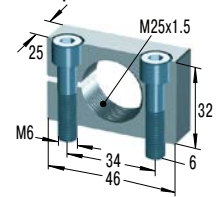

Additional accessories, mounting, installation ... see from page 42.

### Complete details required when ordering

Load to be decelerated:  $m$  (kg)  
Impact velocity:  $v$  (m/s)  
Propelling force:  $F$  (N)  
Operating cycles per hour:  $c$  (/hr)  
Number of absorbers in parallel:  $n$   
Ambient temperature:  $^{\circ}\text{C}$

### Ordering Example

Type (Feed Control) \_\_\_\_\_  
Thread Size M25 \_\_\_\_\_  
Stroke (55 mm) \_\_\_\_\_  
EU Compliant \_\_\_\_\_  
FT = with thread M25x1.5 \_\_\_\_\_  
F = without thread, plain body ( $\text{Ø}$  23.8 mm)

### VC 25 55 EUFT

### Performance and Dimensions

| TYPES       | Stroke<br>mm | A<br>mm | B<br>mm | Compression<br>force min.<br>N | Compression<br>force max.<br>N | Return Force<br>min.<br>N | Return Force<br>max.<br>N | Return Time<br>s | Side Load Angle<br>max.<br>° | Weight<br>kg |
|-------------|--------------|---------|---------|--------------------------------|--------------------------------|---------------------------|---------------------------|------------------|------------------------------|--------------|
| VC2515EUFT  | 15           | 128     | 80      | 30                             | 3,500                          | 15                        | 30                        | 0.2              | 3                            | 0.260        |
| VC2530EUFT  | 30           | 161     | 110     | 30                             | 3,500                          | 5                         | 30                        | 0.4              | 2                            | 0.470        |
| VC2555EUFT  | 55           | 209     | 130     | 35                             | 3,500                          | 5                         | 40                        | 1.2              | 2                            | 0.420        |
| VC2575EUFT  | 75           | 283     | 150     | 50                             | 3,500                          | 10                        | 50                        | 1.7              | 2                            | 0.701        |
| VC25100EUFT | 100          | 308     | 150     | 60                             | 3,500                          | 10                        | 50                        | 2.3              | 1                            | 0.814        |
| VC25125EUFT | 125          | 333.5   | 150     | 70                             | 3,500                          | 10                        | 60                        | 2.8              | 1                            | 0.928        |

Suffix FT: M25x1.5 threaded body.

Suffix F: plain body 23.8 mm dia. (without thread), with optional clamp type mounting block.

### Operating Range VC

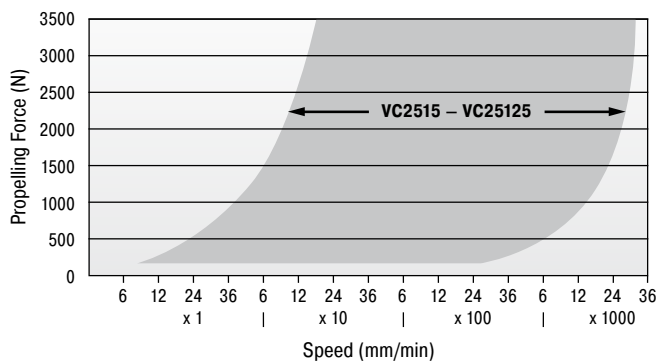

### Accessories with Mounting Example



Mounting with clamp mount MB25



Installed with air bleed collar SP25

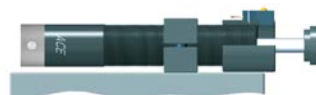

Installed with switch stop collar inc. proximity switch and steel button AS25 plus PS25

#### Alternative circlip grooves

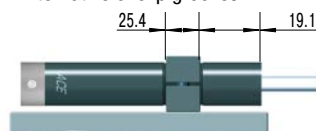

Bulkhead mounting for VC25...F with mounting block KB... (23.8 mm plain body option)



# MA, MVC

Designed for applications with low precision requirements

## Adjustable

**Compression force 8 N to 3,500 N**

**Stroke 7 mm to 40 mm**

Many application options: The hydraulic feed controls in models MA and MVC are similar to that of the VC model. However, these hydraulic controls have been designed for applications that require less precision.

There are also plenty of accessories for the MA and MVC models. All products are ready-to-install, maintenance-free, stable in temperature and avoids stick-slip effect. Speeds from 12 mm/min. can be driven at a low thrust force using the adjustment screw on the base of the hydraulic control.

Hydraulic feed controls with the designations MA and MVC are especially used in handling modules or linear carriages and also for applications with changing usage data.

### Operating Range MVC225 to MVC900

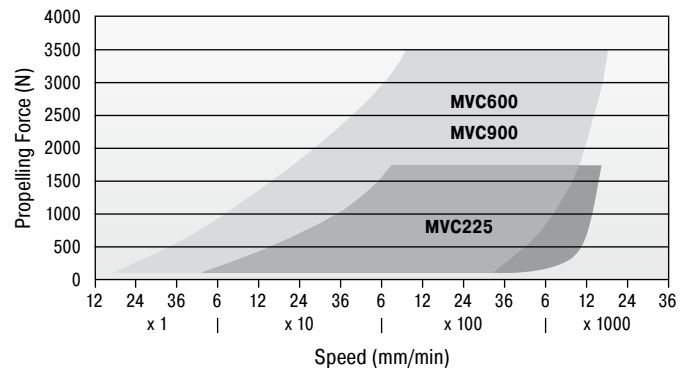

### Performance and Dimensions

| TYPES     | Stroke<br>mm | Compression force |           | Return Force min.<br>N | Return Force max.<br>N | Return Time<br>s | Side Load Angle<br>max. ° | Weight<br>kg |
|-----------|--------------|-------------------|-----------|------------------------|------------------------|------------------|---------------------------|--------------|
|           |              | min.<br>N         | max.<br>N |                        |                        |                  |                           |              |
| MA30EUM   | 8            | 8                 | 80        | 1.7                    | 5.3                    | 0.3              | 2.0                       | 0.011        |
| MA50EUM-B | 7.2          | 40                | 160       | 3.0                    | 6.0                    | 0.3              | 2.0                       | 0.025        |
| MA35EUM   | 10.2         | 15                | 200       | 5.0                    | 11.0                   | 0.2              | 2.0                       | 0.045        |
| MA150EUM  | 12.7         | 20                | 300       | 3.0                    | 5.0                    | 0.4              | 2.0                       | 0.061        |
| MVC225EUM | 19           | 25                | 1,750     | 5.0                    | 10.0                   | 0.65             | 2.0                       | 0.160        |
| MVC600EUM | 25           | 65                | 3,500     | 10.0                   | 30.0                   | 0.85             | 2.0                       | 0.320        |
| MVC900EUM | 40           | 70                | 3,500     | 10.0                   | 35.0                   | 0.95             | 2.0                       | 0.420        |

<sup>1</sup> For applications with higher side load angles consider using the side load adaptor (BV) pages 38 to 45.

### Technical Data

**Compression force:** 8 N to 3,500 N

**Execution:** Thread M8 to M25

**Impact velocity range:** At speeds of 0.3 m/s the maximum allowed energy is approx. 2 Nm. Where higher energies occur use a shock absorber for the initial impact. Avoid high impact velocities.

**Adjustment:** Hard impact at the start of stroke, turn towards 9 or PLUS. Hard impact at the end of stroke, turn towards 0 or MINUS.

**Positive stop:** Integrated

**Damping medium:** Oil, temperature stable

**Material:** Outer body: Nitride hardened steel; Piston rod: Steel with black oxide finish or nitride hardened

**Mounting:** In any position

**Operating temperature range:** 0 °C to 66 °C

**Application field:** Handling modules, Linear slides, Automatic machinery, Conveyor equipment, Absorption control

**Note:** Damper is preset at delivery in a neutral position between hard and soft.

**Safety instructions:** External materials in the surrounding area can attack the seal components and lead to a shorter service life. Please

contact ACE for appropriate solution suggestions.

**On request:** Nickel-plated, weartec finish (seawater resistant) or other special options available on request.

### MA30EUM

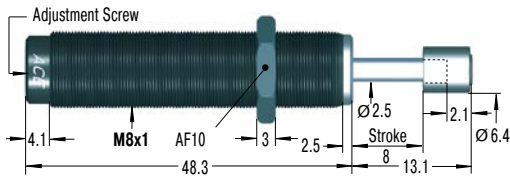

### RF8 Rectangular Flange

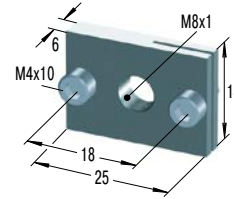

### MB8SC2 Mounting Block

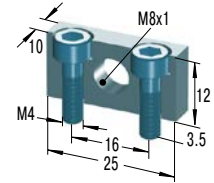

### MA50EUM-B

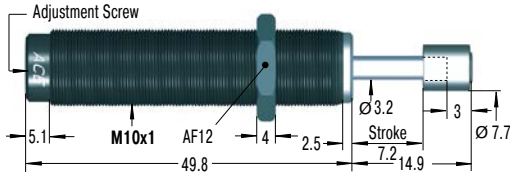

### RF10 Rectangular Flange

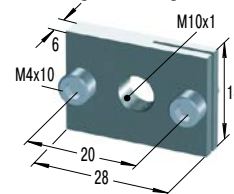

### MB10SC2 Mounting Block

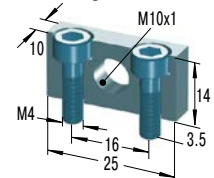

### MA35EUM

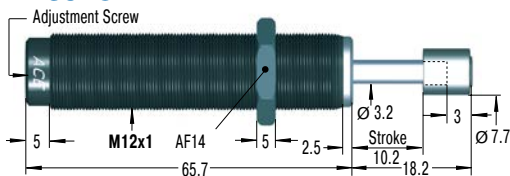

### RF12 Rectangular Flange

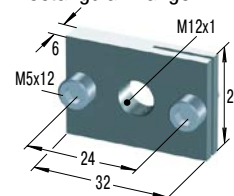

### MB12 Clamp Mount

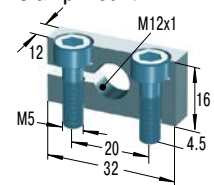

### MA150EUM

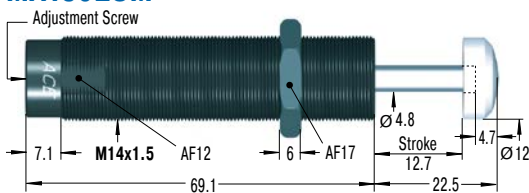

### RF14 Rectangular Flange

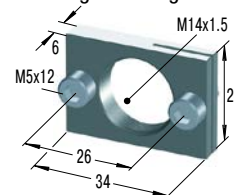

### MB14 Clamp Mount

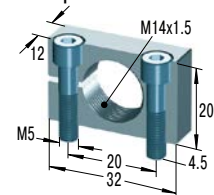

### MVC225EUM

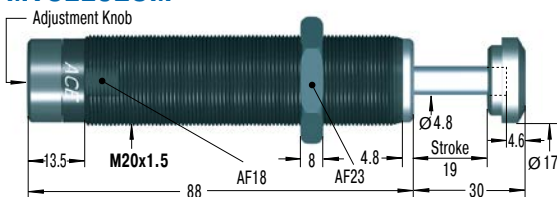

### RF20 Rectangular Flange

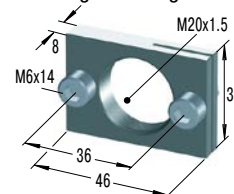

### MB20 Clamp Mount

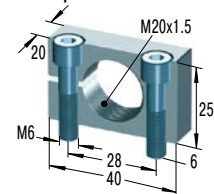

### MVC600EUM

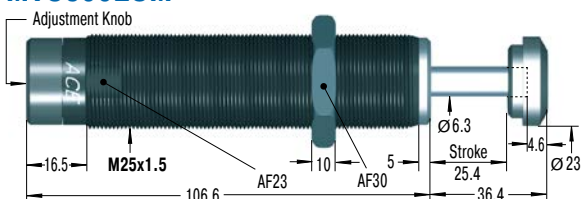

### RF25 Rectangular Flange

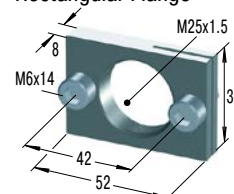

### MB25 Clamp Mount

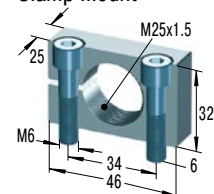

### MVC900EUM

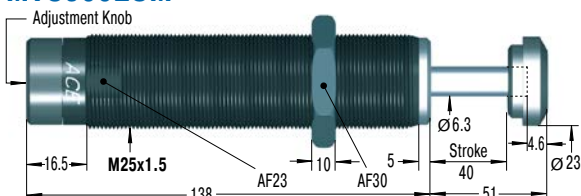

### RF25 Rectangular Flange

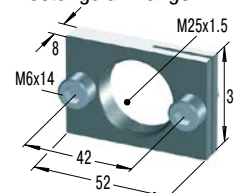

### MB25 Clamp Mount

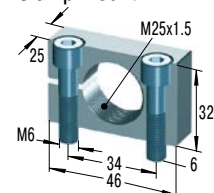

Additional accessories, mounting, installation ... see from page 38.

# Rotary Dampers

## Small dampers refine end product

**ACE rotary dampers mainly provide an invisible yet valuable service as a maintenance-free machine element to allow controlled deceleration of rotary or linear movements.**

They are often necessary to make careful opening and closing of small lids, compartments and drawers possible and they protect sensitive components while increasing the quality and value of products. They are easy to integrate. The harmoniously gentle movements of these little decelerators can be achieved with continual rotation or with limited pivoting angles. They slow down left, right or double sided rotation. Suitable for almost any application and currently also available in adjustable variations, they provide braking torques of 0.05 Ncm to 40 Nm.

**Partial Rotation Angle, Adjustable**  
e.g. FYT-H1 and FYN-H1

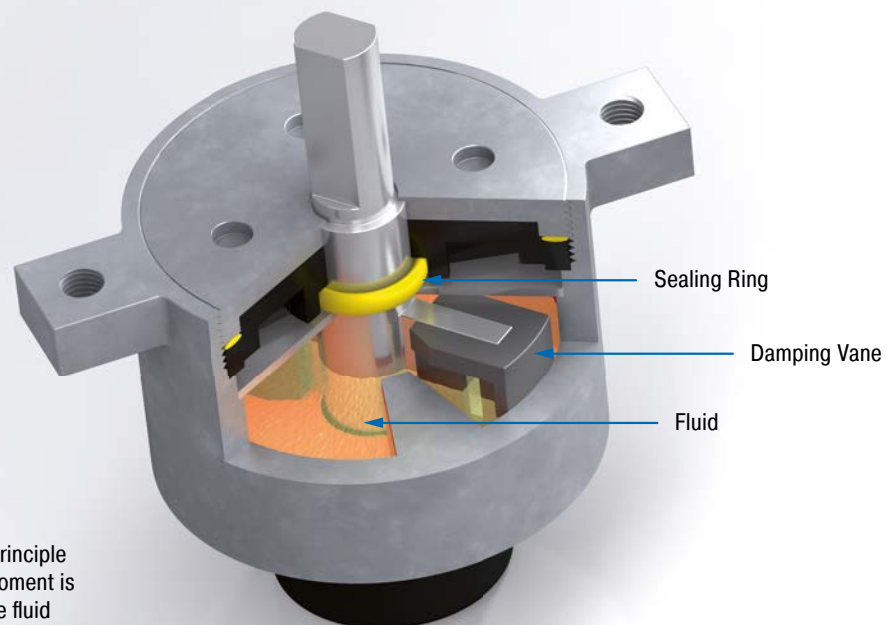

### General Function

Rotary dampers operate on the principle of fluid damping. The damping moment is determined by the viscosity of the fluid and the dimensioning of the throttle gap or throttle orifices.



### Rotary Dampers with Continuous Rotation

Rotate for the plus in quality: For smooth, quiet movements of small hoods, flaps and fans these continuously rotating rotary dampers from ACE decelerate either right, left or two-sided rotation right in the pivot point or linear through a gear and gear rack. The harmoniously gentle process protects components and increases the quality and value of products. The maintenance-free, ready-to-install ACE rotary dampers are filled with an inert fluid, usually silicone oil. The viscosity of the fluid and the sizing of the throttling gap determine the damping torque. The FFD series is the only exception: These fluid-free rotary dampers operate according to the principle of friction.

The continuously rotating rotary dampers with the designations FRT, FRN, FFD, FDT and FDN are used in household and medical devices as well as in the automotive, electronics and furniture industries.



### Rotary Dampers with Partial Rotation Angle

For controlled and gentle deceleration: The damping direction of this rotary damper, which is available with adjustable damping torque, can be right, left or two-sided rotation. They can be installed directly in the pivot point of a construction and achieve uniform, quiet movements, which increases quality and value and protects sensitive components. The products are maintenance-free, ready-to-install and filled with an inert fluid, usually silicone oil. A rotor movement presses the fluid from one chamber into the other. The damping torque is determined by the viscosity of the fluid and the sizing of the throttling gap the throttle holes. During each reversal of movement, depending on the frame size a certain return damping torque develops.

These solutions are used in the automotive sector, in many industrial applications, in the electronics and furniture industries as well as in medical devices.

High protection of sensitive components

Various designs for every application

Maintenance-free and ready-to-install

#### Partial Rotation Angle

e.g. FYN-N1

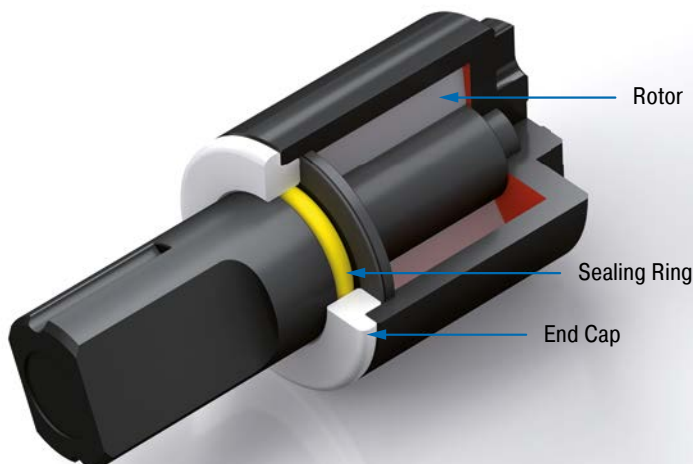

#### Continuous Rotation

e.g. FRT-E2

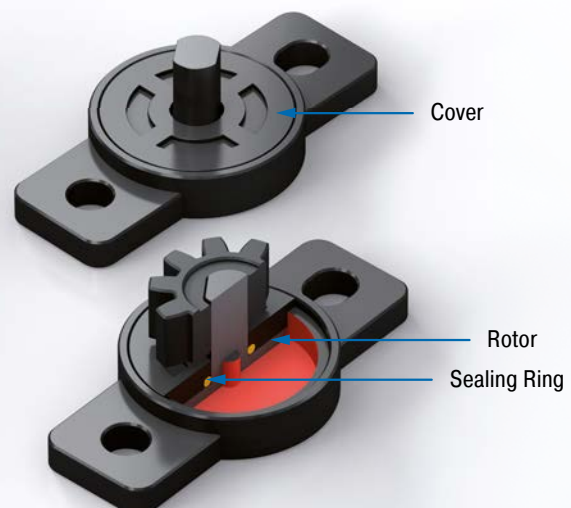



## Rotary Dampers

### kontinuierlich drehend



#### FRT-E2

Continuous Rotation  
**Small and lightweight for finest braking**

Page 224



#### FRT-G2

Continuous Rotation  
**Small and lightweight for finest braking**

Page 225



#### FRT-C2 and FRN-C2

Continuous Rotation  
**Flexible and cost efficient use**

Page 226



#### FRT-D2 and FRN-D2

Continuous Rotation  
**Flexible and cost efficient use**

Page 227



#### FRT-F2/K2 and FRN-F2/K2

Continuous Rotation  
**For very long service life extension**

Page 228



#### FFD

Continuous Rotation  
**Precise braking without oil**

Page 229



#### FDT

Continuous Rotation  
**The flat disc brake for two-sided damping**

Page 230



#### FDN

Continuous Rotation  
**The flat disc brake for one direction of rotation**

Page 231



## Rotary Dampers

### Partial rotation angle



#### FYN-P1

Page 232

Partial Rotation Angle  
**Small diameter, large damping torques**



#### FYN-N1

Page 233

Partial Rotation Angle  
**Small diameter, large damping torques**



#### FYN-U1

Page 234

Partial Rotation Angle  
**Small, strong and very robust**



#### FYN-S1

Page 235

Partial Rotation Angle  
**The flat damper for constant component protection**



### Partial rotation angle, adjustable



#### FYT-H1 and FYN-H1

Page 236

Partial Rotation Angle, Adjustable  
**Specifically adjustable, strong braking force**



#### FYT-LA3 and FYN-LA3

Page 237

Partial Rotation Angle, Adjustable  
**Adjustable high performance**



# FRT-E2

Small and lightweight for finest braking

## Continuous Rotation

Damping torque 0.1 Ncm to 0.4 Ncm

The damping direction of the smallest ACE FRT-E2 rotary dampers with plastic body is rotating on both sides. They can brake directly in the pivot point or linear through a gear and gear rack. ACE rotary dampers are maintenance-free and ready-to-install.



## Technical Data

**Construction size:** Ø 10 mm

**Rotational speed max.:** 50 rpm

**Lifetime:** 50,000 cycles (1 cycle = 360° left-hand, 360° right-hand). Even after this time, the dampers still produce over approx. 80 % of their original damping moment. The service life may be significantly higher or lower, depending on the application.

**Operating temperature range:** 0 °C to +50 °C

**Pressure angle:** 20°

**Material:** Outer body, Shaft, Gear: Plastic

**Mounting:** In any position

**Tooth:** Involute gearing

**P.C.D.:** 6 mm

**No. of teeth:** 10

**Module:** 0.6

**Mounting information:** No axial or radial forces may be induced via the shaft.

**Safety instructions:** Do not use rotary dampers as supports. Provide an external guide or support.

**On request:** Special designs available on request. Toothed plastic racks (modules 0.5 to 1.0) are available for the rotary dampers with pinions.

## Characteristics

At 23 °C ambient temperature

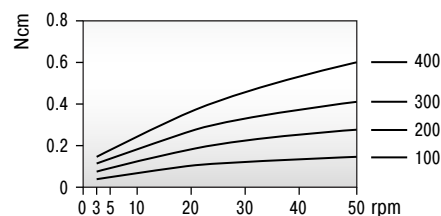

At 20 rpm rotational speed

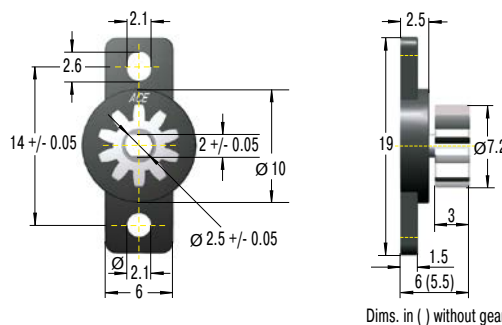
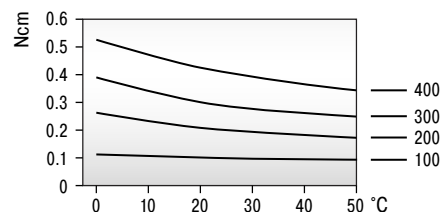

## Performance

| TYPES         | <sup>1</sup> Damping torque<br>Ncm | Damping direction | Gear    | Weight<br>kg |
|---------------|------------------------------------|-------------------|---------|--------------|
| FRT-E2-100    | 0.10 +/- 0.05                      | bidirectional     | without | 0.00032      |
| FRT-E2-200    | 0.20 +/- 0.07                      | bidirectional     | without | 0.00032      |
| FRT-E2-300    | 0.30 +/- 0.08                      | bidirectional     | without | 0.00032      |
| FRT-E2-400    | 0.40 +/- 0.10                      | bidirectional     | without | 0.00032      |
| FRT-E2-100-G1 | 0.10 +/- 0.05                      | bidirectional     | with    | 0.00041      |
| FRT-E2-200-G1 | 0.20 +/- 0.07                      | bidirectional     | with    | 0.00041      |
| FRT-E2-300-G1 | 0.30 +/- 0.08                      | bidirectional     | with    | 0.00041      |
| FRT-E2-400-G1 | 0.40 +/- 0.10                      | bidirectional     | with    | 0.00041      |

<sup>1</sup> The indicated damping torque refers to a rotational speed of 20 rpm and an ambient temperature of 23 °C.

### FRT-G2

Small and lightweight for finest braking

#### Continuous Rotation

Damping torque 0.2 Ncm to 1 Ncm

The damping direction of the ACE FRT-G2 product family with plastic body is rotating on both sides. The small rotary dampers can brake directly in the pivot point or linear through a gear and gear rack. ACE rotary dampers are maintenance-free and ready-to-install.



#### Technical Data

**Construction size:** Ø 15 mm

**Rotational speed max.:** 50 rpm

**Lifetime:** 50,000 cycles (1 cycle = 360° left-hand, 360° right-hand). Even after this time, the dampers still produce over approx. 80 % of their original damping moment. The service life may be significantly higher or lower, depending on the application.

**Operating temperature range:** 0 °C to +50 °C

**Pressure angle:** 20°

**Material:** Outer body, Shaft, Gear: Plastic

**Mounting:** In any position

**Tooth:** Involute gearing

**P.C.D.:** 7 mm

**No. of teeth:** 14

**Module:** 0.5

**Mounting information:** No axial or radial forces may be induced via the shaft.

**Safety instructions:** Do not use rotary dampers as supports. Provide an external guide or support.

**On request:** Special designs available on request. Toothed plastic racks (modules 0.5 to 1.0) are available for the rotary dampers with pinions.

#### Characteristics

At 23 °C ambient temperature

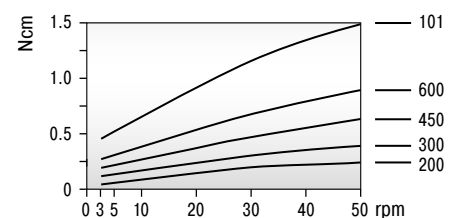

At 20 rpm rotational speed

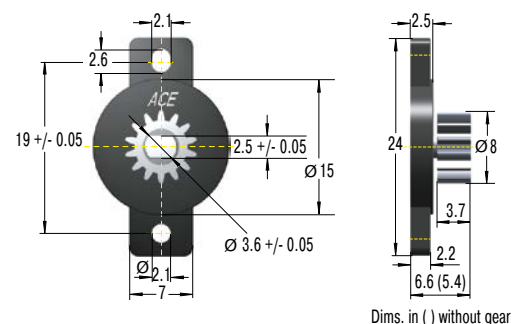
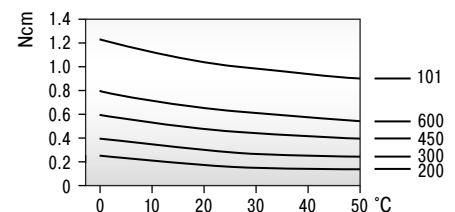

#### Performance

| TYPES         | <sup>1</sup> Damping torque<br>Ncm | Damping direction | Gear    | Weight<br>kg |
|---------------|------------------------------------|-------------------|---------|--------------|
| FRT-G2-200    | 0.20 +/- 0.07                      | bidirectional     | without | 0.00060      |
| FRT-G2-300    | 0.30 +/- 0.08                      | bidirectional     | without | 0.00060      |
| FRT-G2-450    | 0.45 +/- 0.10                      | bidirectional     | without | 0.00060      |
| FRT-G2-600    | 0.60 +/- 0.12                      | bidirectional     | without | 0.00060      |
| FRT-G2-101    | 1.00 +/- 0.20                      | bidirectional     | without | 0.00060      |
| FRT-G2-200-G1 | 0.20 +/- 0.07                      | bidirectional     | with    | 0.00080      |
| FRT-G2-300-G1 | 0.30 +/- 0.08                      | bidirectional     | with    | 0.00080      |
| FRT-G2-450-G1 | 0.45 +/- 0.10                      | bidirectional     | with    | 0.00080      |
| FRT-G2-600-G1 | 0.60 +/- 0.12                      | bidirectional     | with    | 0.00080      |
| FRT-G2-101-G1 | 1.00 +/- 0.20                      | bidirectional     | with    | 0.00080      |

<sup>1</sup> The indicated damping torque refers to a rotational speed of 20 rpm and an ambient temperature of 23 °C.

## FRT-C2 and FRN-C2

Flexible and cost efficient use

### Continuous Rotation

### Damping torque 2 Ncm to 3 Ncm

The damping direction of the simple FRT-C2 and FRN-C2 is either right, left or two-sided rotation. These ACE rotary dampers with plastic body can decelerate directly in the pivot point or linear through a gear and gear rack. ACE rotary dampers are maintenance-free and ready-to-install.



### Technical Data

**Construction size:** Ø 15 mm

**Rotational speed max.:** 50 rpm

**Lifetime:** 50,000 cycles (1 cycle = 360° left-hand, 360° right-hand). Even after this time, the dampers still produce over approx. 80 % of their original damping moment. The service life may be significantly higher or lower, depending on the application.

**Operating temperature range:** 0 °C to +50 °C

**Pressure angle:** 20°

**Material:** Outer body, Gear: Plastic; Shaft: Plastic, steel

**Mounting:** In any position

**Tooth:** Involute gearing

**P.C.D.:** 8.8 mm

**No. of teeth:** 11

**Module:** 0.8

**Mounting information:** No axial or radial forces may be induced via the shaft.

**Safety instructions:** Do not use rotary dampers as supports. Provide an external guide or support.

**On request:** Special designs available on request. Toothed plastic racks (modules 0.5 to 1.0) are available for the rotary dampers with pinions.

### Characteristics

#### At 23 °C ambient temperature

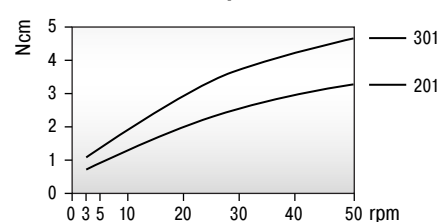

#### At 20 rpm rotational speed

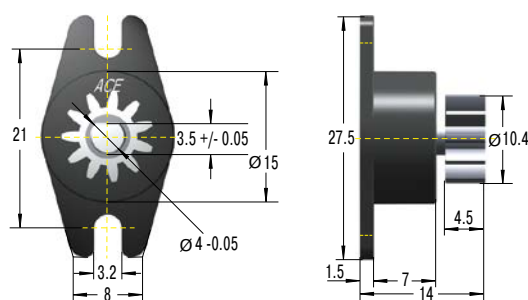
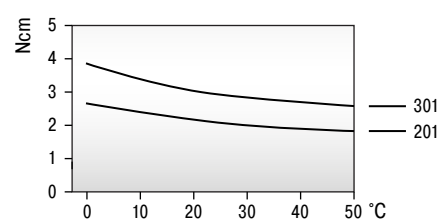

### Performance

| TYPES          | <sup>1</sup> Damping torque<br>Ncm | Damping direction | Gear    | Weight<br>kg |
|----------------|------------------------------------|-------------------|---------|--------------|
| FRT-C2-201     | 2 +/- 0.6                          | bidirectional     | without | 0.002        |
| FRT-C2-301     | 3 +/- 0.8                          | bidirectional     | without | 0.002        |
| FRT-C2-201-G1  | 2 +/- 0.6                          | bidirectional     | with    | 0.002        |
| FRT-C2-301-G1  | 3 +/- 0.8                          | bidirectional     | with    | 0.002        |
| FRN-C2-R201    | 2 +/- 0.6                          | right             | without | 0.002        |
| FRN-C2-R301    | 3 +/- 0.8                          | right             | without | 0.003        |
| FRN-C2-R201-G1 | 2 +/- 0.6                          | right             | with    | 0.002        |
| FRN-C2-R301-G1 | 3 +/- 0.8                          | right             | with    | 0.004        |
| FRN-C2-L201    | 2 +/- 0.6                          | left              | without | 0.002        |
| FRN-C2-L301    | 3 +/- 0.8                          | left              | without | 0.003        |
| FRN-C2-L201-G1 | 2 +/- 0.6                          | left              | with    | 0.002        |
| FRN-C2-L301-G1 | 3 +/- 0.8                          | left              | with    | 0.003        |

<sup>1</sup> The indicated damping torque refers to a rotational speed of 20 rpm and an ambient temperature of 23 °C.

## FRT-D2 and FRN-D2

Flexible and cost efficient use

### Continuous Rotation

Damping torque 5 Ncm to 15 Ncm

The damping direction of the ACE FRT-D2 and FRN-D2 rotary dampers with plastic body is either the right, left or two-sided rotation. They can decelerate directly in the pivot point or linear through a gear and gear rack. ACE rotary dampers are maintenance-free and ready-to-install.



### Technical Data

**Construction size:** Ø 25 mm

**Rotational speed max.:** 50 rpm

**Lifetime:** 50,000 cycles (1 cycle = 360° left-hand, 360° right-hand). Even after this time, the dampers still produce over approx. 80 % of their original damping moment. The service life may be significantly higher or lower, depending on the application.

**Operating temperature range:** 0 °C to +50 °C

**Pressure angle:** 20°

**Material:** Outer body, Gear: Plastic; Shaft: Plastic, steel

**Mounting:** In any position

**Tooth:** Involute gearing (addendum modification coefficient: +0.375)

**P.C.D.:** 12 mm

**No. of teeth:** 12

**Module:** 1

**Mounting information:** No axial or radial forces may be induced via the shaft.

**Safety instructions:** Do not use rotary dampers as supports. Provide an external guide or support.

**On request:** Special designs available on request. Toothed plastic racks (modules 0.5 to 1.0) are available for the rotary dampers with pinions.

### Characteristics

At 23 °C ambient temperature

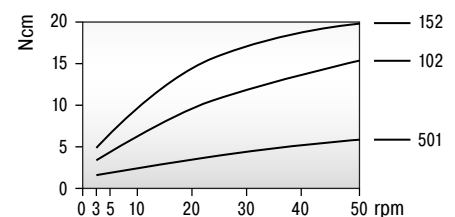

At 20 rpm rotational speed

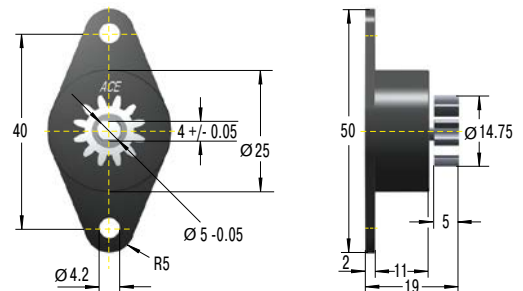
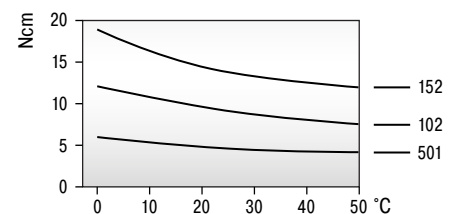

### Performance

| TYPES          | <sup>1</sup> Damping torque<br>Ncm | Damping direction | Gear    | Weight<br>kg |
|----------------|------------------------------------|-------------------|---------|--------------|
| FRT-D2-102     | 10 +/- 2                           | bidirectional     | without | 0.008        |
| FRT-D2-152     | 15 +/- 3                           | bidirectional     | without | 0.008        |
| FRT-D2-501     | 5 +/- 1                            | bidirectional     | without | 0.008        |
| FRT-D2-102-G1  | 10 +/- 2                           | bidirectional     | with    | 0.009        |
| FRT-D2-152-G1  | 15 +/- 3                           | bidirectional     | with    | 0.009        |
| FRT-D2-501-G1  | 5 +/- 1                            | bidirectional     | with    | 0.009        |
| FRN-D2-R102    | 10 +/- 2                           | right             | without | 0.012        |
| FRN-D2-R152    | 15 +/- 3                           | right             | without | 0.012        |
| FRN-D2-R501    | 5 +/- 1                            | right             | without | 0.012        |
| FRN-D2-R102-G1 | 10 +/- 2                           | right             | with    | 0.012        |
| FRN-D2-R152-G1 | 15 +/- 3                           | right             | with    | 0.012        |
| FRN-D2-R501-G1 | 5 +/- 1                            | right             | with    | 0.012        |
| FRN-D2-L102    | 10 +/- 2                           | left              | without | 0.012        |
| FRN-D2-L152    | 15 +/- 3                           | left              | without | 0.012        |
| FRN-D2-L501    | 5 +/- 1                            | left              | without | 0.012        |
| FRN-D2-L102-G1 | 10 +/- 2                           | left              | with    | 0.012        |
| FRN-D2-L152-G1 | 15 +/- 3                           | left              | with    | 0.012        |
| FRN-D2-L501-G1 | 5 +/- 1                            | left              | with    | 0.012        |

<sup>1</sup> The indicated damping torque refers to a rotational speed of 20 rpm and an ambient temperature of 23 °C.

# FRT-F2/K2 and FRN-F2/K2

For very long service life extension

## Continuous Rotation

Damping torque 200 Ncm to 400 Ncm

The damping direction of FRT F2/K2 and FRN-F2/K2 is either the right, left or two-sided rotation. With a damping torque of up to 400 Ncm, this product family can even handle heavy components. These ACE rotary dampers can decelerate directly in the pivot point or linear through a gear and gear rack. They are maintenance-free and ready-to-install.



### Technical Data

**Construction size:** Ø 40 mm

**Rotational speed max.:** 50 rpm

**Lifetime:** 50,000 cycles (1 cycle = 360° left-hand, 360° right-hand). Even after this time, the dampers still produce over approx. 80 % of their original damping moment. The service life may be significantly higher or lower, depending on the application.

**Operating temperature range:** 0 °C to +50 °C

**Material:** Outer body: Plastic; Shaft: Steel

**Mounting:** In any position

**Mounting information:** No axial or radial forces may be induced via the shaft.

**Safety instructions:** Do not use rotary dampers as supports. Provide an external guide or support.

**On request:** Special designs available on request.

### Characteristics

At 23 °C ambient temperature

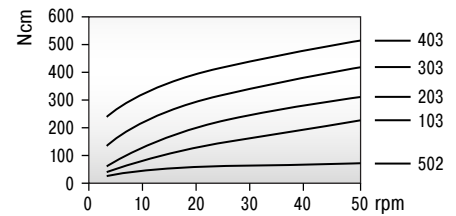

At 20 rpm rotational speed

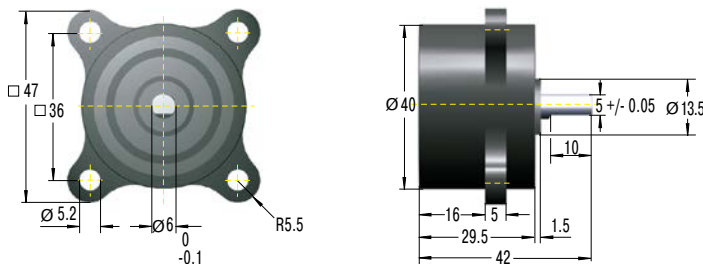
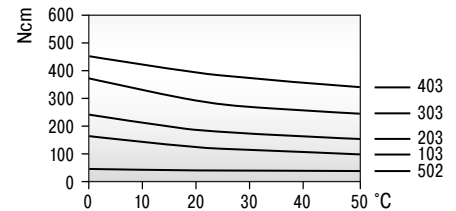

### Performance

| TYPES       | <sup>1</sup> Damping torque<br>Ncm | Damping direction | Weight<br>kg |
|-------------|------------------------------------|-------------------|--------------|
| FRT-K2-502  | 50 +/- 10                          | bidirectional     | 0.080        |
| FRT-K2-103  | 100 +/- 20                         | bidirectional     | 0.080        |
| FRT-F2-203  | 200 +/- 40                         | bidirectional     | 0.115        |
| FRT-F2-303  | 300 +/- 80                         | bidirectional     | 0.115        |
| FRT-F2-403  | 400 +/- 100                        | bidirectional     | 0.115        |
| FRN-K2-R502 | 50 +/- 10                          | right             | 0.057        |
| FRN-K2-R103 | 100 +/- 20                         | right             | 0.057        |
| FRN-F2-R203 | 200 +/- 40                         | right             | 0.090        |
| FRN-K2-L502 | 50 +/- 10                          | left              | 0.057        |
| FRN-K2-L103 | 100 +/- 20                         | left              | 0.057        |
| FRN-F2-L203 | 200 +/- 40                         | left              | 0.090        |

<sup>1</sup> The indicated damping torque refers to a rotational speed of 20 rpm and an ambient temperature of 23 °C.

### FFD

Precise braking without oil

#### Continuous Rotation

Damping torque 0.1 Nm to 3 Nm

In comparison to other rotary dampers, the ACE FFD product family does not need any fluid to generate the damping torque, but rather works on the principle of friction. That means temperature or speed changes have virtually no influence on the damping torque. The FFD is available in two different body variants and two types of bearings. ACE rotary dampers are maintenance-free and ready-to-install.



#### Technical Data

**Construction size:** Ø 25 mm to 30 mm

**Rotational speed max.:** 30 rpm

**Lifetime:** 30,000 cycles (1 cycle = 360° left-hand, 360° right-hand). Even after this time, the dampers still produce over approx. 80 % of their original damping moment. The service life may be significantly higher or lower, depending on the application.

**Operating temperature range:** -10 °C to +60 °C

**Material:** Outer body: Plastic

**Mounting:** In any position

**Information to the shaft:** Ø +0 / -0.03

Hardness > HRC55, surface smoothness RZ<1µm

**Mounting information:** Turn the shaft in the opposite direction to the brake direction to avoid damaging the freewheel mount. No axial or radial forces may be induced via the shaft.

**Safety instructions:** Do not use rotary dampers as supports. Provide an external guide or support.

**On request:** Special designs available on request.

#### Ordering Example

Friction Damper \_\_\_\_\_  
 Body Ø \_\_\_\_\_  
 Mounting Style (flange = F, standard = S) \_\_\_\_\_  
 Model (standard = S, high = W) \_\_\_\_\_  
 Damping Direction (right = R, left = L) \_\_\_\_\_  
 Damping Torque see chart \_\_\_\_\_

**FFD-25-FS-L-102**

#### Complete details required when ordering

- Damping torque 102 = 0.1 Nm
- Damping torque 502 = 0.5 Nm
- Damping torque 103 = 1.0 Nm
- Damping torque 153 = 1.5 Nm
- Damping torque 203 = 2.0 Nm
- Damping torque 253 = 2.5 Nm
- Damping torque 303 = 3.0 Nm
- Note dimension C.

#### Model Type Prefix

FS = Mounting Style with Flange, Model standard

FW = Mounting Style with Flange, Model high

SS = Mounting Style Standard, Model standard

SW = Mounting Style Standard, Model high

Combinations with W for higher damping torque.

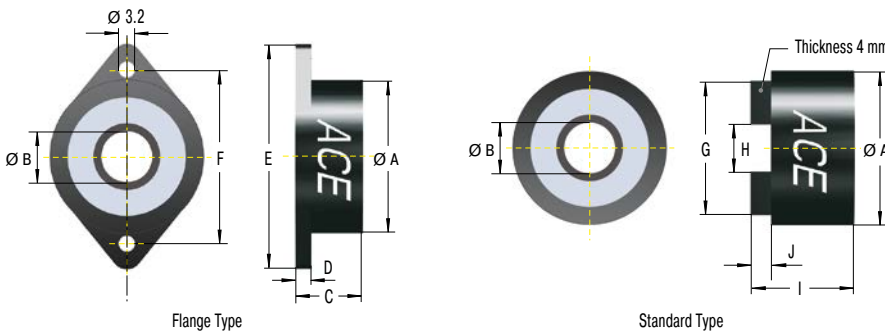

#### Performance and Dimensions

| TYPES    | <sup>1</sup> Damping torque<br>Nm | Damping direction | Model | A<br>mm | B<br>mm | C<br>mm | D<br>mm | E<br>mm | F<br>mm | G<br>mm | H<br>mm | I<br>mm | J<br>mm | Weight<br>kg |
|----------|-----------------------------------|-------------------|-------|---------|---------|---------|---------|---------|---------|---------|---------|---------|---------|--------------|
| FFD-25SS | 0.1/0.5/1.0                       | right or left     | SS    | 25      | 6       | 13      | 3       | 42      | 34      | 21      | 6.2     | 16      | 4       | 0.012        |
| FFD-28SS | 0.1/0.5/1.0                       | right or left     | SS    | 28      | 8       | 13      | 3       | 44      | 36      | 24      | 8.2     | 16      | 4       | 0.014        |
| FFD-30SS | 0.1/0.5/1.0/1.5                   | right or left     | SS    | 30      | 10      | 13      | 3       | 46      | 38      | 26      | 10.2    | 16      | 4       | 0.016        |
| FFD-25FS | 0.1/0.5/1.0                       | right or left     | FS    | 25      | 6       | 13      | 3       | 42      | 34      | 21      | 6.2     | 16      | 4       | 0.013        |
| FFD-28FS | 0.1/0.5/1.0                       | right or left     | FS    | 28      | 8       | 13      | 3       | 44      | 36      | 24      | 8.2     | 16      | 4       | 0.014        |
| FFD-30FS | 0.1/0.5/1.0/1.5                   | right or left     | FS    | 30      | 10      | 13      | 3       | 46      | 38      | 26      | 10.2    | 16      | 4       | 0.017        |
| FFD-25SW | 1.0/1.5/2.0                       | right or left     | SW    | 25      | 6       | 19      | 3       | 42      | 34      | 21      | 6.2     | 22      | 4       | 0.023        |
| FFD-28SW | 1.0/1.5/2.0                       | right or left     | SW    | 28      | 8       | 19      | 3       | 44      | 36      | 24      | 8.2     | 22      | 4       | 0.025        |
| FFD-30SW | 1.5/2.0/2.5/3.0                   | right or left     | SW    | 30      | 10      | 19      | 3       | 46      | 38      | 26      | 10.2    | 22      | 4       | 0.030        |
| FFD-25FW | 1.0/1.5/2.0                       | right or left     | FW    | 25      | 6       | 19      | 3       | 42      | 34      | 21      | 6.2     | 22      | 4       | 0.024        |
| FFD-28FW | 1.0/1.5/2.0                       | right or left     | FW    | 28      | 8       | 19      | 3       | 44      | 36      | 24      | 8.2     | 22      | 4       | 0.027        |
| FFD-30FW | 1.5/2.0/2.5/3.0                   | right or left     | FW    | 30      | 10      | 19      | 3       | 46      | 38      | 26      | 10.2    | 22      | 4       | 0.031        |

<sup>1</sup> The indicated damping torque refers to a rotational speed of 20 rpm and an ambient temperature of 23 °C.



# FDT

The flat disc brake for two-sided damping

## Continuous Rotation

Damping torque 2 Nm to 8.7 Nm

The damping direction of the flat constructive ACE rotary damper FDT with robust steel body is two-sided rotation. It can brake directly in the pivot point of the square receptacle. ACE rotary dampers are maintenance-free and ready-to-install.



### Technical Data

**Construction size:** Ø 47 mm to 70 mm

**Rotational speed max.:** 50 rpm

**Lifetime:** 50,000 cycles (1 cycle = 360° left-hand, 360° right-hand). Even after this time, the dampers still produce over approx. 80 % of their original damping moment. The service life may be significantly higher or lower, depending on the application.

**Operating temperature range:** -10 °C to +50 °C

**Material:** Outer body: Steel; Output shaft sleeve: Nylon

**Mounting:** In any position

**Mounting information:** No axial or radial forces may be induced via the shaft.

**Safety instructions:** Do not use rotary dampers as supports. Provide an external guide or support.

**On request:** Special designs available on request.

### Characteristics

At 23 °C ambient temperature

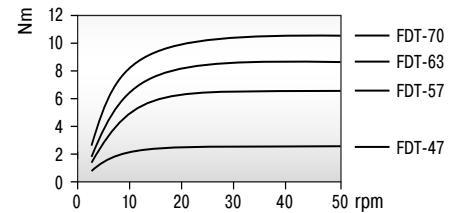

At 20 rpm rotational speed

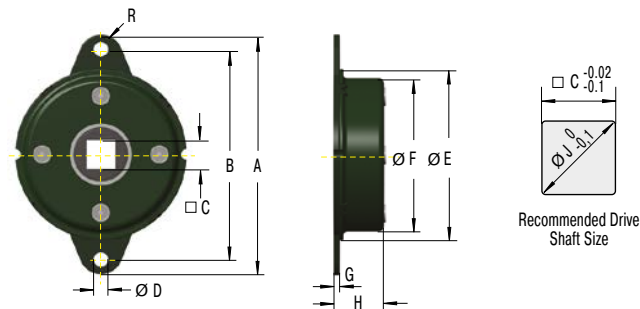
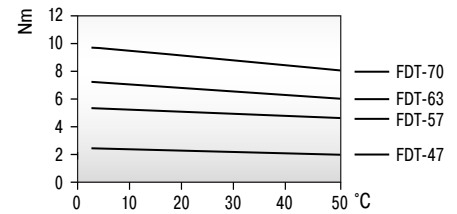

### Performance and Dimensions

| TYPES  | <sup>1</sup> Damping torque<br>Nm | Damping direction | A<br>mm | B<br>mm | C<br>mm | D<br>mm | E<br>mm | F<br>mm | G<br>mm | H<br>mm | R<br>mm | J<br>mm | Weight<br>kg |
|--------|-----------------------------------|-------------------|---------|---------|---------|---------|---------|---------|---------|---------|---------|---------|--------------|
| FDT-47 | 2.0 +/- 0.3                       | bidirectional     | 65      | 56      | 8       | 4.5     | 47      | 42.8    | 1.6     | 10.3    | 4.5     | 10      | 0.050        |
| FDT-57 | 4.7 +/- 0.5                       | bidirectional     | 79      | 68      | 10      | 5.5     | 57      | 52.4    | 1.6     | 11.2    | 5.5     | 13      | 0.075        |
| FDT-63 | 6.7 +/- 0.7                       | bidirectional     | 89      | 76      | 12.5    | 6.5     | 63      | 58.6    | 1.6     | 11.3    | 6.5     | 17      | 0.095        |
| FDT-70 | 8.7 +/- 0.8                       | bidirectional     | 95      | 82      | 12.5    | 6.5     | 70      | 65.4    | 1.6     | 11.3    | 6.5     | 17      | 0.110        |

<sup>1</sup> The indicated damping torque refers to a rotational speed of 20 rpm and an ambient temperature of 23 °C.

## FDN

The flat disc brake for one direction of rotation

### Continuous Rotation

Damping torque 2 Nm to 11 Nm

The damping direction of the flat, strong FDN rotary dampers with steel body can be either right or left rotation. They can brake directly in the pivot point. ACE rotary dampers are maintenance-free and ready-to-install.



### Technical Data

**Construction size:** Ø 47 mm to 70 mm

**Rotational speed max.:** 50 rpm

**Lifetime:** 50,000 cycles (1 cycle = 360° left-hand, 360° right-hand). Even after this time, the dampers still produce over approx. 80 % of their original damping moment. The service life may be significantly higher or lower, depending on the application.

**Operating temperature range:** -10 °C to +50 °C

**Material:** Outer body: Steel

**Mounting:** In any position

**Information to the shaft:**

FDN-47: Ø 6 +0 / -0.03

FDN-57 to FDN-70: Ø 10 +0 / -0.03

Hardness > HRC55, surface smoothness  $R_z < 1\mu\text{m}$

**Mounting information:** Turn the shaft in the opposite direction to the brake direction to avoid damaging the freewheel mount. No axial or radial forces may be induced via the shaft.

**Safety instructions:** Do not use rotary dampers as supports. Provide an external guide or support.

**On request:** Special designs available on request.

### Characteristics

At 23 °C ambient temperature

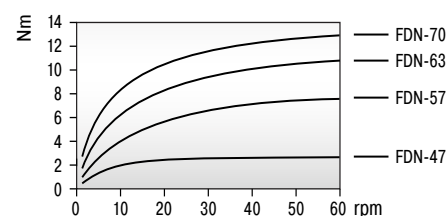

At 20 rpm rotational speed

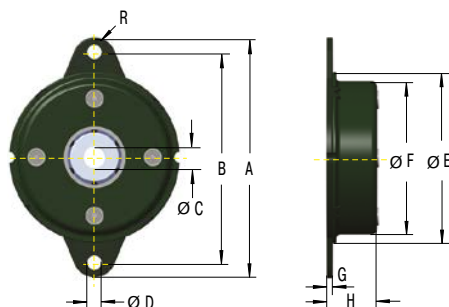
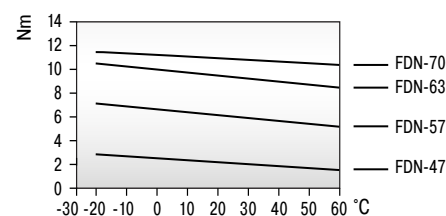

### Performance and Dimensions

| TYPES    | ¹ Damping torque<br>Nm | Damping direction | A  | B  | C  | D   | E  | F    | G   | H    | R   | Weight<br>kg |
|----------|------------------------|-------------------|----|----|----|-----|----|------|-----|------|-----|--------------|
|          |                        |                   | mm | mm | mm | mm  | mm | mm   | mm  | mm   | mm  |              |
| FDN-47-R | 2.0 +/- 0.3            | right             | 65 | 56 | 6  | 4.5 | 47 | 42.8 | 1.6 | 10.3 | 4.5 | 0.055        |
| FDN-57-R | 5.5 +/- 0.3            | right             | 79 | 68 | 10 | 5.5 | 57 | 52.4 | 1.6 | 14   | 5.5 | 0.095        |
| FDN-63-R | 8.5 +/- 0.8            | right             | 89 | 76 | 10 | 6.5 | 63 | 58.6 | 1.6 | 13.9 | 6.5 | 0.115        |
| FDN-70-R | 11.0 +/- 1.0           | right             | 95 | 82 | 10 | 6.5 | 70 | 65.4 | 1.6 | 13   | 6.5 | 0.135        |
| FDN-47-L | 2.0 +/- 0.3            | left              | 65 | 56 | 6  | 4.5 | 47 | 42.8 | 1.6 | 10.3 | 4.5 | 0.055        |
| FDN-57-L | 5.5 +/- 0.3            | left              | 79 | 68 | 10 | 5.5 | 57 | 52.4 | 1.6 | 14   | 5.5 | 0.095        |
| FDN-63-L | 8.5 +/- 0.8            | left              | 89 | 76 | 10 | 6.5 | 63 | 58.6 | 1.6 | 13.9 | 6.5 | 0.115        |
| FDN-70-L | 11.0 +/- 1.0           | left              | 95 | 82 | 10 | 6.5 | 70 | 65.4 | 1.6 | 13   | 6.5 | 0.135        |

¹ The indicated damping torque refers to a rotational speed of 20 rpm and an ambient temperature of 23 °C.

## FYN-P1

Small diameter, large damping torques

### Partial Rotation Angle

Damping torque 100 Ncm to 180 Ncm

The damping direction of the rotary damper FYN-P1 can be either right or left rotation. The dampers can be directly FYN mounted in the pivot point. During each reverse movement of the unilateral decelerating versions there is a certain return damping torque that depends on the size. Differentiation of the damping direction through the coloured shaft. ACE rotary dampers are maintenance-free and ready-to-install.



### Technical Data

**Construction size:** Ø 18.5 mm

**Lifetime:** 50,000 cycles, even after this time, the dampers still produce over approx. 80 % of their original damping moment. The service life may be significantly higher or lower, depending on the application.

**Operating temperature range:** -5 °C to +50 °C

**Material:** Outer body, Shaft: Plastic

**Mounting:** In any position

**Rotation angle max.:** 115°

**Note:** Damping direction: Right hand damping = damping action in clockwise direction (when looking onto the output shaft or output shaft sleeve, depending on the damper type). A play of approx. 5° can occur at the beginning of movement.

**Mounting information:** No axial or radial forces may be induced via the shaft.

**Safety instructions:** Do not use rotary dampers as supports. Provide an external guide or support.

**On request:** Special designs available on request.

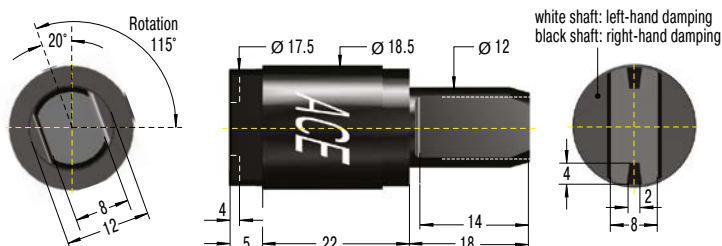

### Performance

| TYPES       | Damping torque | Return Damping Torque | Damping direction | Weight<br>kg |
|-------------|----------------|-----------------------|-------------------|--------------|
|             | Ncm            | Ncm                   |                   |              |
| FYN-P1-R103 | 100            | 30                    | right             | 0.011        |
| FYN-P1-R153 | 150            | 50                    | right             | 0.011        |
| FYN-P1-R183 | 180            | 80                    | right             | 0.011        |
| FYN-P1-L103 | 100            | 30                    | left              | 0.011        |
| FYN-P1-L153 | 150            | 50                    | left              | 0.011        |
| FYN-P1-L183 | 180            | 80                    | left              | 0.011        |

### FYN-N1

Small diameter, large damping torques

#### Partial Rotation Angle

Damping torque 100 Ncm to 300 Ncm

The damping direction of the rotary damper FYN-N1 can be either right or left rotation. The dampers can be directly mounted in the pivot point. During each reverse movement of the unilateral decelerating versions there is a certain return damping torque that depends on the size. Differentiation of the damping direction through coloured end cap. ACE rotary dampers are maintenance-free and ready-to-install.



#### Technical Data

**Construction size:** Ø 20 mm

**Lifetime:** 50,000 cycles, even after this time, the dampers still produce over approx. 80 % of their original damping moment. The service life may be significantly higher or lower, depending on the application.

**Operating temperature range:** -5 °C to +50 °C

**Material:** Outer body, Shaft: Plastic

**Mounting:** In any position

**Rotation angle max.:** 110°

**Note:** Damping direction: Right hand damping = damping action in clockwise direction (when looking onto the output shaft or output shaft sleeve, depending on the damper type). A play of approx. 5° can occur at the beginning of movement.

**Mounting information:** No axial or radial forces may be induced via the shaft.

**Safety instructions:** Do not use rotary dampers as supports. Provide an external guide or support.

**On request:** Special designs available on request.

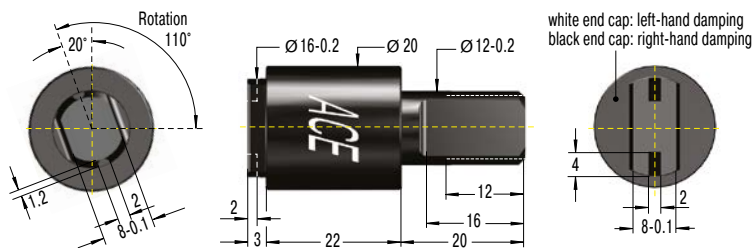

#### Performance

| TYPES       | Damping torque<br>Ncm | Return Damping Torque<br>Ncm | Damping direction | Weight<br>kg |
|-------------|-----------------------|------------------------------|-------------------|--------------|
| FYN-N1-R103 | 100                   | 20                           | right             | 0.012        |
| FYN-N1-R203 | 200                   | 40                           | right             | 0.012        |
| FYN-N1-R253 | 250                   | 40                           | right             | 0.012        |
| FYN-N1-R303 | 300                   | 80                           | right             | 0.012        |
| FYN-N1-L103 | 100                   | 20                           | left              | 0.012        |
| FYN-N1-L203 | 200                   | 40                           | left              | 0.012        |
| FYN-N1-L253 | 250                   | 40                           | left              | 0.012        |
| FYN-N1-L303 | 300                   | 80                           | left              | 0.012        |

## FYN-U1

Small, strong and very robust

### Partial Rotation Angle

Damping torque 200 Ncm to 300 Ncm

The damping direction of the rotary damper FYN-U1 can be either right or left rotation. The dampers can be directly mounted in the pivot point. The body is made of especially robust die-cast zinc. During each reverse movement of the unilateral decelerating versions there is a certain return damping torque that depends on the size. ACE rotary dampers are maintenance-free and ready-to-install.



### Technical Data

**Construction size:** Ø 16 mm

**Lifetime:** 50,000 cycles, even after this time, the dampers still produce over approx. 80 % of their original damping moment. The service life may be significantly higher or lower, depending on the application.

**Operating temperature range:** -5 °C to +50 °C

**Material:** Outer body, Shaft: Zinc die-cast

**Mounting:** In any position

**Rotation angle max.:** 115°

**Note:** Damping direction: Right hand damping = damping action in clockwise direction (when looking onto the output shaft or output shaft sleeve, depending on the damper type). A play of approx. 5° can occur at the beginning of movement.

**Mounting information:** No axial or radial forces may be induced via the shaft.

**Safety instructions:** Do not use rotary dampers as supports. Provide an external guide or support.

**On request:** Special designs available on request.

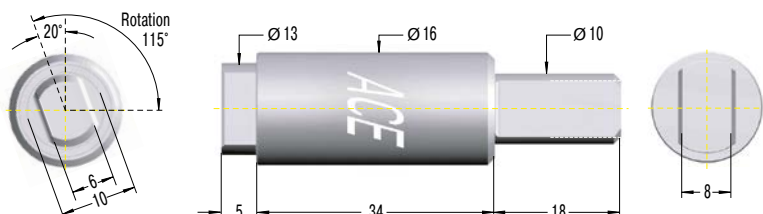

### Performance

| TYPES       | Damping torque | Return Damping Torque | Damping direction | Weight<br>kg |
|-------------|----------------|-----------------------|-------------------|--------------|
|             | Ncm            | Ncm                   |                   |              |
| FYN-U1-R203 | 200            | 40                    | right             | 0.040        |
| FYN-U1-R253 | 250            | 40                    | right             | 0.040        |
| FYN-U1-R303 | 300            | 80                    | right             | 0.040        |
| FYN-U1-L203 | 200            | 40                    | left              | 0.040        |
| FYN-U1-L253 | 250            | 40                    | left              | 0.040        |
| FYN-U1-L303 | 300            | 80                    | left              | 0.040        |

### FYN-S1

The flat damper for constant component protection

**Partial Rotation Angle**

**Damping torque 5 Nm to 10 Nm**

The self-compensating FYN-S1 rotary damper with zinc die-cast body provides a constant sequence of movement for different masses. The damping direction can be either right or left rotation. During each reverse movement of the unilateral decelerating versions there is a certain return damping torque that depends on the size. ACE rotary dampers are maintenance-free and ready-to-install.



### Technical Data

**Construction size:** Ø 60 mm

**Lifetime:** 50,000 cycles, even after this time, the dampers still produce over approx. 80 % of their original damping moment. The service life may be significantly higher or lower, depending on the application.

**Operating temperature range:** -5 °C to +50 °C

**Material:** Outer body: Zinc die-cast; Output shaft sleeve: Plastic

**Mounting:** In any position

**Rotation angle max.:** 130°

**Note:** Damping direction: Right hand damping = damping action in clockwise direction (when looking onto the output shaft or output shaft sleeve, depending on the damper type). A play of approx. 5° can occur at the beginning of movement.

**Mounting information:** No axial or radial forces may be induced via the shaft.

**Safety instructions:** Do not use rotary dampers as supports. Provide an external guide or support.

**On request:** Special designs available on request.

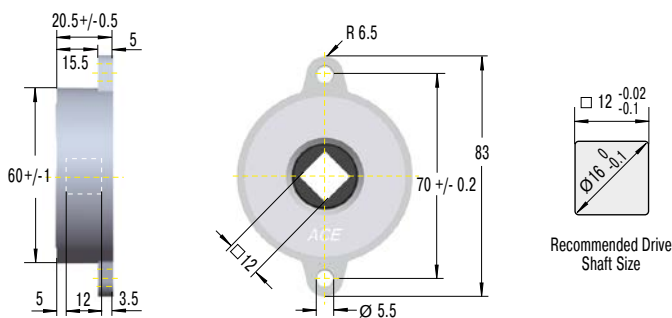

### Performance

| TYPES       | Damping torque<br>Nm | Return Damping Torque<br>Nm | Damping direction | Weight<br>kg |
|-------------|----------------------|-----------------------------|-------------------|--------------|
| FYN-S1-R104 | 5 - 10               | 1.5                         | right             | 0.220        |
| FYN-S1-L104 | 5 - 10               | 1.5                         | left              | 0.220        |

Issue 07.2017 – Specifications subject to change



## FYT-H1 and FYN-H1

Specifically adjustable, strong braking force

**Partial Rotation Angle, Adjustable**  
**Damping torque 2 Nm to 10 Nm**

The damping direction of the adjustable FYT-H1 and FYN-H1 can be right, left or two-sided rotation. During each reverse movement of the unilateral decelerating versions there is a certain return damping torque that depends on the size. The brakes have a particularly robust zinc die-cast body and shafts made of steel. ACE rotary dampers are maintenance-free and ready-to-install.



### Technical Data

**Construction size:** Ø 45 mm

**Lifetime:** 50,000 cycles, even after this time, the dampers still produce over approx. 80 % of their original damping moment. The service life may be significantly higher or lower, depending on the application.

**Operating temperature range:** -5 °C to +50 °C

**Material:** Outer body: Zinc die-cast; Shaft: Steel

**Mounting:** In any position

**Rotation angle max.:** 105°

**Maximum side load:** 50 N

**Note:** Damping direction: Right hand damping = damping action in clockwise direction (when looking onto the output shaft or output shaft sleeve, depending on the damper type). A play of approx. 5° can occur at the beginning of movement.

**Safety instructions:** Do not use rotary dampers as supports. Provide an external guide or support.

**On request:** Special designs available on request.

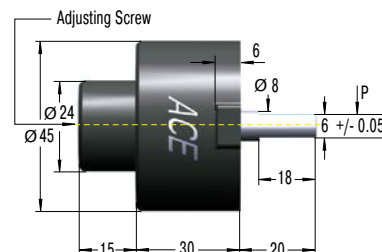
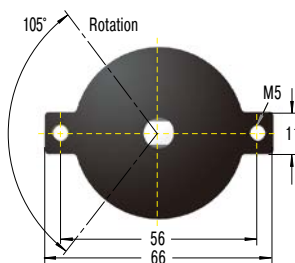

### Performance

| TYPES    | Damping torque<br>Nm | Return Damping Torque<br>Nm | Damping direction | Weight<br>kg |
|----------|----------------------|-----------------------------|-------------------|--------------|
| FYT-H1   | 2 - 10               | 0.5                         | bidirectional     | 0.235        |
| FYN-H1-R | 2 - 10               | 0.5                         | right             | 0.235        |
| FYN-H1-L | 2 - 10               | 0.5                         | left              | 0.235        |

## FYT-LA3 and FYN-LA3

Adjustable high performance

**Partial Rotation Angle, Adjustable  
Damping torque 4 Nm to 40 Nm**

The damping direction of this adjustable high-performance rotary damper can be right, left or two-sided rotation. During each reverse movement of the unilateral decelerating versions there is a certain return damping torque that depends on the size. The brakes have a particularly robust zinc die-cast body and shafts made of steel. ACE rotary dampers are maintenance-free and ready-to-install.



### Technical Data

**Construction size:** Ø 80 mm

**Lifetime:** 50,000 cycles, even after this time, the dampers still produce over approx. 80 % of their original damping moment. The service life may be significantly higher or lower, depending on the application.

**Operating temperature range:** -5 °C to +50 °C

**Material:** Outer body: Zinc die-cast; Shaft: Steel

**Mounting:** In any position

**Rotation angle max.:** 210°

**Maximum side load:** 200 N

**Note:** Damping direction: Right hand damping = damping action in clockwise direction (when looking onto the output shaft or output shaft sleeve, depending on the damper type). A play of approx. 5° can occur at the beginning of movement.

**Safety instructions:** Do not use rotary dampers as supports. Provide an external guide or support.

**On request:** Special designs available on request.

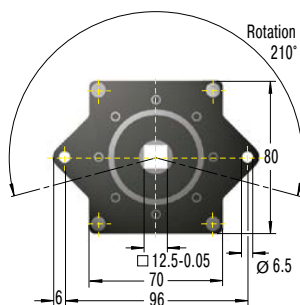

Keyed output shaft shown in mid-travel position

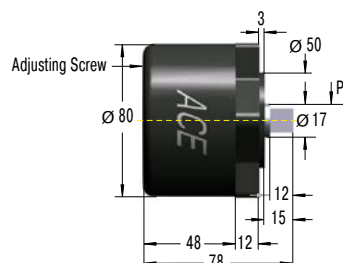

### Performance

| TYPES     | Damping torque<br>Nm | Return Damping Torque<br>Nm | Damping direction | Weight<br>kg |
|-----------|----------------------|-----------------------------|-------------------|--------------|
| FYT-LA3   | 4 - 40               | 4                           | bidirectional     | 1.720        |
| FYN-LA3-R | 4 - 40               | 4                           | right             | 1.725        |
| FYN-LA3-L | 4 - 40               | 4                           | left              | 1.725        |

### Calculation Example

#### Damping of a Lid

To select an appropriate rotary damper for the adjacent calculation example, the length and the weight or the centre of gravity of the flap have to be known. After determining the value of the max. torque at an unfavourable angle of the flap, select the appropriate damper.

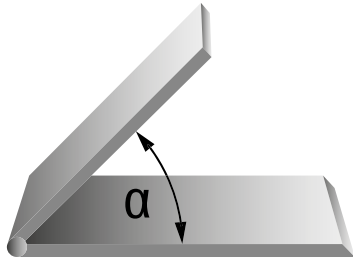

#### Calculation Steps

1. Calculate max. torque damper will be exposed to (with example shown on the left max. torque is at  $\alpha = 0^\circ$ ).
2. Decide upon rotation speed desired.
3. Choose a rotary damper that can handle the torque calculated above.
4. With the aid of the damper performance curves, check if the r.p.m. given at your torque corresponds to the desired closing speed of the lid.
5. If the r.p.m. is too high – choose a damper with a higher torque rating.  
If the r.p.m. is too low – choose a damper with a lower torque rating.

Closing Torque  
 $M = L / 2 \cdot m \cdot g \cdot \cos \alpha$   
 (L / 2 = centre of gravity)

**m** Mass of a lid [kg] (1 kg = 9.81 N)  
**L** Length of lid from pivot [cm]  
**n** Rotation speed [r.p.m.]

### Special Accessories

#### Toothed Racks for Rotary Dampers with Gear

Rotary dampers with gears are available in four standard modules which can be optionally supplied with plastic toothed racks as accessories.

**M0.5, M0.6, M0.8, M1.0**  
Toothed Rack

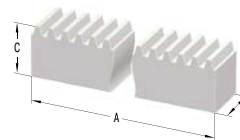

**M0.8P**  
Toothed Rack

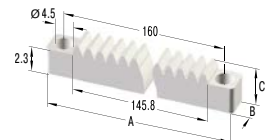

#### Delivery Notes

**Delivery form:** Toothed plastic racks with modules 0.5 to 1.0 availables ex stock

**On request:** Toothed metal racks

#### Dimensions

| TYPES | A<br>mm | B<br>mm | C<br>mm | Model            |
|-------|---------|---------|---------|------------------|
| M0.5  | 250     | 4       | 4.5     | rigid, milled    |
| M0.6  | 250     | 4       | 6       | rigid, milled    |
| M0.8  | 250     | 6       | 8       | rigid, milled    |
| M0.8P | 170     | 8       | 4.1     | flexible, milled |
| M1.0  | 250     | 9       | 9       | rigid, milled    |
| M1.0  | 500     | 10      | 10      | rigid, milled    |

### Mounting Information

The rotary axis, square receptacles or free-wheel receptacles are not designed for lateral loads. An external guide or bearing support is fundamentally recommended.

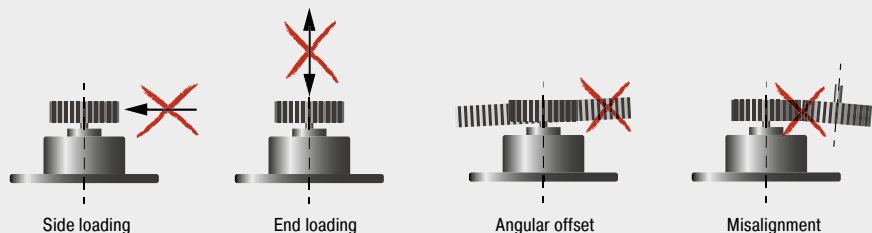

## Application Examples

### FDT

#### Finger protection when cutting bread

To exclude the possibility of injury when using bread slicing machines on self-service counters, the automatic bread slicing process does not start until the flap of the modern machine is closed. To simplify the operation and to thereby increase acceptance of the self-slicing principle among users, two-way rotary dampers of the type FDT-57 ensure smooth opening and closing of the door. Even when rotary dampers must act only in one direction, ACE has appropriate variants readily available.



Protective flaps secured with rotary dampers: the simple operation of bread slicing machines can then be easily managed by hand  
Daub Bakery Machinery BV, 5050 AB Goirle, Netherlands

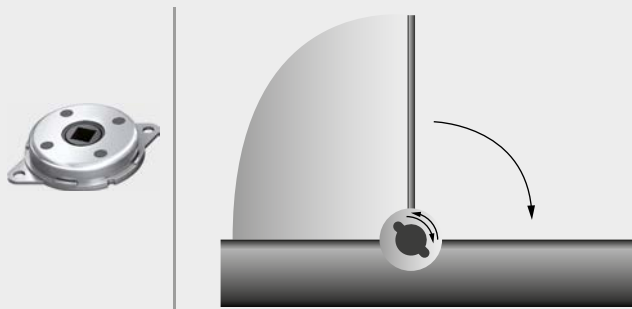

### FDN-R

#### Invisible protection for cooker hoods

For ergonomic handling, modern cooker hoods can be driven by a motor into an up position and then down again. When driven downwards, an AC load can result in a total loss through current being fed back into the voltage source. One of the tasks of the ACE rotary dampers type FDN-63-R is to prevent this. The modern machine elements are also built to provide protection against motor failure. Sliding the hood down too quickly could lead to further costly damage to the hood and the ceiling console and even cause personal injury.



Rotary dampers in high-end cooker hoods safeguard the protection of drive units and protect chefs, even during power failures  
berbel Ablufttechnik GmbH, 48432 Rheine, Germany



# Vibration Control

**Vibration-Isolating Pads  
Rubber-Metal Isolators  
Low Frequency Pneumatic Levelling Mounts**



# Isolate Unwanted Vibrations Effectively

## Unique variety

**This product group from ACE includes innovative solutions to provide customers with the best assistance in insulation technology and vibration isolation. These machine elements are also distinguished by their light design and exemplary variety.**

The product range extends from extremely low frequency isolating pneumatic levelling mounts through to ready-to-install rubber-metal isolators and insulation plates. With this portfolio, ACE is capable of offering you customised vibration isolation and all almost any applications.

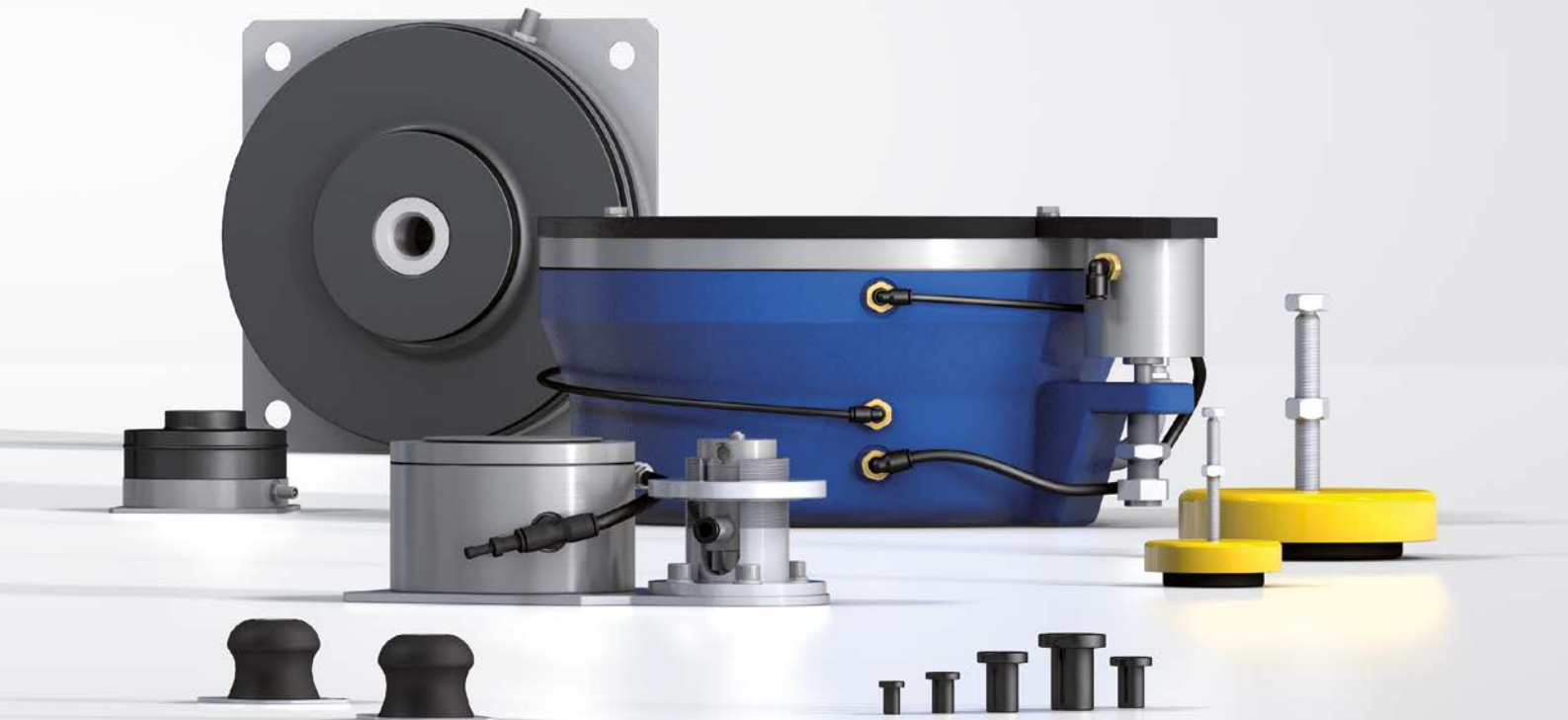



# Vibration Isolation

**Noise reduction and vibration isolation are becoming more and more important in our daily lives. This applies in particular to the workplace and the environments around production companies.**

Preventing noise emissions or harmful vibrations is therefore not only a necessity required by noise protection and occupational health and safety legislation; their sources must also be localised by means of targeted analyses in order to develop suitable improvement measures for achieving, for example, increased production quality. A second by-product of vibrations are their effects on the surrounding production environment and any measuring and testing facilities that may be in use.

## Advantages and function

- improved working conditions for people and the environment
- more accurate production tolerances and thereby increased product quality
- competitive and cost advantages thanks to lower reject rate in production
- increased production speed thanks to increased maximum machine dynamics
- longer tool and machine life thanks to lower stress
- faster and more accurate measuring results

For detailed information see special catalogue "ACEolator"



# Rubber-Metal Isolators

## Ready-to-install isolators for quick selection

Rubber-metal isolators and machine feet are supplied ready-to-install and are used in a large variety of vibration isolation applications. Common applications are engines, compressors, transfer systems, machines, fans and blowers.



### LEV

#### Levelling Mounts (height-adjustable machine feet)

Secure, adjustable stabilisation for all types of machines, transfer systems, assembly stations, etc.



### CM

#### Cup Mounts (cup elements)

For isolating machinery and equipment. Fail-safe isolators for all axes in any installation position. Application examples: compressors, off-road vehicles, engines, fans, etc.



### COM

#### Compression Mounts (pre-tensioned high-performance bearing surface)

Vertically acting isolators for machinery and equipment. Applications include: blowers, compressors, motors, generators, presses, etc.



### AAM

#### All Attitude Mounts (vibration-isolating fasteners)

Maintenance free isolators for decoupling parts and components in electronics, aerospace, the military, medicine, transfer systems, etc.



### SFM

#### Stable Flex Mounts (stable machine feet)

Extremely rugged and maintenance-free isolators, e.g. for marine applications, for diesel generators, in power generation or in off-road vehicles.



### BM

#### Bubble Mounts (low-frequency vibration isolators)

For protecting small devices and electronic components, e.g. in medical technology, aerospace, electronic systems or computers.



### UMO

#### Universal Mounts (universal connection isolators)

Maintenance-free connection isolators which can be implemented both radially and axially. Application examples: conveying systems, machinery and equipment, off-road, oil and gas industry, control systems, etc.



### FL

#### Flex Locs (quick fastening elements)

Simple, efficient components with versatile applications as isolating fasteners for decoupling structure-borne sound in enclosures, housings, equipment and machinery. For application in mechanical engineering, in buildings, vehicles, or navigation.

# Vibration-Isolating Pads

## Customised insulation technology through cutting and combining

A wide range of applications such as e.g. machine foundations, supports, decoupling elements, pipelines and subsequently protected machines require tailor-made solutions. Here with its product range of vibration insulating pads ACE offers comprehensive possibilities for insulation. The products are manufactured and supplied either as standard pads or as drawing parts according to customer request.



### SLAB

#### Universal Damping Pads

For application on foundations for plants and machines, compressors, in pump stations, generators, for insulations, measuring tables, buildings, etc.



### CEL

#### Low-Frequency Damping Pads

For use in foundations, buildings, transport routes, bridges, stairs, test benches, pump stations, generators, compressors, machines, etc.



### PAD

#### Rugged Fibre and Elastomer Pads

For isolating and protecting foundations, e.g. of presses, plants, machines, as well as for use in pump stations, crane runways, bridges and heavy-duty applications

## Application overview

| Type                            | Machines | Transfer systems | Construction Transport | Blower Fan | Foundations | Control units Electrical systems | Off-road vehicles |
|---------------------------------|----------|------------------|------------------------|------------|-------------|----------------------------------|-------------------|
| <b>Rubber-Metal Isolators</b>   |          |                  |                        |            |             |                                  |                   |
| LEV                             | ■        | ■                |                        | ■          |             |                                  |                   |
| CM                              | ■        |                  | ■                      | ■          |             |                                  | ■                 |
| COM                             | ■        | ■                |                        | ■          |             | ■                                |                   |
| AAM                             |          | ■                | ■                      |            |             | ■                                | ■                 |
| SFM                             |          |                  | ■                      |            |             |                                  | ■                 |
| BM                              |          |                  |                        | ■          |             | ■                                |                   |
| UMO                             | ■        | ■                | ■                      |            |             | ■                                | ■                 |
| FL                              | ■        |                  | ■                      |            |             | ■                                |                   |
| <b>Vibration-Isolating Pads</b> |          |                  |                        |            |             |                                  |                   |
| SLAB                            | ■        | ■                | ■                      | ■          | ■           |                                  |                   |
| CEL                             | ■        | ■                | ■                      | ■          | ■           |                                  |                   |
| PAD                             | ■        |                  | ■                      |            | ■           |                                  | ■                 |
| <b>Air Spring Elements</b>      |          |                  |                        |            |             |                                  |                   |
| PLM                             | ■        |                  |                        |            |             |                                  |                   |
| PAL                             |          |                  |                        |            | ■           |                                  |                   |

Issue 07.2017 – Specifications subject to change

# Low Frequency Pneumatic Levelling Mounts

**Highly efficient insulation – it can hardly get any deeper**

Everywhere where perfect isolation of measuring tables, test equipment and high-performance machines are important the low frequency pneumatic levelling mounts PLM and PAL are a good choice. On request a detailed system analysis will be carried out at the customer and the perfect solution will be developed.



## PLM

### Pneumatic Air Spring Elements

For an efficient isolation of measuring equipment, high-speed presses and machines.



## PAL-3 to PAL-9

### Small Size Air Spring Elements

The perfect levelling and isolation system for smaller constructions that require precision and flexibility. Available in the system with many accessories.



## PAL-18 to PAL-1000

### Big Air Spring Elements with Automatic Level Controls

Isolation against disruptive vibrations and level-adjustment for test and measuring equipment. Isolating at extremely low-frequencies, these components are used in the automotive industry and in aerospace engineering.

More information about Vibration Control can be found in our special catalog and on our Website [www.ace-ace.com / Downloads](http://www.ace-ace.com/Downloads)

Issue 07.2017 – Specifications subject to change

| Engines<br>Generators           | Compressors | Oil and<br>gas industry | Aerospace<br>engineering | Presses | Medicine | Measuring<br>tables | Test<br>benches | Type |
|---------------------------------|-------------|-------------------------|--------------------------|---------|----------|---------------------|-----------------|------|
| <b>Rubber-Metal Isolators</b>   |             |                         |                          |         |          |                     |                 |      |
|                                 |             |                         |                          | ■       |          |                     |                 | LEV  |
| ■                               | ■           | ■                       | ■                        |         |          |                     |                 | CM   |
| ■                               | ■           |                         |                          | ■       |          |                     |                 | COM  |
| ■                               |             |                         | ■                        |         | ■        |                     |                 | AAM  |
| ■                               | ■           |                         |                          |         |          |                     |                 | SFM  |
|                                 |             |                         |                          |         | ■        |                     |                 | BM   |
| ■                               | ■           | ■                       | ■                        |         |          |                     |                 | UMO  |
| ■                               | ■           |                         |                          |         |          |                     |                 | FL   |
| <b>Vibration-Isolating Pads</b> |             |                         |                          |         |          |                     |                 |      |
|                                 |             | ■                       |                          | ■       | ■        | ■                   |                 | SLAB |
|                                 |             | ■                       |                          | ■       | ■        | ■                   | ■               | CEL  |
|                                 |             | ■                       |                          | ■       |          |                     |                 | PAD  |
| <b>Air Spring Elements</b>      |             |                         |                          |         |          |                     |                 |      |
|                                 |             |                         |                          | ■       | ■        | ■                   | ■               | PLM  |
|                                 |             |                         | ■                        |         |          | ■                   | ■               | PAL  |

# Safety Products

**Safety Shock Absorbers, Safety Dampers  
Clamping Elements**



# Highest Protection under any Circumstances

For any budget and all requirements

**Safely slowing down damaging forces from moving loads or  
Emergency braking are united in this product group from ACE.  
Although the safety shock absorbers, profile dampers and  
clamping elements differ so much in design, every single ACE  
component provides the best protection for your machine.**

They demonstrate their main advantages in emergency stop situations  
and, based on the protection they provide, are very cost-effective.  
Furthermore, they can all be easily integrated in the existing construction  
designs and largely work independent of energy supplies.





# Safety Shock Absorbers

## Perfect protection for the worst case scenario

**As a cheaper alternative to the standard shock absorber, Safety shock absorbers are the tried and tested low cost method of preventing those occasional emergency stops. Designed for occasional use, they primarily serve as reliable, effective protection in emergency stopping for construction designs.**

The maintenance-free and ready-to-install machine elements are characterised in every respect by the well-known high ACE quality and maximum energy absorption of up to 480,000 Nm/Cycle. This means, in the product family SCS33 up to SCS64 a service life of up to 1,000 full load emergency cycles is achieved. Safety shock absorbers from ACE are available in a large choice with strokes of 23 mm to 1,200 mm, and the arrangement of orifice pattern can be calculated and produced specifically to the customer's requirements and depending on the application.



## Safety Shock Absorbers



### SCS33 to SCS64

Page 250

Self-Compensating or Optimized Characteristic

**Industry design with high energy absorption**

Finishing and processing centres, Conveyor systems, Portal systems, Test stations



### SDH38 to SDH63

Page 254

High Rack Damper, Optimized Characteristic

**Low reaction forces with long strokes**

Shelf storage systems, Test stations, Heavy load applications, Conveyor systems



### SDP63 to SDP160

Page 258

Crane Installations, Optimized Characteristic

**High return forces with gas pressure accumulator**

Shelf storage systems, Heavy load applications

Top machine protection

Latest damping technology

Attractive cost-benefit ratio

Maximum traverses

Wide application spectrum

Robust design



## SCS33 to SCS64

Industry design with high energy absorption

**Self-Compensating or Optimized Characteristic**  
**Energy capacity 310 Nm/Cycle to 18,000 Nm/Cycle**  
**Stroke 23.1 mm to 150 mm**

Effective emergency stop: The ACE safety shock absorbers from the SCS33 to SCS64 product family are based on the innovative technology of the successful industrial shock absorbers from the MAGNUM-Series. They are also maintenance-free and ready-to-install.

Due to the optimised characteristic curve for the respective application, the energy absorption of these hydraulic machine elements can be increased to more than twice the level of the MAGNUM model of ACE industrial shock absorber per stroke. Users benefit from a service life of up to 1,000 full load emergency cycles with a very good price-performance ratio. Their compact design in sizes M33x1.5 to M64x2 makes them easy to integrate into current applications.

These slimline, high-performance safety shock absorbers are only designed for emergency stop situations. They can be used for a number of tasks in gantries and conveyor systems, processing centres or assembly machines.

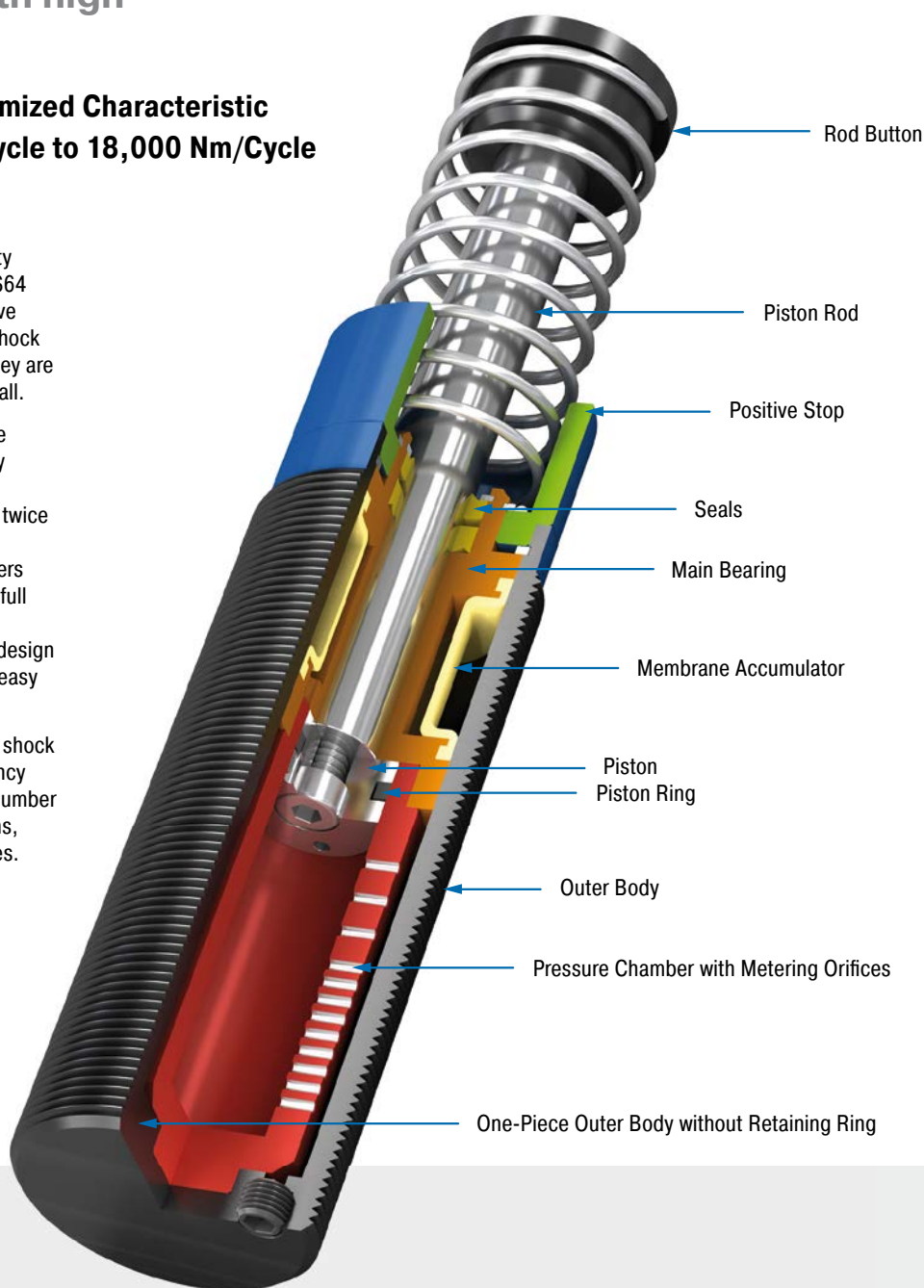

### Technical Data

**Energy capacity:** 310 Nm/Cycle to 18,000 Nm/Cycle

**Impact velocity range:** 0.02 m/s to 5 m/s. Other speeds on request.

**Operating temperature range:** -12 °C to +66 °C. Other temperatures on request.

**Mounting:** In any position

**Positive stop:** Integrated

**Material:** Outer body: Nitride hardened steel; Piston rod: Hard chrome plated steel; Rod end button: Hardened steel and corrosion-resistant coating; Return spring: Zinc plated or plastic-coated steel; Accessories: Steel corrosion-resistant coating

**Damping medium:** Automatic Transmission Fluid (ATF)

**Application field:** Finishing and processing centres, Conveyor systems, Portal systems, Test stations, Machines and plants, Swivel units, Cranes

**Note:** The shock absorber can be pushed through its stroke. In creep speed conditions the shock absorber provides minimal resistance and there is no braking effect.

**On request:** Special oils, special flanges etc.

### SCS33EU

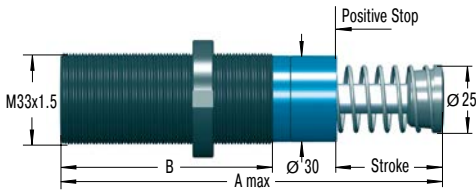

The calculation and selection of the most suitable damper should be carried out or be approved by ACE.

### Accessories

#### NM33

Locking Ring

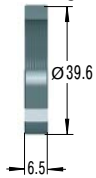

#### QF33

Square Flange

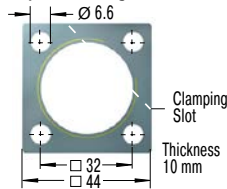

Torque max.: 11 Nm  
Clamping torque: > 90 Nm  
Install with 4 machine screws

#### S33

Side Foot Mounting Kit

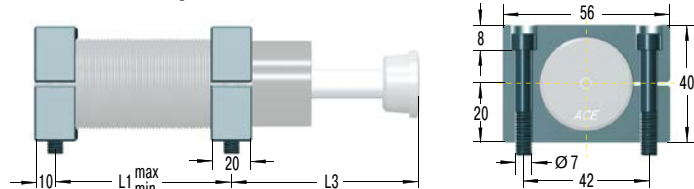

S33 = 2 flanges + 4 screws M6x40, DIN 912

Torque max.: 11 Nm

Clamping torque: 90 Nm

Because of the thread pitch the fixing holes for the second foot mount should only be drilled and tapped after the first foot mount has been fixed in position.

### Complete details required when ordering

- Moving load: m (kg)
- Impact velocity range: v (m/s) max.
- Creep speed: vs (m/s)
- Motor power: P (kW)
- Stall torque factor: ST (normal, 2.5)
- (Alternatively: Propelling force F (N))
- Number of absorbers in parallel: n

or technical data according to formulae and calculations on page 265.

### Ordering Example

**SCS33-50EU-1xxxx**

Safety Shock Absorber \_\_\_\_\_

Thread Size M33 \_\_\_\_\_

Max. Stroke without Positive Stop 50 mm \_\_\_\_\_

EU Compliant \_\_\_\_\_

Identification No. assigned by ACE \_\_\_\_\_

**Please indicate identification no. in case of replacement order**

### Performance and Dimensions

| TYPES      | Max. Energy Capacity                      |                                   | Return Force min. N | Return Force max. N | Stroke mm | A max. mm | B mm | L1 min. mm | L1 max. mm | L3 mm | Side Load Angle max. ° | Weight kg |
|------------|---|-----------------------------------|---------------------|---------------------|-----------|-----------|------|------------|------------|-------|------------------------|-----------|
|            | W <sub>3</sub> Self-compensating Nm/cycle | W <sub>3</sub> Optimised Nm/cycle |                     |                     |           |           |      |            |            |       |                        |           |
| SCS33-25EU | 310                                       | 500                               | 45                  | 90                  | 23.2      | 138       | 83   | 25         | 60         | 68    | 3                      | 0.51      |
| SCS33-50EU | 620                                       | 950                               | 45                  | 135                 | 48.6      | 189       | 108  | 32         | 86         | 93    | 2                      | 0.63      |

<sup>1</sup> The values are reduced by 20 % at max. side load angle.

**SCS45EU**

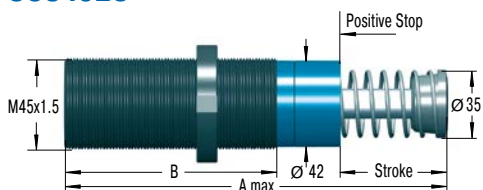

The calculation and selection of the most suitable damper should be carried out or be approved by ACE.

**Accessories**

**NM45**

Locking Ring

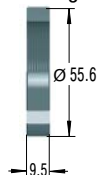

**QF45**

Square Flange

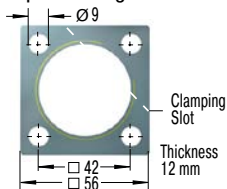

Torque max.: 27 Nm  
Clamping torque: > 200 Nm  
Install with 4 machine screws

**S45**

Side Foot Mounting Kit

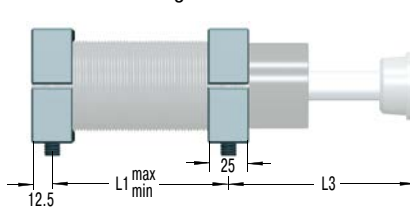

S45 = 2 flanges + 4 screws M8x50, DIN 912  
Torque max.: 27 Nm  
Clamping torque: 350 Nm  
Because of the thread pitch the fixing holes for the second foot mount should only be drilled and tapped after the first foot mount has been fixed in position.

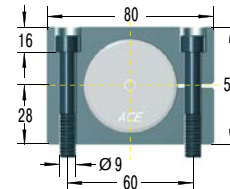

**Complete details required when ordering**

- Moving load: m (kg)
- Impact velocity range: v (m/s) max.
- Creep speed: vs (m/s)
- Motor power: P (kW)
- Stall torque factor: ST (normal, 2.5)
- (Alternatively: Propelling force F (N))
- Number of absorbers in parallel: n

or technical data according to formulae and calculations on page 265.

**Ordering Example**

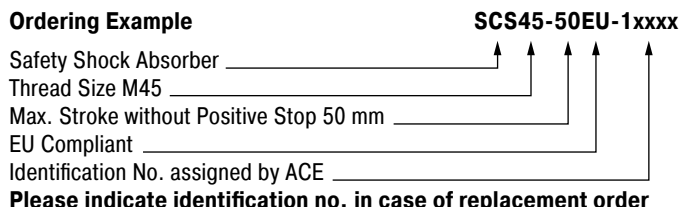

**Please indicate identification no. in case of replacement order**

**Performance and Dimensions**

| TYPES      | Max. Energy Capacity                      |                                   | Return Force min. N | Return Force max. N | Stroke mm | A max. mm | B mm | L1 min. mm | L1 max. mm | L3 mm | Side Load Angle max. ° | Weight kg |
|------------|---|-----------------------------------|---------------------|---------------------|-----------|-----------|------|------------|------------|-------|------------------------|-----------|
|            | W <sub>3</sub> Self-compensating Nm/cycle | W <sub>3</sub> Optimised Nm/cycle |                     |                     |           |           |      |            |            |       |                        |           |
| SCS45-25EU | 680                                       | 1,200                             | 70                  | 100                 | 23.1      | 145       | 95   | 32         | 66         | 66    | 3                      | 1.13      |
| SCS45-50EU | 1,360                                     | 2,350                             | 70                  | 145                 | 48.5      | 195       | 120  | 40         | 92         | 91    | 2                      | 1.36      |
| SCS45-75EU | 2,040                                     | 3,500                             | 50                  | 180                 | 73.9      | 246       | 145  | 50         | 118        | 116   | 1                      | 1.59      |

<sup>1</sup> The values are reduced by 20 % at max. side load angle.

### SCS64EU

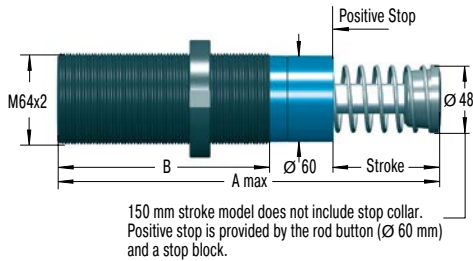

The calculation and selection of the most suitable damper should be carried out or be approved by ACE.

### Accessories

#### NM64

Locking Ring

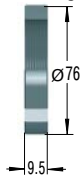

#### QF64

Square Flange

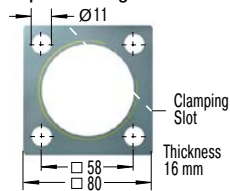

Torque max.: 50 Nm  
Clamping torque: > 210 Nm  
Install with 4 machine screws

#### S64

Side Foot Mounting Kit

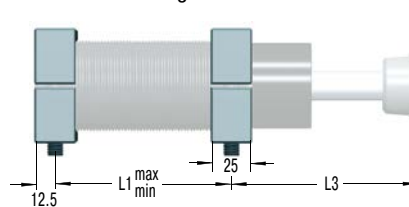

S64 = 2 flanges + 4 screws M10x80, DIN 912

Torque max.: 50 Nm

Clamping torque: 350 Nm

Because of the thread pitch the fixing holes for the second foot mount should only be drilled and tapped after the first foot mount has been fixed in position.

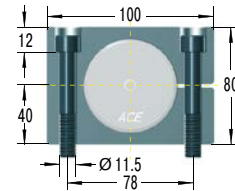

### Complete details required when ordering

Moving load: m (kg)  
Impact velocity range: v (m/s) max.  
Creep speed: vs (m/s)  
Motor power: P (kW)  
Stall torque factor: ST (normal, 2.5)  
(Alternatively: Propelling force F (N))  
Number of absorbers in parallel: n

or technical data according to formulae and calculations on page 265.

### Ordering Example

SCS64-50EU-1xxxx  
Safety Shock Absorber \_\_\_\_\_  
Thread Size M64 \_\_\_\_\_  
Max. Stroke without Positive Stop 50 mm \_\_\_\_\_  
EU Compliant \_\_\_\_\_  
Identification No. assigned by ACE \_\_\_\_\_

Please indicate identification no. in case of replacement order

### Performance and Dimensions

| TYPES       | Max. Energy Capacity                         |                                      | Return Force<br>min.<br>N | Return Force<br>max.<br>N | Stroke<br>mm | A max.<br>mm | B<br>mm | L1 min.<br>mm | L1 max.<br>mm | L3<br>mm | Side Load<br>Angle max.<br>° | Weight<br>kg |
|-------------|--|--------------------------------------|---------------------------|---------------------------|--------------|--------------|---------|---------------|---------------|----------|------------------------------|--------------|
|             | W <sub>3</sub> Self-compensating<br>Nm/cycle | W <sub>3</sub> Optimised<br>Nm/cycle |                           |                           |              |              |         |               |               |          |                              |              |
| SCS64-50EU  | 3,400  | 6,000                                | 90                        | 155                       | 48.6         | 225          | 140     | 50            | 112           | 100      | 3                            | 2.90         |
| SCS64-100EU | 6,800  | 12,000                               | 105                       | 270                       | 99.4         | 326          | 191     | 64            | 162           | 152      | 2                            | 3.70         |
| SCS64-150EU | 10,200                                       | 18,000                               | 75                        | 365                       | 150.0        | 450          | 241     | 80            | 212           | 226      | 1                            | 5.10         |

<sup>1</sup> The values are reduced by 20 % at max. side load angle.



## SDH38 to SDH63

Low reaction forces with long strokes

**High Rack Damper, Optimized Characteristic**  
**Energy capacity 3,600 Nm/Cycle to 229,100 Nm/Cycle**  
**Stroke 100 mm to 800 mm**

Intelligent protective measure: The safety shock absorbers from the SDH38 to SDH63 series are also designed for emergency-stop applications. Strokes of up to 1,200 mm are possible with these maintenance-free and ready-to-install dampers. Low support forces result due to the large strokes.

The characteristic curve or damping characteristics of all safety shock absorbers from ACE is individually adjusted to the respective application, specific to the customer. The metering orifices for the respective application are specially calculated and produced. These tailor-made machine elements are the ideal protection because they are less expensive than industrial shock absorbers and are effective with up to 1,000 maximum full load emergency cycles possible.

Anyone who wants to reliably protect the end positions of rack operating equipment, conveyor and crane systems, heavy duty applications and test benches chooses these safety shock absorbers from ACE.

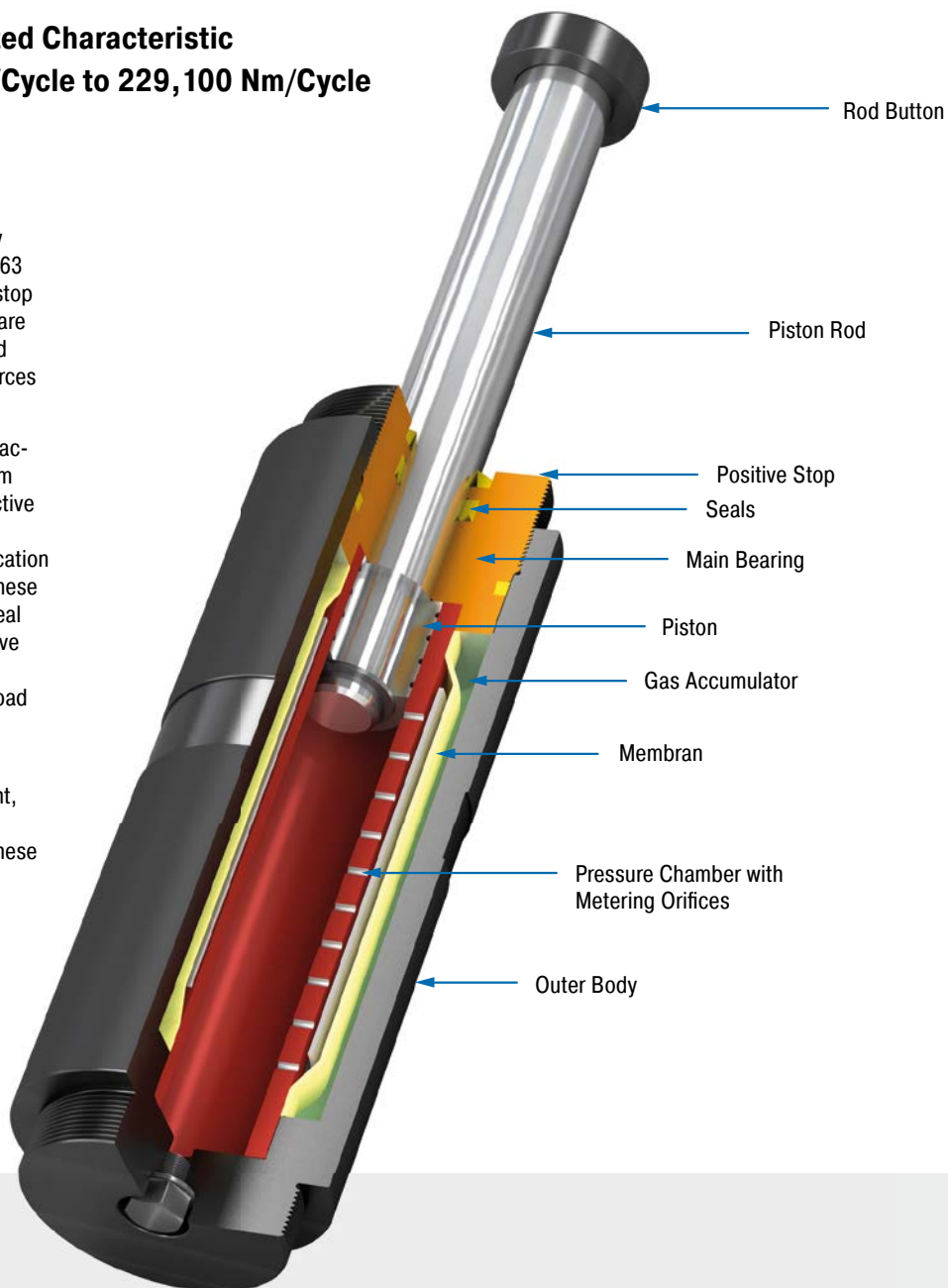

### Technical Data

**Energy capacity:** 3,600 Nm/Cycle to 229,100 Nm/Cycle

**Impact velocity range:** 0.5 m/s to 4.6 m/s. Other speeds on request.

**Reacting force:** At max. capacity rating = 51 kN to 210 kN

**Operating temperature range:** -20 °C to +60 °C. Other temperatures on request.

**Mounting:** In any position

**Positive stop:** Integrated

**Material:** Outer body: Painted steel; Piston rod: Hard chrome plated steel; Rod end button: Steel

**Damping medium:** HLP 46

**Filling pressure:** Approx. 5 bar. Rod return by integrated nitrogen accumulator.

**Application field:** Shelf storage systems, Test stations, Heavy load applications, Conveyor systems, Portal systems

**Note:** For creep speed applications, please consult ACE.

**On request:** Special oils, special flanges, additional corrosion protection etc. Integrated rod sensor for indicating the complete extension of the piston rod. Type normally closed or normally open, option PNP or NPN switch.

### SDH38EU-F Front Flange

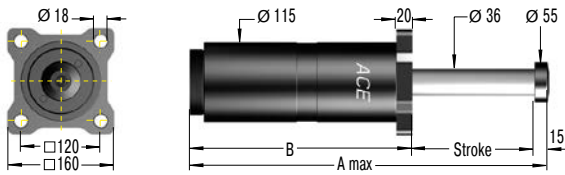

### SDH38EU-R Rear Flange

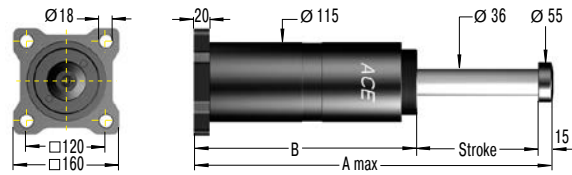

### SDH38EU-S Foot Mount

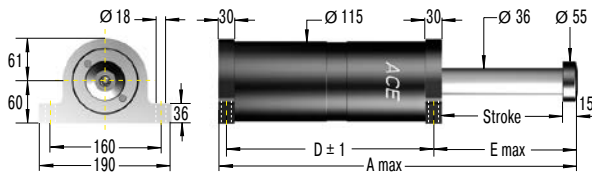

## Technical Data

**Impact velocity range:** 0.9 m/s to 4.6 m/s

### Complete details required when ordering

- Moving load: m (kg)
- Impact velocity range: v (m/s) max.
- Creep speed: vs (m/s)
- Motor power: P (kW)
- Stall torque factor: ST (normal, 2.5)
- (Alternatively: Propelling force F (N))
- Number of absorbers in parallel: n

or technical data according to formulae and calculations on page 265.

**The calculation and selection of the most suitable damper should be carried out or be approved by ACE.**

### Ordering Example

**SDH38-400EU-F-XXXX**

Safety Shock Absorber \_\_\_\_\_

Bore Size Ø 38 mm \_\_\_\_\_

Stroke 400 mm \_\_\_\_\_

EU Compliant \_\_\_\_\_

Mounting Style: Front Flange \_\_\_\_\_

Identification No. assigned by ACE \_\_\_\_\_

**Please indicate identification no. in case of replacement order**

## Performance and Dimensions

| TYPES       | ¹ Energy capacity<br>Nm/cycle | ¹ Reacting Force<br>N | Return Force |           | Stroke<br>mm | A max.<br>mm | B<br>mm | D<br>mm | E max.<br>mm | Mounting Style          |                   |
|-------------|-------------------------------|-----------------------|--------------|-----------|--------------|--------------|---------|---------|--------------|-------------------------|-------------------|
|             |                               |                       | min.<br>N    | max.<br>N |              |              |         |         |              | F and R<br>Weight<br>kg | S<br>Weight<br>kg |
| SDH38-50EU  | 3,600                         | 80,000                | 600          | 700       | 50           | 270          | 204     | 165     | 84           | 14.0                    | 13.7              |
| SDH38-100EU | 7,300                         | 80,000                | 600          | 700       | 100          | 370          | 254     | 215     | 134          | 15.5                    | 15.7              |
| SDH38-150EU | 10,900                        | 80,000                | 600          | 700       | 150          | 470          | 304     | 265     | 184          | 17.0                    | 17.2              |
| SDH38-200EU | 14,500                        | 80,000                | 600          | 700       | 200          | 585          | 369     | 330     | 234          | 20.0                    | 19.7              |
| SDH38-250EU | 18,200                        | 80,000                | 600          | 700       | 250          | 685          | 419     | 380     | 284          | 22.0                    | 21.7              |
| SDH38-300EU | 21,800                        | 80,000                | 600          | 700       | 300          | 800          | 484     | 445     | 334          | 24.0                    | 23.7              |
| SDH38-350EU | 25,500                        | 80,000                | 600          | 700       | 350          | 900          | 534     | 495     | 384          | 26.0                    | 25.7              |
| SDH38-400EU | 29,100                        | 80,000                | 600          | 700       | 400          | 1,015        | 599     | 560     | 434          | 28.0                    | 28.2              |
| SDH38-500EU | 36,400                        | 80,000                | 600          | 700       | 500          | 1,230        | 714     | 675     | 534          | 32.0                    | 32.2              |
| SDH38-600EU | 43,600                        | 80,000                | 600          | 700       | 600          | 1,445        | 829     | 790     | 634          | 36.0                    | 36.2              |
| SDH38-700EU | 50,900                        | 80,000                | 600          | 700       | 700          | 1,660        | 944     | 905     | 734          | 40.0                    | 40.2              |
| SDH38-800EU | 58,200                        | 80,000                | 600          | 700       | 800          | 1,875        | 1,059   | 1,020   | 834          | 44.0                    | 44.2              |

¹ The values apply to mounting style Front Flange and Foot Mounting. For mounting style Rear Flange, please consult ACE.  
In case of an existing side load angle, please consult ACE.

**SDH50EU-F Front Flange**

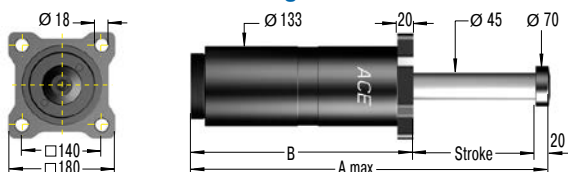

**SDH50EU-R Rear Flange**

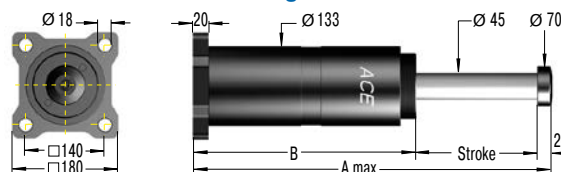

**SDH50EU-S Foot Mount**

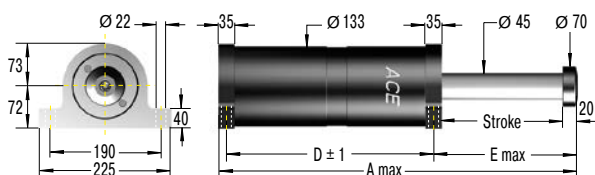

**Technical Data**

Impact velocity range: 0.6 m/s to 4.6 m/s

**Complete details required when ordering**

- Moving load: m (kg)
- Impact velocity range: v (m/s) max.
- Creep speed: vs (m/s)
- Motor power: P (kW)
- Stall torque factor: ST (normal, 2.5)
- (Alternatively: Propelling force F (N))
- Number of absorbers in parallel: n

or technical data according to formulae and calculations on page 265.

The calculation and selection of the most suitable damper should be carried out or be approved by ACE.

**Ordering Example**

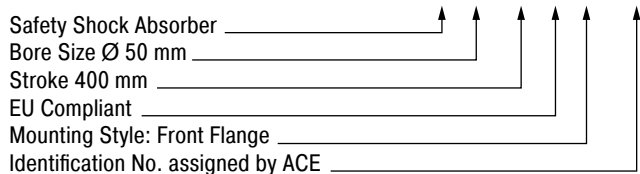

**Please indicate identification no. in case of replacement order**

**Performance and Dimensions**

| TYPES        | 1 Energy capacity<br>Nm/cycle | 1 Reacting Force<br>N | Return Force |           | Stroke<br>mm | A max.<br>mm | B<br>mm | D<br>mm | E max.<br>mm | Mounting Style          |                   |
|--------------|-------------------------------|-----------------------|--------------|-----------|--------------|--------------|---------|---------|--------------|-------------------------|-------------------|
|              |                               |                       | min.<br>N    | max.<br>N |              |              |         |         |              | F and R<br>Weight<br>kg | S<br>Weight<br>kg |
| SDH50-100EU  | 14,500                        | 160,000               | 1,000        | 1,200     | 100          | 416          | 297     | 258     | 139          | 23.5                    | 25.0              |
| SDH50-150EU  | 21,800                        | 160,000               | 1,000        | 1,200     | 150          | 516          | 347     | 308     | 189          | 26.0                    | 27.5              |
| SDH50-200EU  | 29,100                        | 160,000               | 1,000        | 1,200     | 200          | 616          | 397     | 358     | 239          | 28.5                    | 30.0              |
| SDH50-250EU  | 36,400                        | 160,000               | 1,000        | 1,200     | 250          | 731          | 462     | 423     | 289          | 32.0                    | 33.5              |
| SDH50-300EU  | 43,600                        | 160,000               | 1,000        | 1,200     | 300          | 831          | 512     | 473     | 339          | 34.5                    | 36.0              |
| SDH50-350EU  | 50,900                        | 160,000               | 1,000        | 1,200     | 350          | 931          | 562     | 523     | 389          | 37.0                    | 38.5              |
| SDH50-400EU  | 58,200                        | 160,000               | 1,000        | 1,200     | 400          | 1,046        | 627     | 588     | 439          | 40.0                    | 41.5              |
| SDH50-500EU  | 72,700                        | 160,000               | 1,000        | 1,200     | 500          | 1,261        | 742     | 703     | 539          | 46.0                    | 47.5              |
| SDH50-600EU  | 87,300                        | 160,000               | 1,000        | 1,200     | 600          | 1,476        | 857     | 818     | 639          | 52.0                    | 53.5              |
| SDH50-700EU  | 101,800                       | 160,000               | 1,000        | 1,200     | 700          | 1,691        | 972     | 933     | 739          | 58.0                    | 59.5              |
| SDH50-800EU  | 116,400                       | 160,000               | 1,000        | 1,200     | 800          | 1,906        | 1,087   | 1,048   | 839          | 64.0                    | 65.5              |
| SDH50-1000EU | 145,500                       | 160,000               | 1,000        | 1,200     | 1,000        | 2,336        | 1,317   | 1,278   | 1,039        | 75.0                    | 76.5              |

1 The values apply to mounting style Front Flange and Foot Mounting. For mounting style Rear Flange, please consult ACE. In case of an existing side load angle, please consult ACE.

### SDH63EU-F Front Flange

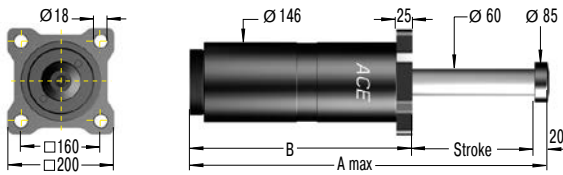

### SDH63EU-R Rear Flange

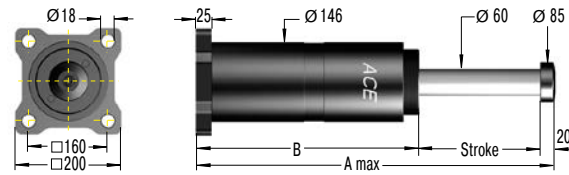

### SDH63EU-S Foot Mount

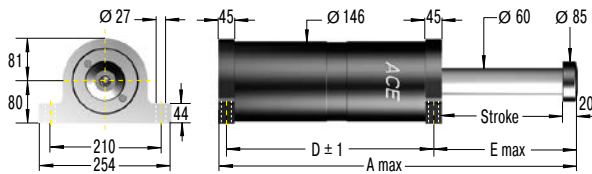

## Technical Data

Impact velocity range: 0.5 m/s to 4.6 m/s

### Complete details required when ordering

- Moving load: m (kg)
- Impact velocity range: v (m/s) max.
- Creep speed: vs (m/s)
- Motor power: P (kW)
- Stall torque factor: ST (normal, 2.5)
- (Alternatively: Propelling force F (N))
- Number of absorbers in parallel: n

or technical data according to formulae and calculations on page 265.

The calculation and selection of the most suitable damper should be carried out or be approved by ACE.

### Ordering Example

Safety Shock Absorber \_\_\_\_\_ **SDH63-400EU-F-XXXXX**  
 Bore Size Ø 63 mm \_\_\_\_\_  
 Stroke 400 mm \_\_\_\_\_  
 EU Compliant \_\_\_\_\_  
 Mounting Style: Front Flange \_\_\_\_\_  
 Identification No. assigned by ACE \_\_\_\_\_

**Please indicate identification no. in case of replacement order**

## Performance and Dimensions

| TYPES        | 1 Energy capacity<br>Nm/cycle | 1 Reacting Force<br>N | Return Force |           | Stroke<br>mm | A max.<br>mm | B<br>mm | D<br>mm | E max.<br>mm | Mounting Style          |                   |
|--------------|-------------------------------|-----------------------|--------------|-----------|--------------|--------------|---------|---------|--------------|-------------------------|-------------------|
|              |                               |                       | min.<br>N    | max.<br>N |              |              |         |         |              | F and R<br>Weight<br>kg | S<br>Weight<br>kg |
| SDH63-100EU  | 19,100                        | 210,000               | 1,500        | 2,500     | 100          | 420          | 301     | 252     | 144          | 32                      | 35                |
| SDH63-150EU  | 28,600                        | 210,000               | 1,500        | 2,500     | 150          | 520          | 351     | 302     | 194          | 35                      | 38                |
| SDH63-200EU  | 38,200                        | 210,000               | 1,500        | 2,500     | 200          | 620          | 401     | 352     | 244          | 39                      | 42                |
| SDH63-250EU  | 47,700                        | 210,000               | 1,500        | 2,500     | 250          | 720          | 451     | 402     | 294          | 43                      | 46                |
| SDH63-300EU  | 57,300                        | 210,000               | 1,500        | 2,500     | 300          | 850          | 531     | 482     | 344          | 48                      | 51                |
| SDH63-350EU  | 66,800                        | 210,000               | 1,500        | 2,500     | 350          | 950          | 581     | 532     | 394          | 52                      | 55                |
| SDH63-400EU  | 76,400                        | 210,000               | 1,500        | 2,500     | 400          | 1,080        | 661     | 612     | 444          | 60                      | 63                |
| SDH63-500EU  | 95,500                        | 210,000               | 1,500        | 2,500     | 500          | 1,280        | 761     | 712     | 544          | 68                      | 71                |
| SDH63-600EU  | 114,500                       | 210,000               | 1,500        | 2,500     | 600          | 1,510        | 891     | 842     | 644          | 78                      | 81                |
| SDH63-700EU  | 133,600                       | 210,000               | 1,500        | 2,500     | 700          | 1,740        | 1,021   | 972     | 744          | 88                      | 91                |
| SDH63-800EU  | 152,700                       | 210,000               | 1,500        | 2,500     | 800          | 1,970        | 1,151   | 1,102   | 844          | 98                      | 101               |
| SDH63-1000EU | 190,900                       | 210,000               | 1,500        | 2,500     | 1,000        | 2,430        | 1,411   | 1,362   | 1,044        | 118                     | 121               |
| SDH63-1200EU | 229,100                       | 210,000               | 1,500        | 2,500     | 1,200        | 2,890        | 1,671   | 1,622   | 1,244        | 138                     | 141               |

1 The values apply to mounting style Front Flange and Foot Mounting. For mounting style Rear Flange, please consult ACE.  
 In case of an existing side load angle, please consult ACE.

## SDP63 to SDP160

### High return forces with gas pressure accumulator

**Crane Installations, Optimized Characteristic**  
**Energy capacity 9,100 Nm/Cycle to 582,000 Nm/Cycle**  
**Stroke 50 mm to 1,200 mm**

**Reliability:** The emergency stop from the large scale SDP63 to SDP160 series have internal system seals. Even dirt or damages to the piston rod do not lead to a leakage or failure. Compressed gas accumulators allow return forces of up to 100 kN, which can make applications in multiple bridge crane systems safer, for example. The absorber body and the robust, large-sized piston rod bearing are also designed for heavy duty operations

Just like all ACE safety shock absorbers, the characteristic curve or damping characteristics of each individual absorber is individually adjusted to the respective application.

Whether its crane systems or machines in heavy duty applications e.g. in the metal industry or in mining, these powerful safety shock absorbers reliably protect construction designs against expensive failure.

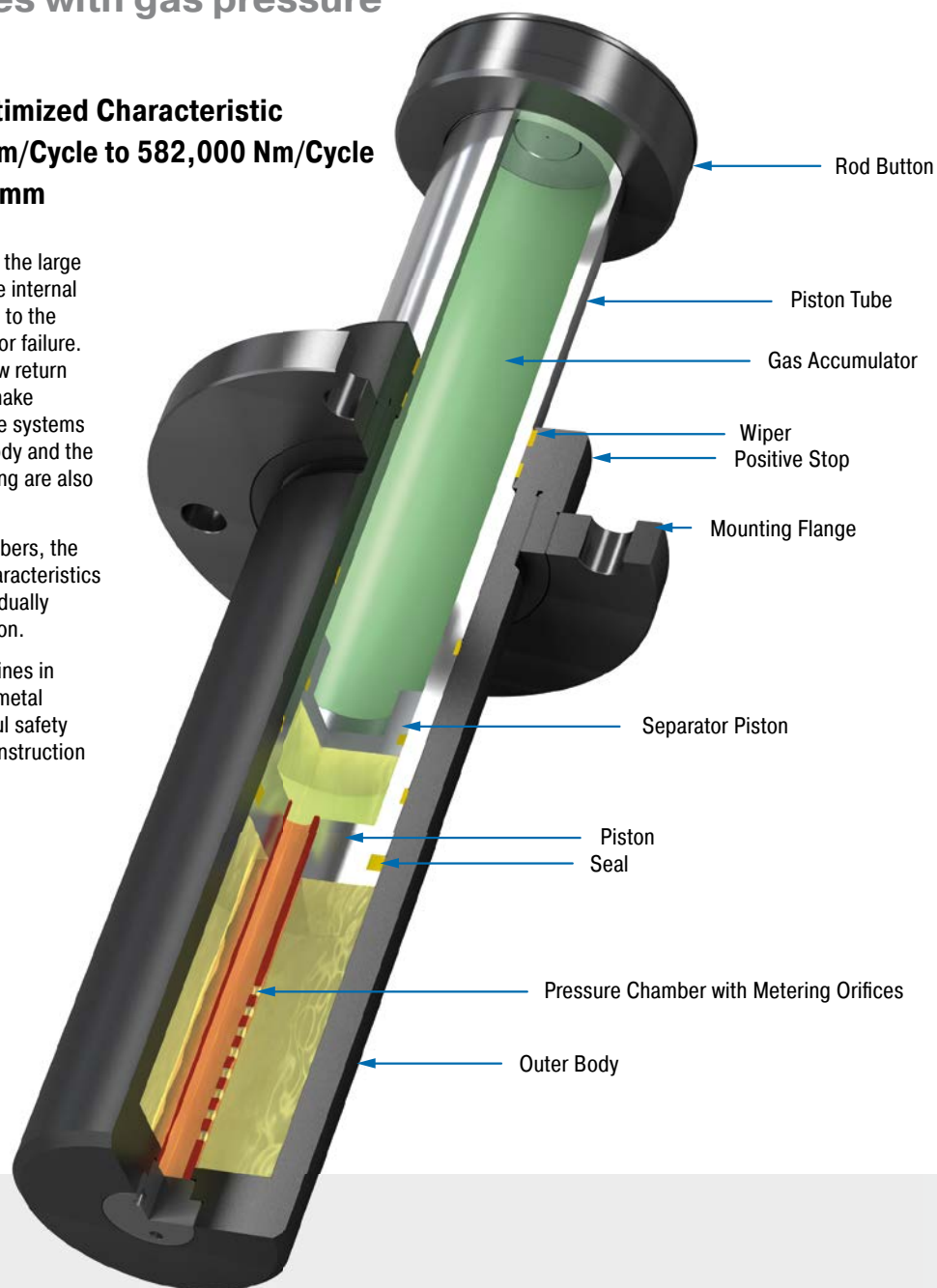

### Technical Data

**Energy capacity:** 9,100 Nm/Cycle to 582,000 Nm/Cycle

**Impact velocity range:** 0.5 m/s to 4.6 m/s. Other speeds on request.

**Reacting force:** At max. capacity rating = 110 kN to 1.000 kN

**Operating temperature range:** -20 °C to +60 °C. Other temperatures on request.

**Mounting:** In any position

**Positive stop:** Integrated

**Material:** Outer body: Painted steel; Rod end button: Steel; Piston tube: Hard chrome plated steel

**Damping medium:** HLP 46

**Filling pressure:** Approx. 5 bar. Rod return by integrated nitrogen accumulator.

**Application field:** Shelf storage systems, Heavy load applications

**Note:** The shock absorber can be pushed through its stroke. In creep speed conditions the shock absorber provides minimal resistance and there is no braking effect.

**On request:** Special oils, special flanges, additional corrosion protection etc.

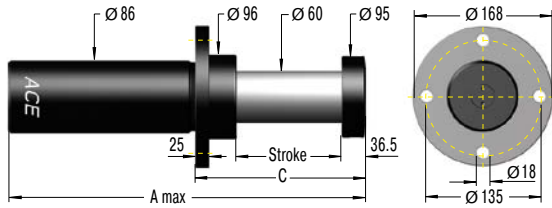
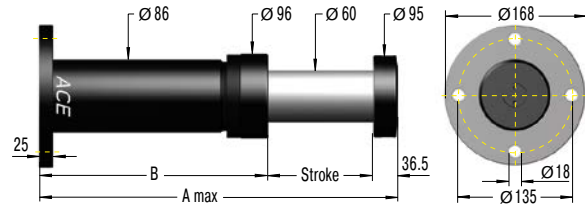
**SDP63EU-F Front Flange**

**SDP63EU-R Rear Flange**

**Technical Data**

**Impact velocity range:** 0.5 m/s to 4.6 m/s. Other speeds on request.

**The calculation and selection of the most suitable damper should be carried out or be approved by ACE.**

**Complete details required when ordering**

- Moving load: m (kg)
- Impact velocity range: v (m/s) max.
- Creep speed: vs (m/s)
- Motor power: P (kW)
- Stall torque factor: ST (normal, 2.5)
- (Alternatively: Propelling force F (N))
- Number of absorbers in parallel: n

or technical data according to formulae and calculations on page 265.

**Ordering Example**

**SDP63-400EU-F-XXXXX**

Safety Shock Absorber \_\_\_\_\_ ↑

Bore Size  $\varnothing$  63 mm \_\_\_\_\_ ↑

Stroke 400 mm \_\_\_\_\_ ↑

EU Compliant \_\_\_\_\_ ↑

Mounting Style: Front Flange \_\_\_\_\_ ↑

Identification No. assigned by ACE \_\_\_\_\_ ↑

**Please indicate identification no. in case of replacement order**

**Performance and Dimensions**

| TYPES       | Energy capacity<br>Nm/cycle | Reacting Force<br>N | Return Force min.<br>N | Return Force max.<br>N | Stroke<br>mm | A max.<br>mm | B<br>mm | C<br>mm | Weight<br>kg |
|-------------|-----------------------------|---------------------|------------------------|------------------------|--------------|--------------|---------|---------|--------------|
| SDP63-50EU  | 9,100                       | 200,000             | 1,500                  | 8,000                  | 50           | 280          | 193.5   | 145     | 11           |
| SDP63-75EU  | 13,600                      | 200,000             | 1,500                  | 10,000                 | 75           | 360          | 248.5   | 170     | 12.5         |
| SDP63-100EU | 18,200                      | 200,000             | 1,500                  | 11,000                 | 100          | 425          | 288.5   | 195     | 14           |
| SDP63-150EU | 27,300                      | 200,000             | 1,500                  | 15,000                 | 150          | 560          | 373.5   | 245     | 17           |
| SDP63-200EU | 36,400                      | 200,000             | 1,500                  | 17,000                 | 200          | 700          | 463.5   | 295     | 19           |
| SDP63-250EU | 43,200                      | 190,000             | 1,500                  | 18,000                 | 250          | 840          | 553.5   | 345     | 21           |
| SDP63-300EU | 49,100                      | 180,000             | 1,500                  | 20,000                 | 300          | 980          | 643.5   | 395     | 24           |
| SDP63-400EU | 54,500                      | 150,000             | 1,500                  | 20,000                 | 400          | 1,265        | 828.5   | 495     | 29           |
| SDP63-500EU | 59,100                      | 130,000             | 1,500                  | 20,000                 | 500          | 1,555        | 1,018.5 | 595     | 34           |
| SDP63-600EU | 60,000                      | 110,000             | 1,500                  | 20,000                 | 600          | 1,840        | 1,203.5 | 695     | 39           |

In case of an existing side load angle, please consult ACE.



**SDP80EU-F Front Flange**

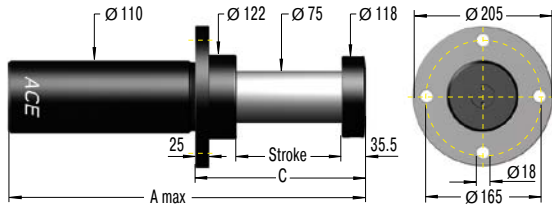

**SDP80EU-R Rear Flange**

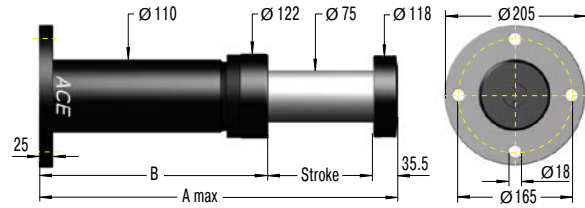

**Technical Data**

**Impact velocity range:** 0.5 m/s to 4.6 m/s. Other speeds on request.

**The calculation and selection of the most suitable damper should be carried out or be approved by ACE.**

**Complete details required when ordering**

- Moving load: m (kg)
- Impact velocity range: v (m/s) max.
- Creep speed: vs (m/s)
- Motor power: P (kW)
- Stall torque factor: ST (normal, 2.5)
- (Alternatively: Propelling force F (N))
- Number of absorbers in parallel: n

or technical data according to formulae and calculations on page 265.

**Ordering Example**

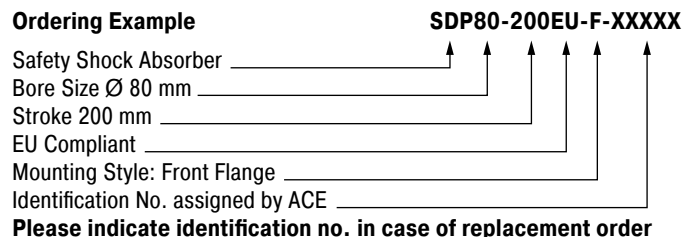

**Please indicate identification no. in case of replacement order**

**Performance and Dimensions**

| TYPES       | Energy capacity<br>Nm/cycle | Reacting Force<br>N | Return Force min.<br>N | Return Force max.<br>N | Stroke<br>mm | A max.<br>mm | B<br>mm | C<br>mm | Weight<br>kg |
|-------------|-----------------------------|---------------------|------------------------|------------------------|--------------|--------------|---------|---------|--------------|
| SDP80-50EU  | 11,800                      | 260,000             | 2,500                  | 16,000                 | 50           | 285          | 199.5   | 155     | 19           |
| SDP80-100EU | 23,600                      | 260,000             | 2,500                  | 16,000                 | 100          | 440          | 304.5   | 205     | 23           |
| SDP80-150EU | 35,500                      | 260,000             | 2,500                  | 20,000                 | 150          | 580          | 394.5   | 255     | 27           |
| SDP80-200EU | 47,300                      | 260,000             | 2,500                  | 20,000                 | 200          | 730          | 494.5   | 305     | 32           |
| SDP80-250EU | 56,800                      | 250,000             | 2,500                  | 25,000                 | 250          | 865          | 579.5   | 355     | 35           |
| SDP80-300EU | 65,500                      | 240,000             | 2,500                  | 25,000                 | 300          | 1,010        | 674.5   | 405     | 39           |
| SDP80-400EU | 80,000                      | 220,000             | 2,500                  | 30,000                 | 400          | 1,285        | 849.5   | 505     | 47           |
| SDP80-500EU | 90,900                      | 200,000             | 2,500                  | 30,000                 | 500          | 1,575        | 1,039.5 | 605     | 55           |
| SDP80-600EU | 98,200                      | 180,000             | 2,500                  | 30,000                 | 600          | 1,865        | 1,229.5 | 705     | 64           |
| SDP80-800EU | 101,800                     | 140,000             | 2,500                  | 30,000                 | 800          | 2,450        | 1,614.5 | 905     | 80           |

In case of an existing side load angle, please consult ACE.

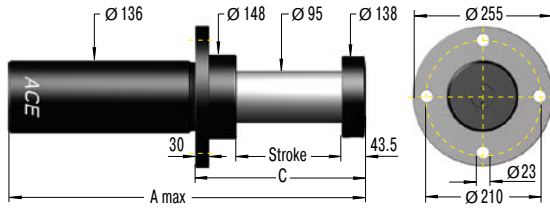
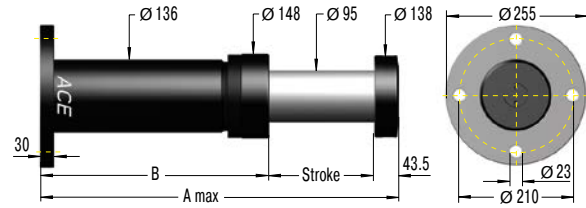
**SDP100EU-F Front Flange**

**SDP100EU-R Rear Flange**

**Technical Data**
**Impact velocity range:** 0.5 m/s to 4.6 m/s. Other speeds on request.

**The calculation and selection of the most suitable damper should be carried out or be approved by ACE.**
**Complete details required when ordering**

- Moving load: m (kg)
- Impact velocity range: v (m/s) max.
- Creep speed: vs (m/s)
- Motor power: P (kW)
- Stall torque factor: ST (normal, 2.5)
- (Alternatively: Propelling force F (N))
- Number of absorbers in parallel: n

or technical data according to formulae and calculations on page 265.

**Ordering Example**

**SDP100-400EU-F-XXXX**

Safety Shock Absorber \_\_\_\_\_ ↑

Bore Size Ø 100 mm \_\_\_\_\_ ↑

Stroke 400 mm \_\_\_\_\_ ↑

EU Compliant \_\_\_\_\_ ↑

Mounting Style: Front Flange \_\_\_\_\_ ↑

Identification No. assigned by ACE \_\_\_\_\_ ↑

**Please indicate identification no. in case of replacement order**
**Performance and Dimensions**

| TYPES         | Energy capacity<br>Nm/cycle | Reacting Force<br>N | Return Force min.<br>N | Return Force max.<br>N | Stroke<br>mm | A max.<br>mm | B<br>mm | C<br>mm | Weight<br>kg |
|---------------|-----------------------------|---------------------|------------------------|------------------------|--------------|--------------|---------|---------|--------------|
| SDP100-100EU  | 47,000                      | 520,000             | 3,900                  | 38,000                 | 100          | 460          | 316.5   | 230     | 38           |
| SDP100-200EU  | 95,000                      | 520,000             | 3,900                  | 38,000                 | 200          | 750          | 506.5   | 330     | 53           |
| SDP100-250EU  | 114,000                     | 520,000             | 3,900                  | 40,000                 | 250          | 890          | 596.5   | 380     | 59           |
| SDP100-300EU  | 131,000                     | 500,000             | 3,900                  | 40,000                 | 300          | 1,035        | 691.5   | 430     | 66           |
| SDP100-400EU  | 160,000                     | 480,000             | 3,900                  | 40,000                 | 400          | 1,325        | 881.5   | 530     | 81           |
| SDP100-500EU  | 182,000                     | 440,000             | 3,900                  | 40,000                 | 500          | 1,610        | 1,066.5 | 630     | 93           |
| SDP100-600EU  | 196,000                     | 360,000             | 3,900                  | 46,000                 | 600          | 1,880        | 1,236.5 | 730     | 103          |
| SDP100-800EU  | 218,000                     | 300,000             | 3,900                  | 46,000                 | 800          | 2,450        | 1,606.5 | 930     | 125          |
| SDP100-1000EU | 236,000                     | 260,000             | 3,900                  | 46,000                 | 1,000        | 3,020        | 1,976.5 | 1,130   | 160          |

In case of an existing side load angle, please consult ACE.

**SDP120EU-F Front Flange**

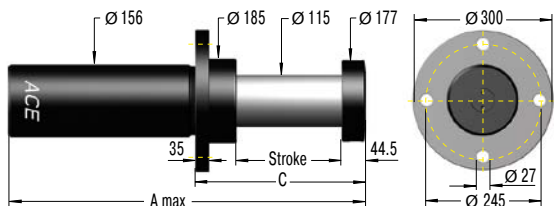

**SDP120EU-R Rear Flange**

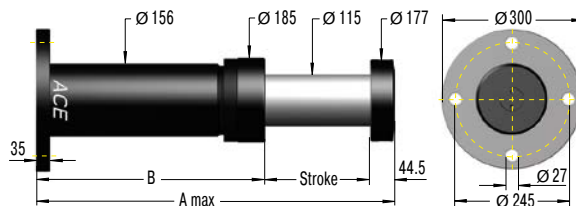

**Technical Data**

**Impact velocity range:** 0.5 m/s to 4.6 m/s. Other speeds on request.

**The calculation and selection of the most suitable damper should be carried out or be approved by ACE.**

**Complete details required when ordering**

- Moving load: m (kg)
- Impact velocity range: v (m/s) max.
- Creep speed: vs (m/s)
- Motor power: P (kW)
- Stall torque factor: ST (normal, 2.5)
- (Alternatively: Propelling force F (N))
- Number of absorbers in parallel: n

or technical data according to formulae and calculations on page 265.

**Ordering Example**

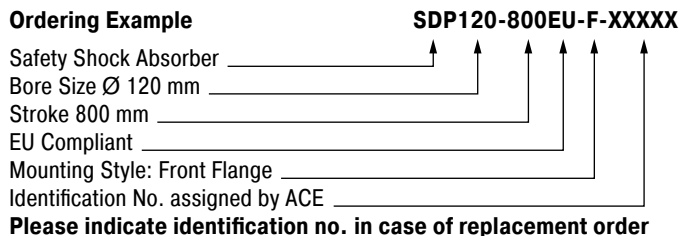

**Please indicate identification no. in case of replacement order**

**Performance and Dimensions**

| TYPES         | Energy capacity<br>Nm/cycle | Reacting Force<br>N | Return Force min.<br>N | Return Force max.<br>N | Stroke<br>mm | A max.<br>mm | B<br>mm | C<br>mm | Weight<br>kg |
|---------------|-----------------------------|---------------------|------------------------|------------------------|--------------|--------------|---------|---------|--------------|
| SDP120-100EU  | 64,000                      | 700,000             | 5,600                  | 35,000                 | 100          | 460          | 315.5   | 249     | 58           |
| SDP120-200EU  | 127,000                     | 700,000             | 5,600                  | 70,000                 | 200          | 750          | 505.5   | 355     | 72           |
| SDP120-400EU  | 236,000                     | 650,000             | 5,600                  | 75,000                 | 400          | 1,325        | 880.5   | 555     | 99           |
| SDP120-600EU  | 300,000                     | 550,000             | 5,600                  | 75,000                 | 600          | 1,880        | 1,235.5 | 755     | 125          |
| SDP120-800EU  | 327,000                     | 450,000             | 5,600                  | 75,000                 | 800          | 2,450        | 1,605.5 | 955     | 160          |
| SDP120-1000EU | 364,000                     | 400,000             | 5,600                  | 75,000                 | 1,000        | 3,020        | 1,975.5 | 1,155   | 192          |
| SDP120-1200EU | 436,000                     | 400,000             | 5,600                  | 75,000                 | 1,200        | 3,590        | 2,345.5 | 1,355   | 225          |

In case of an existing side load angle, please consult ACE.

Issue 07.2017 – Specifications subject to change

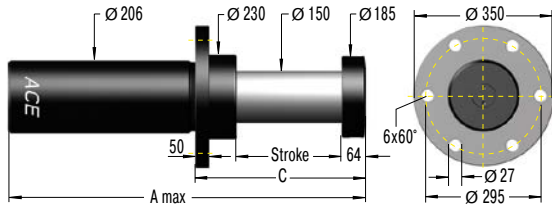
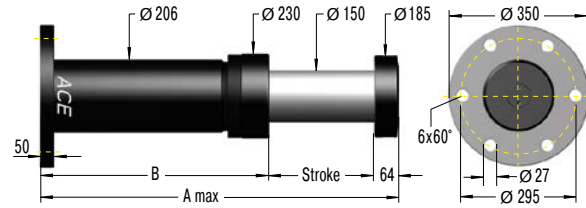
**SDP160EU-F Front Flange**

**SDP160EU-R Rear Flange**

**Technical Data**

**Impact velocity range:** 0.5 m/s to 4.6 m/s. Other speeds on request.

**The calculation and selection of the most suitable damper should be carried out or be approved by ACE.**

**Complete details required when ordering**

- Moving load: m (kg)
- Impact velocity range: v (m/s) max.
- Creep speed: vs (m/s)
- Motor power: P (kW)
- Stall torque factor: ST (normal, 2.5)
- (Alternatively: Propelling force F (N))
- Number of absorbers in parallel: n

or technical data according to formulae and calculations on page 265.

**Ordering Example**
**SDP160-400EU-F-XXXXX**

- Safety Shock Absorber \_\_\_\_\_
- Bore Size Ø 160 mm \_\_\_\_\_
- Stroke 400 mm \_\_\_\_\_
- EU Compliant \_\_\_\_\_
- Mounting Style: Front Flange \_\_\_\_\_
- Identification No. assigned by ACE \_\_\_\_\_

**Please indicate identification no. in case of replacement order**

**Performance and Dimensions**

| TYPES         | Energy capacity<br>Nm/cycle | Reacting Force<br>N | Return Force min.<br>N | Return Force max.<br>N | Stroke<br>mm | A max.<br>mm | B<br>mm | C<br>mm | Weight<br>kg |
|---------------|-----------------------------|---------------------|------------------------|------------------------|--------------|--------------|---------|---------|--------------|
| SDP160-200EU  | 182,000                     | 1,000,000           | 1,000                  | 80,000                 | 200          | 860          | 596     | 440     | 105          |
| SDP160-400EU  | 345,000                     | 950,000             | 1,000                  | 80,000                 | 400          | 1,485        | 1,021   | 640     | 165          |
| SDP160-500EU  | 409,000                     | 900,000             | 1,000                  | 90,000                 | 500          | 1,765        | 1,201   | 740     | 195          |
| SDP160-600EU  | 469,000                     | 860,000             | 1,000                  | 95,000                 | 600          | 2,065        | 1,401   | 840     | 230          |
| SDP160-800EU  | 545,000                     | 750,000             | 1,000                  | 100,000                | 800          | 2,660        | 1,796   | 1,040   | 290          |
| SDP160-1000EU | 545,000                     | 600,000             | 1,000                  | 110,000                | 1,000        | 3,225        | 2,161   | 1,240   | 350          |
| SDP160-1200EU | 545,000                     | 500,000             | 1,000                  | 110,000                | 1,200        | 3,815        | 2,551   | 1,440   | 410          |
| SDP160-1600EU | 582,000                     | 400,000             | 1,000                  | 110,000                | 1,600        | 4,995        | 3,331   | 1,840   | 530          |

In case of an existing side load angle, please consult ACE.

### Permitted Use

ACE safety shock absorbers are machine elements to brake moving masses in a defined end position in emergency stop situations for axial forces. The safety shock absorbers are not designed for regular operational usage.

### Calculation of safety shock absorbers

The calculation of safety shock absorbers should generally be performed or checked by ACE.

### Deceleration Properties

The orifice sizing and drill pattern in the pressure chamber are individually designed for each safety shock absorber. The respective absorption characteristic is optimised corresponding to the maximum mass that occurs in the emergency stop and the impact speed. Correspondingly, each safety shock absorber is given an individual identification number.

### Model Code

For types SCS33 to 64, the individual five-digit identification numbers can be taken from the last digits of the shock absorber model code shown on the label. Example: SCS33-50EU-1XXXX. For type series SDH38 to SDH63 and SDP63 to SDP160, the identification number is a five digit number. Example: SDH38-400EU-F-XXXXX. In addition to the model code, the label also shows the authorised maximum impact velocity and maximum authorised impact mass for the unit.

### Mounting

To mount the shock absorber, we recommend the use of original ACE mounting accessories shown in catalogue.

The mounting of each shock absorber must be exactly positioned so that the reaction force (Q) can be adequately transmitted into the mounting structure.

ACE recommends installation via the front flange -F mounting style that ensures the maximum protection against buckling. The damper must be mounted so that the moving loads are decelerated with the least possible side loading to the piston rod. The maximum permissible side load angles are detailed in our current catalogue.

The entire stroke length must be used for deceleration because only using part of the stroke can lead to overstressing and damage to the unit.

### Mounting style front flange



Safety Shock Absorber SDH



Safety Shock Absorber SDP

### Environmental Requirements

The permissible **temperature range** for each shock absorber type can be found in our current catalogue.

**Caution:** Usage outside the specified temperature range can lead to premature breakdown and damage of the shock absorbers which can then result in severe system damage or machine failures.

Trouble free operation outdoors or in damp environments is only warranted if the dampers are coated with a specific corrosion protection finish.

### Initial Start-Up Checks

First impacts on the shock absorber should only be tried after correctly mounting and with reduced impact speeds and – if possible – with reduced load. Differences between calculated and actual operating data can then be detected early on, and damage to your system can be avoided. If the shock absorbers were selected on calculated data that does not correspond to the maximum possible loading (i.e. selection based on drive power being switched off or at reduced impact speed) then these restricted impact conditions must not be exceeded during initial testing or subsequent use of the system. Otherwise you risk damaging the shock absorbers and/or your machine by overstressing materials. After the initial trial check that the piston rod fully extends again and that there are no signs of oil leakage. Also check that the mounting hardware is still securely tightened. You need to satisfy yourself that no damage has occurred to the piston rod, the body, or the mounting hardware.

### Fixed Mechanical Stop

Safety shock absorbers do not need an external stop as a stroke limiter. The stroke of the safety absorber is limited by the stop of the impact head on the shock absorber. For types SCS33 to SCS64, the fixed stop point is achieved with the integrated stop collar.

### What Needs to be Checked after a Full Load Impact?

Safety shock absorbers that were originally checked only at reduced speed or load need to be checked again after a full load impact (i.e. emergency use) has occurred. Check that the piston rod fully extends to its full out position, that there are no signs of oil leakage and that the mounting hardware is still securely fixed. You need to satisfy yourself that no damage has occurred to the piston rod, the body, or the mounting hardware. If no damage has occurred, the safety shock absorber can be put back into normal operation (see **initial start-up**).

### Maintenance

Safety shock absorbers are sealed systems and do not need special maintenance. Safety shock absorbers that are not used regularly (i.e. that are intended for emergency stop systems) should be checked within the normal time frame for safety checks, but **at least once a year**. At this time special attention must be paid to checking that the piston rod resets to its fully extended position, that there is no oil leakage and that the mounting brackets are still secure and undamaged. The piston rod must not show any signs of damage. Safety shock absorbers that are **in use regularly** should be checked **every three months**.

### Repair Notice

If any damage to the shock absorber is detected or if there are any doubts as to the proper functioning of the unit please send the unit for service to ACE. Alternatively contact your local ACE office for further advice.

Detailed information on the above listed points can be taken from the corresponding operating and assembly instructions.

### Calculation Bases for the Design of Safety Shock Absorbers

More formulae on page 10 to 13

ACE shock absorbers provide linear deceleration and are therefore superior to other kinds of damping element. It is easy to calculate around 90 % of applications knowing only the following four parameters:

1. Mass to be decelerated (weight) **m** [kg]
2. Impact velocity at shock absorber **v<sub>D</sub>** [m/s]
3. Propelling force **F** [N]
4. Number of absorbers in parallel **n**

#### Key to symbols used



|           |   |       |           |                                   |                  |
|-----------|---|-------|-----------|-----------------------------------|------------------|
| $W_1$     | Kinetic energy per cycle                | Nm    | ${}^2v_D$ | Impact velocity at shock absorber | m/s              |
| $W_2$     | Propelling force energy per cycle       | Nm    | F         | Propelling force                  | N                |
| $W_3$     | Total energy per cycle ( $W_1 + W_2$ )  | Nm    | c         | Cycles per hour                   | 1/hr             |
| ${}^1W_4$ | Total energy per hour ( $W_3 \cdot x$ ) | Nm/hr | s         | Shock absorber stroke             | m                |
| me        | Effective weight                        | kg    | Q         | Reaction force                    | N                |
| m         | Mass to be decelerated                  | kg    | t         | Deceleration time                 | s                |
| n         | Number of shock absorbers (in parallel) |       | a         | Deceleration                      | m/s <sup>2</sup> |
| ${}^2v$   | Velocity at impact                      | m/s   |           |                                   |                  |

<sup>1</sup> All mentioned values of W4 in the capacity charts are only valid for room temperature. There are reduced values at higher temperature ranges.

<sup>2</sup> v or v<sub>D</sub> is the final impact velocity of the mass. With accelerating motion the final impact velocity can be 1.5 to 2 times higher than the average. Please take this into account when calculating kinetic energy.

In all the following examples the choice of shock absorbers made from the capacity chart is based upon the values of ( $W_3$ ), ( $W_4$ ), (me) and the desired shock absorber stroke (s).

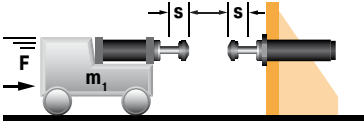
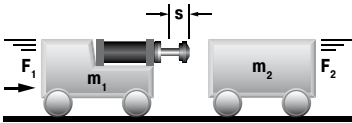
**Note:** When using several shock absorbers in parallel, the values ( $W_3$ ), ( $W_4$ ) and (me) are divided according to the number of units used.

| Application  | Formulae  | Example  |             |  |           |                          |                         |          |                           |                    |           |                          |                         |            |            |  |  |                     |  |  |
|--|---|--|-------------|--|-----------|--------------------------|-------------------------|----------|---------------------------|--------------------|-----------|--------------------------|-------------------------|------------|------------|--|--|---------------------|--|--|
| <b>19 Wagon against 2 shock absorbers</b><br>       | $W_1 = m \cdot v^2 \cdot 0.25$<br>$W_2 = F \cdot s$<br>$W_3 = W_1 + W_2$<br>$v_D = v \cdot 0.5$   | <table border="0"> <tr> <td>m = 5000 kg</td> <td><math>W_1 = 5000 \cdot 2^2 \cdot 0.25</math></td> <td>= 5000 Nm</td> </tr> <tr> <td>v = 2 m/s</td> <td><math>W_2 = 3500 \cdot 0.10</math></td> <td>= 350 Nm</td> </tr> <tr> <td>F = 3500 N</td> <td><math>W_3 = 5000 + 350</math></td> <td>= 5350 Nm</td> </tr> <tr> <td>s = 0.10 m (chosen)</td> <td><math>v_D = 2 \cdot 0.5</math></td> <td>= 1 m/s</td> </tr> </table> <p>Chosen from capacity chart:<br/>Model SDH38-100EU self-compensating</p>  | m = 5000 kg | $W_1 = 5000 \cdot 2^2 \cdot 0.25$                                      | = 5000 Nm | v = 2 m/s                | $W_2 = 3500 \cdot 0.10$ | = 350 Nm | F = 3500 N                | $W_3 = 5000 + 350$ | = 5350 Nm | s = 0.10 m (chosen)      | $v_D = 2 \cdot 0.5$     | = 1 m/s    |            |  |  |                     |  |  |
| m = 5000 kg  | $W_1 = 5000 \cdot 2^2 \cdot 0.25$   | = 5000 Nm  |             |  |           |                          |                         |          |                           |                    |           |                          |                         |            |            |  |  |                     |  |  |
| v = 2 m/s  | $W_2 = 3500 \cdot 0.10$   | = 350 Nm   |             |  |           |                          |                         |          |                           |                    |           |                          |                         |            |            |  |  |                     |  |  |
| F = 3500 N   | $W_3 = 5000 + 350$  | = 5350 Nm  |             |  |           |                          |                         |          |                           |                    |           |                          |                         |            |            |  |  |                     |  |  |
| s = 0.10 m (chosen)  | $v_D = 2 \cdot 0.5$   | = 1 m/s  |             |  |           |                          |                         |          |                           |                    |           |                          |                         |            |            |  |  |                     |  |  |
| <b>20 Wagon against wagon</b><br>                   | $W_1 = \frac{m_1 \cdot m_2}{(m_1 + m_2)} \cdot (v_1 + v_2)^2 \cdot 0.5$<br>$W_2 = F \cdot s$<br>$W_3 = W_1 + W_2$<br>$v_D = v_1 + v_2$            | <table border="0"> <tr> <td>m = 7000 kg</td> <td><math>W_1 = \frac{7000 \cdot 10000}{(7000 + 10000)} \cdot 1.7^2 \cdot 0.5</math></td> <td>= 5950 Nm</td> </tr> <tr> <td>v<sub>1</sub> = 1.2 m/s</td> <td><math>W_2 = 5000 \cdot 0.10</math></td> <td>= 500 Nm</td> </tr> <tr> <td>m<sub>2</sub> = 10000 kg</td> <td><math>W_3 = 5950 + 500</math></td> <td>= 6450 Nm</td> </tr> <tr> <td>v<sub>2</sub> = 0.5 m/s</td> <td><math>v_D = 1.2 + 0.5</math></td> <td>= 1.7 m/s</td> </tr> <tr> <td>F = 5000 N</td> <td></td> <td></td> </tr> <tr> <td>s = 0.10 m (chosen)</td> <td></td> <td></td> </tr> </table> <p>Chosen from capacity chart:<br/>Model SDH50-100EU self-compensating</p>         | m = 7000 kg | $W_1 = \frac{7000 \cdot 10000}{(7000 + 10000)} \cdot 1.7^2 \cdot 0.5$  | = 5950 Nm | v <sub>1</sub> = 1.2 m/s | $W_2 = 5000 \cdot 0.10$ | = 500 Nm | m <sub>2</sub> = 10000 kg | $W_3 = 5950 + 500$ | = 6450 Nm | v <sub>2</sub> = 0.5 m/s | $v_D = 1.2 + 0.5$       | = 1.7 m/s  | F = 5000 N |  |  | s = 0.10 m (chosen) |  |  |
| m = 7000 kg  | $W_1 = \frac{7000 \cdot 10000}{(7000 + 10000)} \cdot 1.7^2 \cdot 0.5$   | = 5950 Nm  |             |  |           |                          |                         |          |                           |                    |           |                          |                         |            |            |  |  |                     |  |  |
| v <sub>1</sub> = 1.2 m/s   | $W_2 = 5000 \cdot 0.10$   | = 500 Nm   |             |  |           |                          |                         |          |                           |                    |           |                          |                         |            |            |  |  |                     |  |  |
| m <sub>2</sub> = 10000 kg  | $W_3 = 5950 + 500$  | = 6450 Nm  |             |  |           |                          |                         |          |                           |                    |           |                          |                         |            |            |  |  |                     |  |  |
| v <sub>2</sub> = 0.5 m/s   | $v_D = 1.2 + 0.5$   | = 1.7 m/s  |             |  |           |                          |                         |          |                           |                    |           |                          |                         |            |            |  |  |                     |  |  |
| F = 5000 N   |   |  |             |  |           |                          |                         |          |                           |                    |           |                          |                         |            |            |  |  |                     |  |  |
| s = 0.10 m (chosen)  |   |  |             |  |           |                          |                         |          |                           |                    |           |                          |                         |            |            |  |  |                     |  |  |
| <b>21 Wagon against wagon 2 shock absorbers</b><br> | $W_1 = \frac{m_1 \cdot m_2}{(m_1 + m_2)} \cdot (v_1 + v_2)^2 \cdot 0.25$<br>$W_2 = F \cdot s$<br>$W_3 = W_1 + W_2$<br>$v_D = \frac{v_1 + v_2}{2}$ | <table border="0"> <tr> <td>m = 7000 kg</td> <td><math>W_1 = \frac{7000 \cdot 10000}{(7000 + 10000)} \cdot 1.7^2 \cdot 0.25</math></td> <td>= 2975 Nm</td> </tr> <tr> <td>v<sub>1</sub> = 1.2 m/s</td> <td><math>W_2 = 5000 \cdot 0.10</math></td> <td>= 500 Nm</td> </tr> <tr> <td>m<sub>2</sub> = 10000 kg</td> <td><math>W_3 = 2975 + 510</math></td> <td>= 3475 Nm</td> </tr> <tr> <td>v<sub>2</sub> = 0.5 m/s</td> <td><math>v_D = (1.2 + 0.5) : 2</math></td> <td>= 0.85 m/s</td> </tr> <tr> <td>F = 5000 N</td> <td></td> <td></td> </tr> <tr> <td>s = 0.10 m (chosen)</td> <td></td> <td></td> </tr> </table> <p>Chosen from capacity chart:<br/>Model SDH38-100EU self-compensating</p> | m = 7000 kg | $W_1 = \frac{7000 \cdot 10000}{(7000 + 10000)} \cdot 1.7^2 \cdot 0.25$ | = 2975 Nm | v <sub>1</sub> = 1.2 m/s | $W_2 = 5000 \cdot 0.10$ | = 500 Nm | m <sub>2</sub> = 10000 kg | $W_3 = 2975 + 510$ | = 3475 Nm | v <sub>2</sub> = 0.5 m/s | $v_D = (1.2 + 0.5) : 2$ | = 0.85 m/s | F = 5000 N |  |  | s = 0.10 m (chosen) |  |  |
| m = 7000 kg  | $W_1 = \frac{7000 \cdot 10000}{(7000 + 10000)} \cdot 1.7^2 \cdot 0.25$  | = 2975 Nm  |             |  |           |                          |                         |          |                           |                    |           |                          |                         |            |            |  |  |                     |  |  |
| v <sub>1</sub> = 1.2 m/s   | $W_2 = 5000 \cdot 0.10$   | = 500 Nm   |             |  |           |                          |                         |          |                           |                    |           |                          |                         |            |            |  |  |                     |  |  |
| m <sub>2</sub> = 10000 kg  | $W_3 = 2975 + 510$  | = 3475 Nm  |             |  |           |                          |                         |          |                           |                    |           |                          |                         |            |            |  |  |                     |  |  |
| v <sub>2</sub> = 0.5 m/s   | $v_D = (1.2 + 0.5) : 2$   | = 0.85 m/s   |             |  |           |                          |                         |          |                           |                    |           |                          |                         |            |            |  |  |                     |  |  |
| F = 5000 N   |   |  |             |  |           |                          |                         |          |                           |                    |           |                          |                         |            |            |  |  |                     |  |  |
| s = 0.10 m (chosen)  |   |  |             |  |           |                          |                         |          |                           |                    |           |                          |                         |            |            |  |  |                     |  |  |



# Application Examples

## SCS45EU

### Controlled emergency stop

ACE safety shock absorbers protect precision assembly jigs for the aircraft industry. The basic mount of this coordinate measuring machine for the production of parts in the aircraft industry is made of granite and must not be damaged. To avoid damage from operating errors or mishandling, all movement axes were equipped with safety shock absorbers of the type SCS45-50EU. If the turntables malfunction the safety shock absorbers decelerate the loads before expensive damage can occur to the granite measuring tables.



Optimally protected turntable

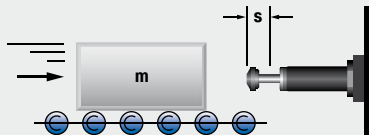

## SCS33EU, SCS45EU

### High-level protection of linear modules

Safety shock absorbers produced by ACE are installed in the top linear system models of one of the most prestigious companies in the field of drive and control technology. Their job: to protect the z-axis from damage caused by uncontrolled movements. Various safety dampers are used for different load ranges. Tests have shown that, in the worst case, a collision speed of up to 5 m/s might occur. To be on the safe side, the interpretations were based in all cases on a slightly higher value.



For protecting equipment and modules such as these, the SCS series from ACE is the ideal solution in the emergency stop sector  
Roth GmbH & Co. KG, 90411 Nürnberg, Germany and Bosch Rexroth AG, 97816 Lohr am Main, Germany

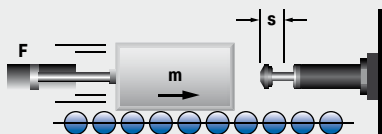

**SDP160EU**

**Customized buffer beam dampers**

Driving into lock gates should be specifically facilitated when navigating through Dutch river locks. That is why ACE developed special dampers, based on existing safety shock absorbers but with optimized characteristics, a fixed stop and a stroke of 800 mm. These are able to absorb 500,000 Nm, which means they can cope with fully loaded ships and also the mechanical impacts resulting from water movement. To return to the initial position, the safety shock absorbers operate on the same nitrogen-based principle as the gas springs produced by the damping specialists in Langenfeld.

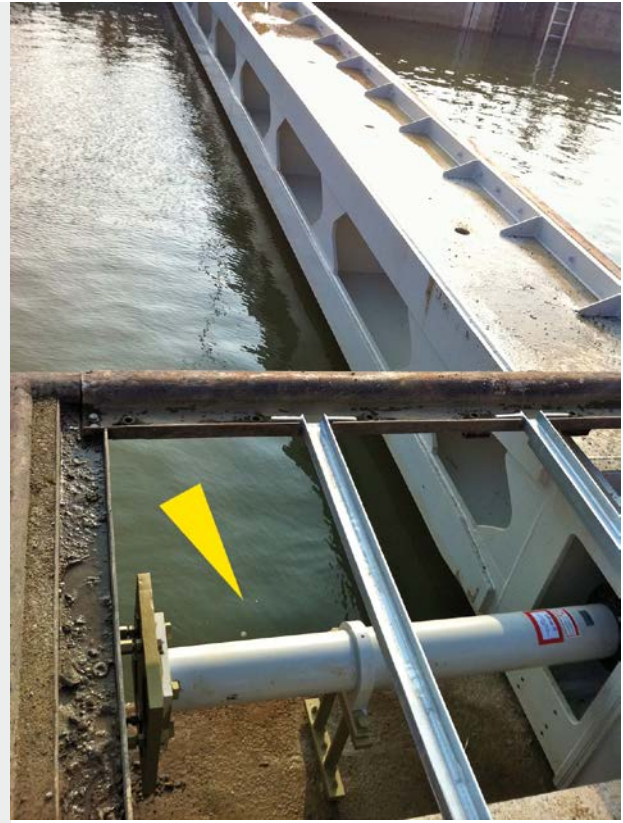
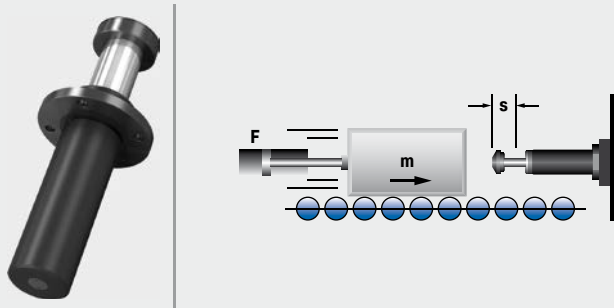

Heavy safety shock absorbers, which are specially designed for this application, are able to brake in lock masses of up to four million kg Mourik Limburg BV, 6101 AJ Echt, Netherlands

**SDH38EU**

**Safe driving to the end positions**

The aim was to protect a driving simulation capsule on two of its eight axes. The demands placed on a potential emergency stopper were high because it was clear that its failure would lead to massive damage to the complete construction as well as to the capsule. Even the possibility of damage to the health of the test personnel could not be ruled out and was taken into consideration in a diverse range of mass-speed combinations. Two ACE safety shock absorbers now safely contain destructive forces, e.g. during power outages, and eliminate high risks.

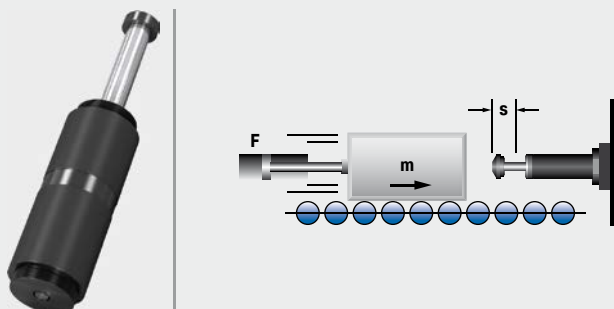

ACE safety shock absorbers protect end positions in two axes of a driving simulator Bosch Rexroth BV, Boxel 5281 RV, The Netherlands and University of Stuttgart - FKFS, 70569 Stuttgart, Germany

# Safety Dampers

## Top for emergency stopping

**The extremely successful TUBUS series from ACE is suitable for emergency stopping, as overrun protection or as end stop dampers. Available in different variations for heavy duty or crane installations, these profile dampers are perfect when loads do not need to be instantly decelerated or when working under extreme conditions.**

Manufactured in co-polyester elastomer, the highly resistant absorbers provide high force and energy absorption in areas where other materials fail or where a similarly high service life of up to 1 million load changes cannot be achieved. They are cost-effective and distinguished by the small, light design. With energy absorption within a range of 450 Nm and 17,810 Nm, they can be considered as an alternative to hydraulic end position damping.



## Safety Dampers



### TUBUS TC and TC-S

Page 270

Crane Installations

**Compact powerhouse**

Crane systems, Loading and lifting equipment, Hydraulic devices,  
Electro-mechanical drives



### TUBUS TI

Page 272

Irreversible Emergency Stop Damper

**Compact one-off deceleration**

Emergency stop damping in linear axes, Portal systems, Test stations,  
Electro-mechanical drives

Extremely durable

Highly resistant co-polyester elastomers

Lightweight designs

Cost-effective use

Heavy-duty versions available





# TUBUS TC and TC-S

## Compact powerhouse

### Crane Installations

**Energy capacity 630 Nm/Cycle to 17,810 Nm/Cycle**

**Maximum stroke 30 mm to 198 mm**

For even more protection: The profile dampers from the TC range of the ACE TUBUS-Series can also be used as safety dampers. These maintenance-free, ready-to-install damping elements made of co-polyester elastomer have been specially developed for use in crane systems and fulfil the international industry standards OSHA and CMAA. In the special TC-S design, managed to achieve the spring rate required for crane systems with the unique dual concept.

Whether TC-S or TC, this range of models represents a cost-effective solution with high energy absorption for energy management systems. The very small and light design of Ø 64 mm to Ø 176 mm progressively covers energy absorption within a range of 450 Nm to 17,810 Nm.

The profile dampers from the TC range protect cranes, loading and lifting equipment, hydraulic units and much more.

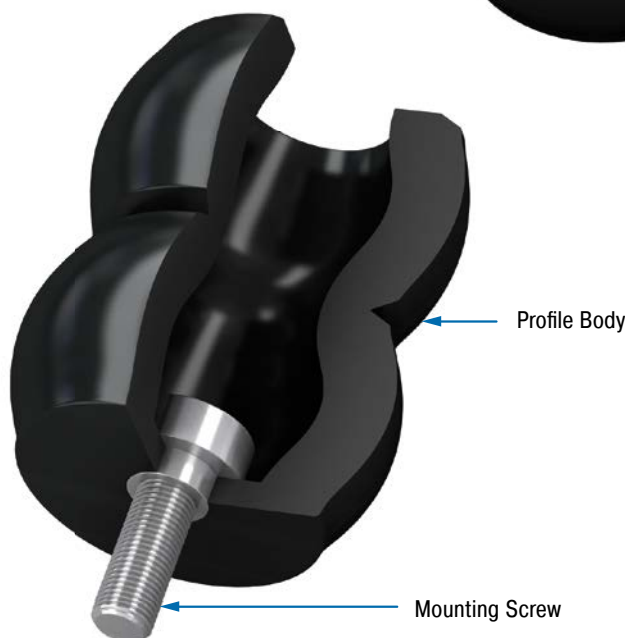

### Technical Data

**Energy capacity:** 630 Nm/Cycle to 17,810 Nm/Cycle

**Energy absorption:** 31 % to 64 %

**Dynamic force range:** 80,000 N to 978,000 N

**Operating temperature range:** -40 °C to +90 °C

**Construction size:** 64 mm to 176 mm

**Material hardness rating:** Shore 55D

**Material:** Profile body: Co-Polyester Elastomer

**Mounting:** In any position

**Environment:** Resistant to microbes, seawater or chemical attack. Excellent UV and ozone resistance. Material does not absorb water or swell.

**Impact velocity range:** Max. 5 m/s

**Torque max.:**

M12: 50 Nm

M16: 40 Nm (DIN912)

M16: 120 Nm (shouldered screw)

**Application field:** Crane systems, Loading and lifting equipment, Hydraulic devices, Electro-mechanical drives

**Note:** Suitable for emergency stop applications and for continuous use. For applications with preloading and increased temperatures please consult ACE.

**On request:** Special strokes, -characteristics, -spring rates, -sizes and -materials.

### TC

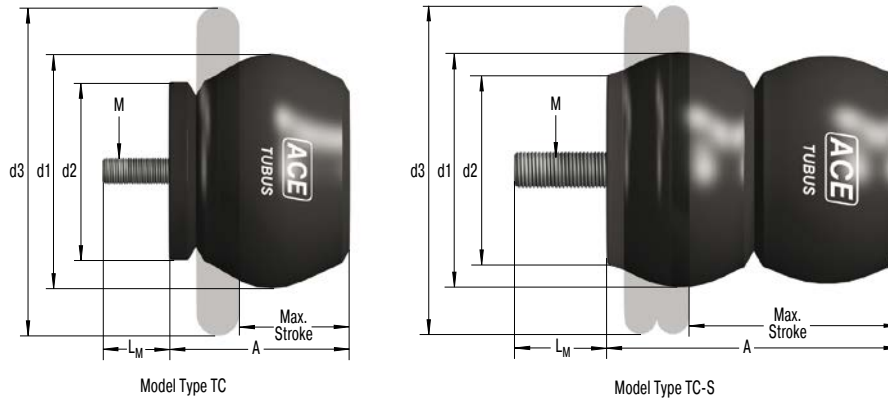

### Characteristics

#### Type TC90-49

Energy-Stroke Characteristic (dynamic)  
(with impact velocity over 0.5 m/s)

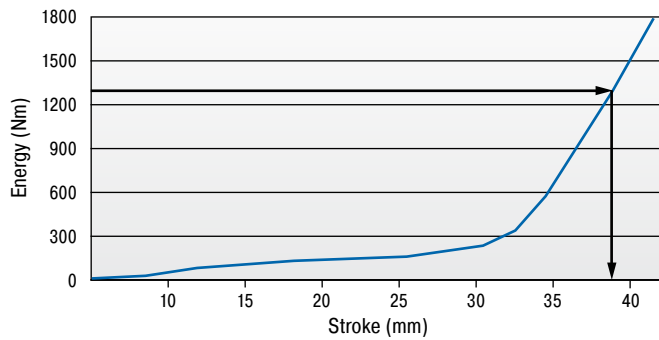

#### Type TC90-49

Force-Stroke Characteristic (dynamic)  
(with impact velocity over 0.5 m/s)

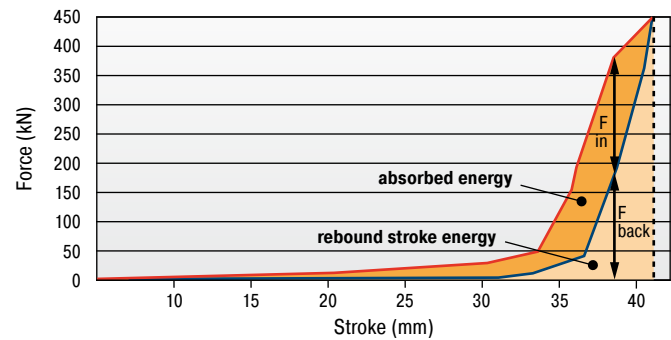

With the aid of the characteristic curves above you can estimate the proportion of the total energy that will be absorbed.

Example: With impact energy of 1,300 Nm the Energy-Stroke diagram shows that a stroke of about 38 mm is needed.

On the Force-Stroke diagram you can estimate the proportion of absorbed energy to rebound energy at this stroke length.

Note: With these types the return force towards the end of the stroke is significant and we recommend you try to use a minimum of 90 % of the total stroke available.

**Dynamic ( $v > 0.5$  m/s) and static ( $v \leq 0.5$  m/s) characteristics of all types are available on request.**

The calculation and selection of the most suitable damper should be carried out or be approved by ACE.

#### Ordering Example

TUBUS Crane Buffer \_\_\_\_\_ **TC83-73-S**  
 Outer-Ø 83 mm \_\_\_\_\_  
 Stroke 73 mm \_\_\_\_\_  
 Model Type Soft \_\_\_\_\_

### Performance and Dimensions

| TYPES       | Emergency Stop                          |                            | Stroke max.<br>mm | A<br>mm | d1<br>mm | d2<br>mm | d3<br>mm | L <sub>M</sub><br>mm | M   | Weight<br>kg |
|-------------|---|----------------------------|-------------------|---------|----------|----------|----------|----------------------|-----|--------------|
|             | <sup>1</sup> W <sub>3</sub><br>Nm/cycle | W <sub>3</sub><br>Nm/cycle |                   |         |          |          |          |                      |     |              |
| TC64-62-S   | 450                                     | 630                        | 62                | 79      | 64       | 52       | 89       | 12                   | M12 | 0.174        |
| TC74-76-S   | 980                                     | 1,372                      | 76                | 96      | 74       | 61       | 114      | 12                   | M12 | 0.260        |
| TC83-73-S   | 1,940                                   | 2,715                      | 73                | 94      | 83       | 69       | 127      | 12                   | M12 | 0.328        |
| TC86-39     | 1,210                                   | 1,695                      | 39                | 56      | 86       | 78       | 133      | 12                   | M12 | 0.284        |
| TC90-49     | 1,640                                   | 2,295                      | 49                | 68      | 90       | 67       | 124      | 12                   | M12 | 0.264        |
| TC100-59    | 1,785                                   | 2,500                      | 59                | 84      | 100      | 91       | 149      | 12                   | M12 | 0.452        |
| TC102-63    | 1,970                                   | 2,760                      | 63                | 98      | 102      | 82       | 140      | 22                   | M16 | 0.662        |
| TC108-30    | 1,900                                   | 2,660                      | 30                | 53      | 108      | 77       | 133      | 12                   | M12 | 0.392        |
| TC117-97    | 3,710                                   | 5,195                      | 97                | 129     | 117      | 100      | 188      | 16                   | M16 | 1.043        |
| TC134-146-S | 7,310                                   | 10,230                     | 146               | 188     | 134      | 117      | 215      | 30                   | M16 | 1.573        |
| TC136-65    | 4,250                                   | 5,950                      | 65                | 106     | 136      | 106      | 178      | 16                   | M16 | 1.147        |
| TC137-90    | 6,350                                   | 8,890                      | 90                | 115     | 137      | 113      | 216      | 21                   | M16 | 1.201        |
| TC146-67-S  | 8,330                                   | 11,660                     | 67                | 118     | 146      | 99       | 191      | 16                   | M16 | 1.573        |
| TC150-178-S | 8,860                                   | 12,400                     | 178               | 241     | 150      | 132      | 224      | 16                   | M16 | 2.674        |
| TC153-178-S | 7,260                                   | 10,165                     | 178               | 226     | 153      | 131      | 241      | 16                   | M16 | 2.522        |
| TC168-124   | 10,100                                  | 14,140                     | 124               | 166     | 168      | 147      | 260      | 16                   | M16 | 2.533        |
| TC176-198-S | 12,725                                  | 17,810                     | 198               | 252     | 176      | 150      | 279      | 16                   | M16 | 3.685        |

<sup>1</sup> Max. energy capacity per cycle for continuous use.



# TUBUS TI

## Compact one-off deceleration

### Irreversible Emergency Stop Damper

**Energy capacity 562 Nm/Cycle to 10,953 Nm/Cycle**

**Maximum stroke 25 mm to 80 mm**

Once only, but safely: ACE now offers these innovative single use TUBUS TI absorbers for emergency stop applications as an alternative to the successful TUBUS profile dampers. In comparison to standard elastomer absorbers, these safety dampers ensure energy absorption of up to 96 % without a recoil effect. The dampers are deformed in the impact and cannot be reused afterwards.

The easy to assemble and maintenance-free single hit damper are also a cost-effective alternative to the hydraulic safety shock absorbers from ACE. They are made of a high quality synthetic with an inside metal core and absorb up to 10,953 Nm energy.

The TUBUS TI is mainly used as emergency stop damping in linear axes, tool machines, servo drives with high speeds and other similar areas.

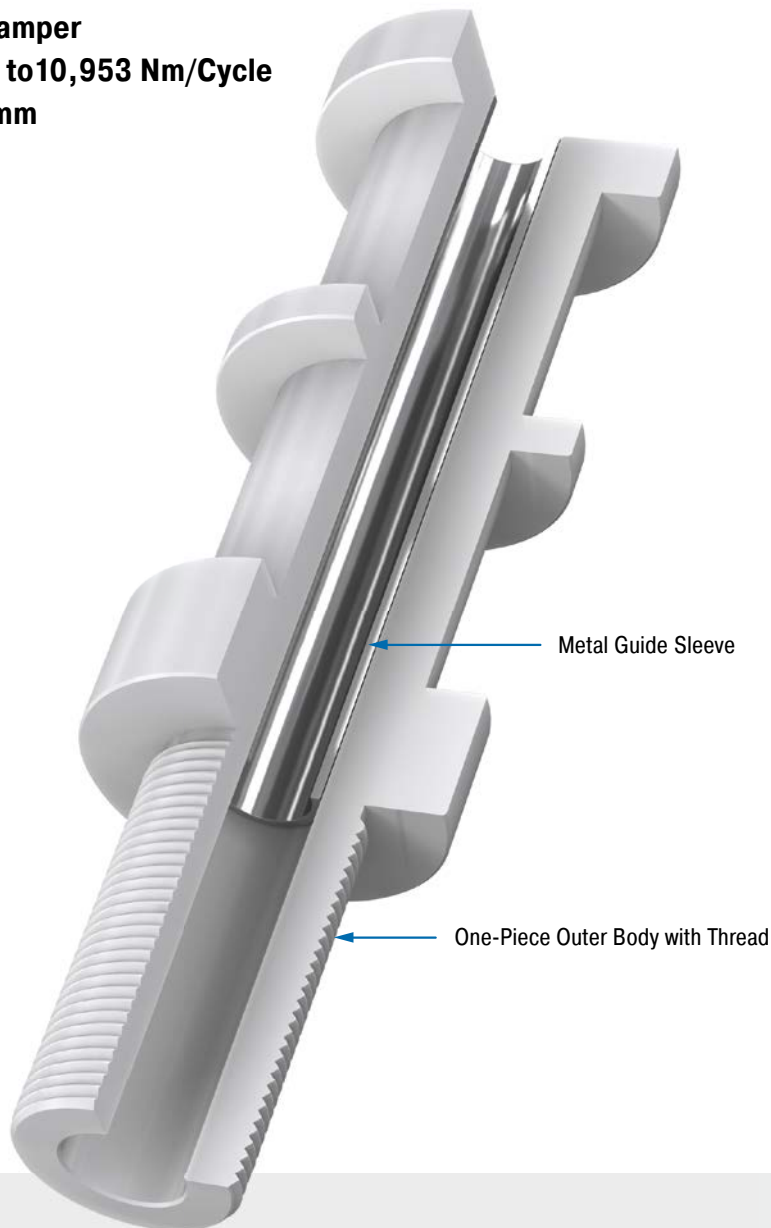

### Technical Data

**Energy capacity:** 562 Nm/Cycle to 10,953 Nm/Cycle

**Energy absorption:** 91 % to 96 %

**Dynamic force range:** 37,138 N to 204,127 N

**Operating temperature range:**

-40 °C to +90 °C, Co-polyester Elastomer  
-25 °C to +50 °C, Polymer

**Construction size:** 32 mm to 63 mm

**Material:** Profile body: Co-Polyester elastomer or polymer; Guide sleeve: Metal

**Mounting:** In any position

**Environment:** Resistant to lubricants and chemical attack according to resistance list. No UV resistance.

**Impact velocity range:** Max. 5 m/s

**Torque max.:** Finger tight

**Application field:** Emergency stop damping in linear axes, Portal systems, Test stations, Electro-mechanical drives

**Note:** The single-use damper must be replaced after each impact.

**On request:** Other construction sizes on request.

### TI16

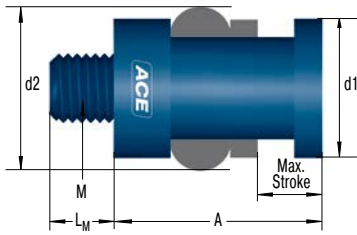

### TI24

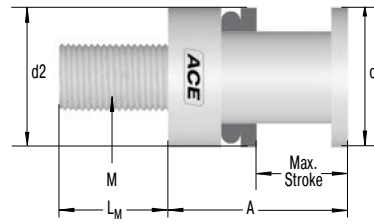

### TI30

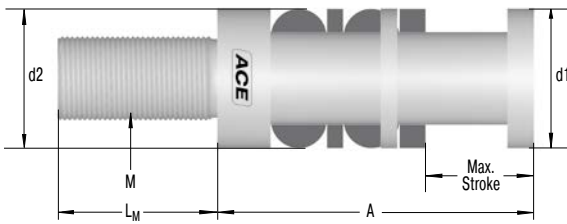

### TI36

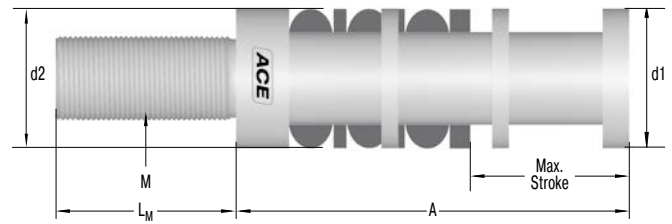

## Characteristics

### Force-Stroke TI16

Dynamic trials on a drop test rig

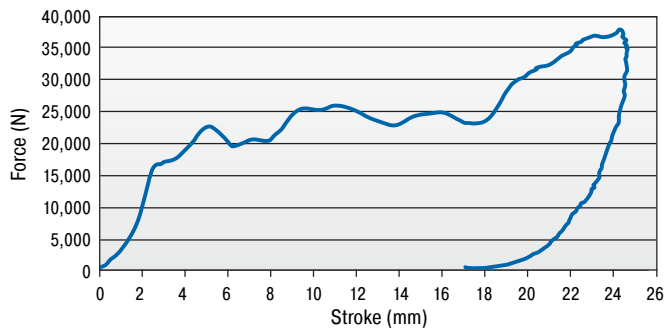

|                  |        |
|------------------|--------|
|                  | TI16   |
| Total energy:    | 562 Nm |
| Absorbed energy: | 511 Nm |
| Efficiency:      | 91 %   |

### Force-Stroke TI24, TI30 and TI36

Dynamic trials on a drop test rig

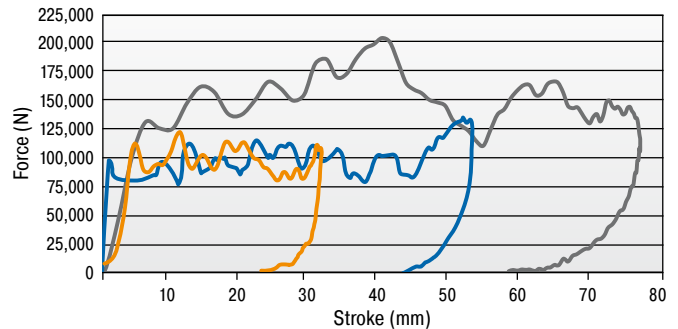

|                  |           |          |          |
|------------------|-----------|----------|----------|
|                  | TI36      | TI30     | TI24     |
| Total energy:    | 10,954 Nm | 4,510 Nm | 2,701 Nm |
| Absorbed energy: | 10,513 Nm | 4,309 Nm | 2,545 Nm |
| Efficiency:      | 96 %      | 96 %     | 94 %     |

The characteristic values have been established under dynamic load.

The calculation and selection of the most suitable damper should be carried out or be approved by ACE.

### Ordering Example

TUBUS Irreversible \_\_\_\_\_ ↑  
 Thread Size M16 \_\_\_\_\_ ↑  
 Stroke 25 mm \_\_\_\_\_ ↑  
 Number of Bellows \_\_\_\_\_ ↑

**TI16-25-1**

## Performance and Dimensions

| TYPES     | Energy capacity emergency use Nm/cycle | Stroke max. mm | Reacting Force N | A mm | d1 mm | d2 mm | L <sub>M</sub> mm | M       | Depth thread hole min. mm | Weight kg |
|-----------|--|----------------|------------------|------|-------|-------|-------------------|---------|---------------------------|-----------|
| TI16-25-1 | 562                                    | 25             | 37,138           | 48   | 32    | 38    | 15                | M16x2   | 25                        | 0.045     |
| TI24-33-1 | 2,701                                  | 33             | 113,590          | 64.5 | 50    | 50    | 40                | M24x3   | 40                        | 0.140     |
| TI30-52-2 | 4,510                                  | 52             | 121,130          | 113  | 50    | 50    | 57                | M30x3.5 | 63                        | 0.240     |
| TI36-80-3 | 10,953                                 | 80             | 204,127          | 172  | 63    | 65    | 89                | M36x4   | 89                        | 0.620     |

# Clamping Elements

## On-the-spot clamping and stopping in emergencies and other situations

Clamping elements from the LOCKED series also serve the purpose of safety. These ACE products clamp and decelerate loads and are suitable for perfectly controlled holding, both linear and rotary, in all processes.

Alongside ACE LOCKED solutions for conventional rail, rod or rotation clamping, special clamps with safety function for Z-axes, which reliably help secure axes with a gravitational load, are available in the LOCKED LZ-P series. The latter solution is available for both pneumatic operation and as an electric version. Whether Z-axes, linear guide, rod or rotation clamping, the choice is (typical of ACE) as large as the performance capacity of the products, which are compatible with the solutions of all standard manufacturers.



**LOCKED by ACE. After all, safe is safe.**

**Increased process reliability**

**Available as clamping and emergency stop brakes**

**Very short stop distances**

**Very high clamping forces**

**Compact designs**

**Ideal for all standard sizes**



## Rail Clamping

### For safe deceleration of rail-guided construction elements

Safe deceleration of a mass that is traversed with the help of a rail and guide rail and track carriage combination must be complied with and not only for safety reasons; reliable clamps in the production processes are also becoming increasingly important.

Both features can be taken care of by the clamping elements from ACE. All clamping elements work with the patented spring steel plate system.

This system achieves braking and clamping forces of up to 10,000 N. The clamping elements are always individually adapted to the used linear guide. They are available for all rail sizes and profiles for all renowned manufacturers.

### Function of clamping elements LOCKED PL/SL/PLK/SLK

All process and safety clamps work with the reinforced spring steel plate system.

Compressed air is introduced between the two spring plates, which are connected with a surrounding rubber coating.

If pressure is applied, the clamping element can freely move; if the clamping element is vented clamping to the guide rail follows.

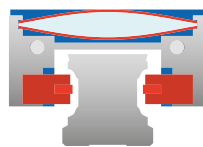

Clamping element ventilated

#### Released

The chamber filled with compressed air between the spring steel plates relaxes and thus releases the clamping/brake pads from the rail. The clamping element is now free to move.

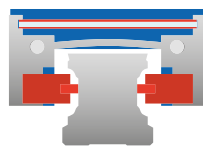

Clamping element vented

#### Engaged

The clamping force of the mechanically pre-stressed spring steel plates is transferred to the clamping/brake pads as holding force. The clamping element is clamped on the guide rail.

### Slot dimensions between braking and clamping linings and linear guide rail

The internal dimension "I" between the linings of every LOCKED rail clamping is ground to an exact value.

This is always 0.01 to 0.03 mm greater than the upper limit J max. of the respective linear guide rail (see drawing), resulting from the manufacturer's directives.

The maximum holding force results at J max. and, in the most unfavorable case, holding force losses up to 30 % can occur (see table).

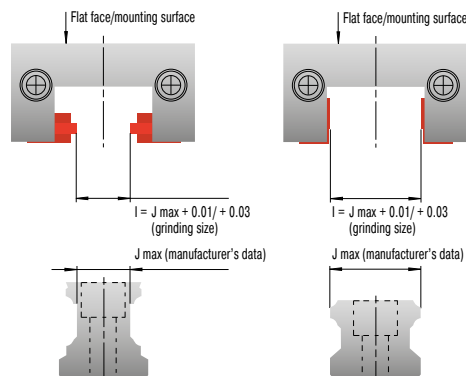

| Air Gap<br>Lining/Linear Guide Rail<br>mm | Loss in Holding<br>Force<br>% |
|---|-------------------------------|
| 0.01                                      | 5                             |
| 0.03                                      | 10                            |
| 0.05                                      | 20                            |
| 0.07                                      | 30                            |

### Different brake pads for PL/PLK and for SL/SLK

The process clamps and safety clamps are available completely identical in their structure.

They differ only in the clamping and brake pads material.



Clamping

#### Position Clamping

The types of the LOCKED series PL and PLK are designed for clamping directly on the linear guide. The clamping linings are produced from tool steel and offer 100 % clamping force, even in the case of lubricated rails.



Braking

#### Position Clamping and Emergency Stop Braking

With the typical SL, SLK, low-wear sinter graphite linings are employed. These enable both a position clamping, as well as emergency stop braking on the linear guide. In case of lubricated rails, a stopping force of 60 % of the nominal stopping force should be considered.

## Rod Clamping

### The modular solution for exact holding at certain positions

Safe and reliable stopping at a position or an operating state is an important part of many production processes. This task can be performed by the clamping elements from ACE. If clamping on a rod is required, the clamping elements of the PN and PRK families are the right choice.

Thanks to the patented spring steel plate system the rod clamps transfer clamping forces of up to 36,000 N directly to the (piston) rod.

The PN and PRK rod clamps can absorb both axial and rotary forces.

### Function of clamping elements LOCKED PN and PRK

Consisting of a deck plate, one to four clamping units and a base plate, all rod clamps work with the reinforced spring steel plate system.

Through that, both axial and rotary forces can be absorbed.

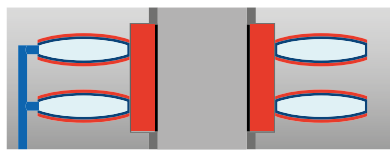

Clamping element is released

#### Released

The membrane filled with compressed air relaxes the spring steel plate system and releases the clamping sleeve.

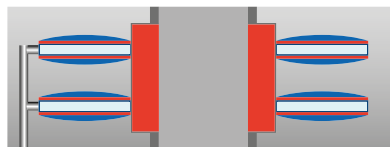

Clamping element is engaged

#### Engaged

The clamping force of the mechanically pre-stressed spring steel plates system is transferred as a holding force into the clamping sleeve. The rod or shaft is engaged.

### Intelligent component system solution

By connecting up to four clamping units between the base and deck plates, it is possible to easily increase the clamping force.

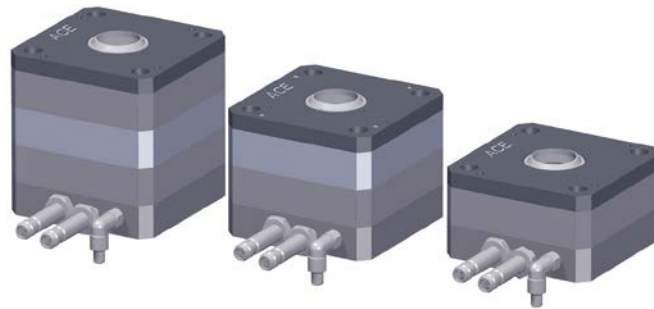

Modular construction

### Component tolerances for LOCKED PN and PRK

Design-related, the addition of the individual component tolerances leads to an elastic axial tolerance allowance. This axial tolerance allowance can be up to 500 µm in the clamped status, according to implementation!

The axis/shaft/rod must be machined with at least h9-fit (or better) above h5. Deviations from the prescribed tolerance can lead to reduction of the stopping force, or functional failure.



Rod clamping



## Rotational Clamping

### The reliable protection against twisting

Reliable holding and securing against a rotation of a position are important elements in many production processes.

This task can be performed by means of the clamping elements of the Locked R family. The rotational clamps can, thanks to the patented spring steel plate system, transfer holding torques of up to 4,680 Nm to the shaft.

The spring accumulator can immediately clamp the axis during a power failure.

### Function of clamping elements LOCKED R

The reinforced spring steel plate system transfers holding torques in the shortest possible time.



Clamping element is released

#### Released

The membrane filled with compressed air relaxes the spring steel plate system and releases the clamping ring. The shaft is free to move.



Clamping element is engaged

#### Engaged

The clamping force of the membrane/spring steel plates systems is transferred to the holding force of the clamping ring. The shaft is clamped.

### Function of clamping elements LOCKED R-Z with additional air

If higher holding torques are required, the rotational clamps with an additional air function are used.

With the same size, significantly higher holding torques are achieved.



Increased clamping force with additional air

#### Engaged with additional air

By filling the outer membrane chamber with additional compressed air (4 or 6 bar), there is the possibility to increase the clamping force. The clamping element is engaged in this condition.

## Clamping Elements



### LOCKED PL

Page 280

Process Clamping for Rail Systems  
**High clamping power for all rail profiles**  
 Tool machines, Transport systems, Feeder installations,  
 Positioning tables



### LOCKED PLK

Page 282

Process Clamping for Rail Systems, Compact  
**High clamping power for all compact design rail profiles**  
 Tool machines, Transport systems, Feeder installations,  
 Positioning tables



### LOCKED SL

Page 284

Safety Clamping for Rail Systems  
**Combined clamping and braking**  
 Tool machines, Transport systems, Feeder installations,  
 Positioning tables



### LOCKED SLK

Page 286

Safety Clamping for Rail Systems, Compact  
**Combined compact design clamping and braking**  
 Tool machines, Transport systems, Feeder installations,  
 Positioning tables



### LOCKED LZ-P

Page 288

Rail Clamping for Z-Axes  
**Certified safety clamping**  
 Z-axes, Vertical conveyor systems, Jacking applications



### LOCKED PN

Page 290

Pneumatic Rod Clamping  
**Rod clamping with maximum clamping force**  
 Jacking systems, Light presses, Punching/stamping machines,  
 Stacking units



### LOCKED PRK

Page 292

Pneumatic Rod Clamping, Compact  
**Rod clamping with maximum clamping force in a compact size**  
 Jacking systems, Light presses, Punching/stamping machines,  
 Stacking units



### LOCKED R

Page 294

Pneumatic Rotational Clamping  
**Strong holding force on the shaft**  
 Drive shafts, Torque motors, Conveyor systems

## LOCKED PL

### High clamping power for all rail profiles

#### Process Clamping for Rail Systems Holding forces 540 N to 10,000 N

Always on the safe side: LOCKED PL process clamping elements clamp directly onto the clear area of guide rails on linear modules with forces of up to 10,000 N. They are individually adjusted to the linear guide being used and are available for all rail sizes from 20 mm to 65 mm and profiles from all renowned manufacturers.

This product family achieves 100 % clamping force even on greased rails, due to the steel pads that are used. It offers optimum static clamping with up to 1 million cycles. These process clamping elements also impress with their low system costs in comparison with hydraulic and electric solutions.

The various LOCKED PL models from ACE are mainly used on machine tools and customised machines.

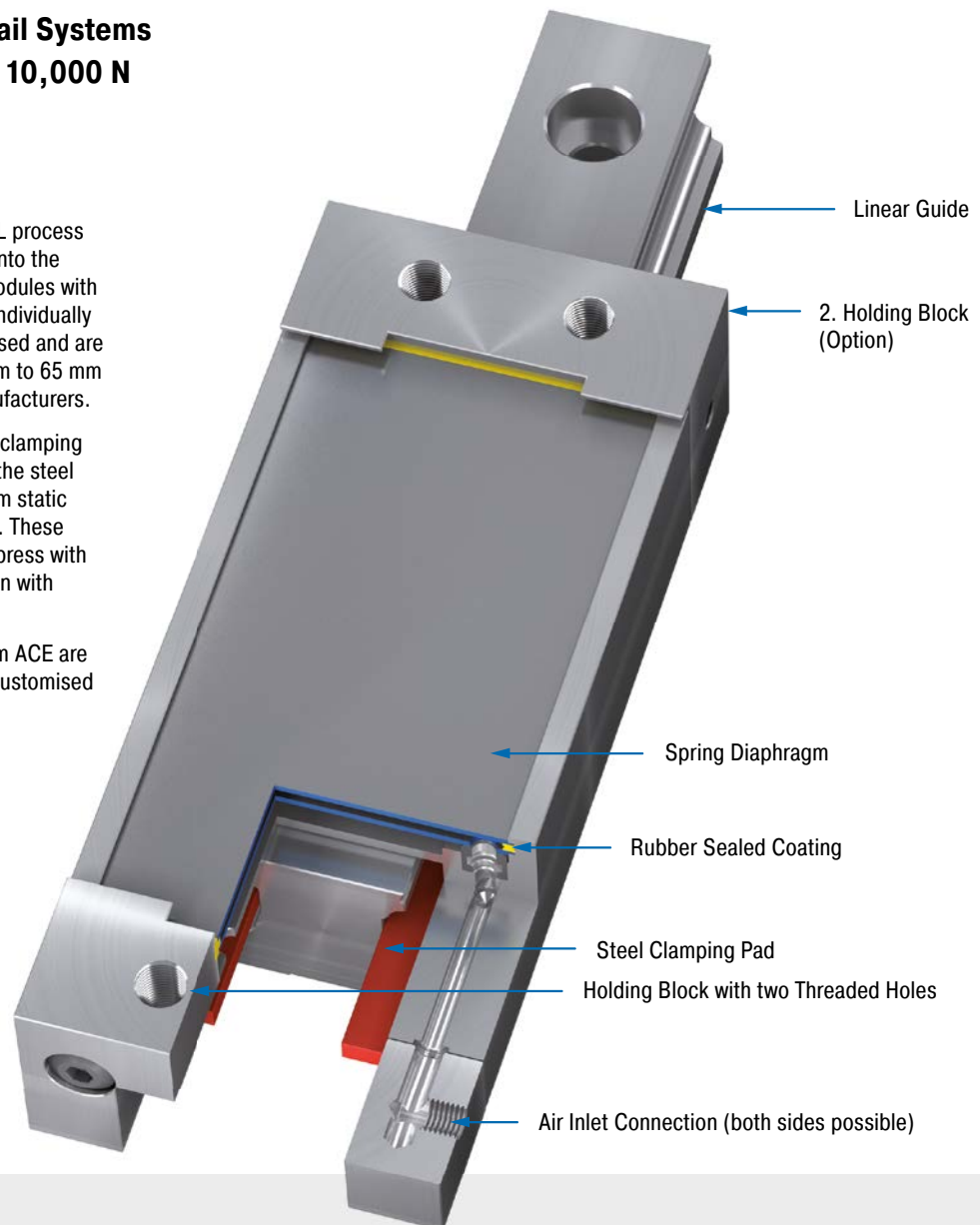

#### Technical Data

**Holding forces:** 540 N to 10,000 N

**Rail sizes:** 20 mm to 65 mm

**Clamping cycles:** 1,000,000

**Mounting:** In any position

**Operating pressure:** 4 bar (automotive) or 6 bar

**Material:** Outer body: Tool steel

**Pneumatic medium:** Dried, filtered air

**Operating temperature range:** 15 °C to 45 °C

**Application field:** Tool machines, Transport systems, Feeder installations, Positioning tables, Assembly stations

**Note:** If requested installation drawings of the respective types are provided.

**On request:** Special designs on request.

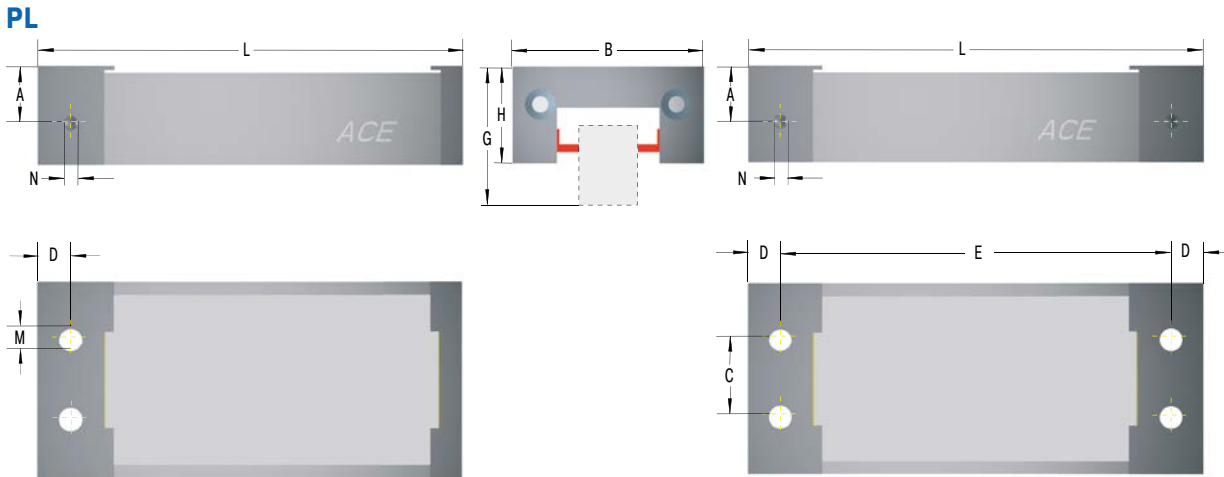

The calculation and selection of the most suitable clamping element should be carried out or be approved by ACE.

### Complete details required when ordering

- Operating pressure: 4 bar or 6 bar
- Number of holding blocks
- Rail manufacturer, rail type, rail size
- Carriage type name
- Number of clamping cycles per hour

### Ordering Example

Linear Process Clamping **PL45-2-6B-X**  
 Rail Nominal Size 45 mm  
 Number of Holding Blocks 2  
 6B = 6 bar Type  
 4B = 4 bar Type  
 Series Number assigned by ACE

### Performance and Dimensions

| TYPES     | Holding force<br>N | Operating<br>pressure<br>bar | Low Carriage |         |         |         |         | High Carriage |         |         | M    | N   | Weight<br>kg |     |      |      |
|-----------|--------------------|------------------------------|--------------|---------|---------|---------|---------|---------------|---------|---------|------|-----|--------------|-----|------|------|
|           |                    |                              | B<br>mm      | C<br>mm | D<br>mm | E<br>mm | L<br>mm | A<br>mm       | G<br>mm | H<br>mm |      |     |              |     |      |      |
| PL20-1-4B | 540                | 4                            | 43           | 12      | 6       | -       | 97.5    | 13.5          | 30      | 19.5    | -    | -   | -            | M5  | M5   | 0.32 |
| PL20-1-6B | 900                | 6                            | 43           | 12      | 6       | -       | 97.5    | 13.5          | 30      | 19.5    | -    | -   | -            | M5  | M5   | 0.32 |
| PL25-1-4B | 780                | 4                            | 47           | 16      | 6       | -       | 117.5   | 15.5          | 36      | 25      | 19.5 | 40  | 29           | M6  | M5   | 0.50 |
| PL25-1-6B | 1,200              | 6                            | 47           | 16      | 6       | -       | 117.5   | 15.5          | 36      | 25      | 19.5 | 40  | 29           | M6  | M5   | 0.50 |
| PL30-1-4B | 1,100              | 4                            | 59           | 18      | 10      | -       | 126.5   | 17.0          | 42      | 29.5    | 20.0 | 45  | 32.5         | M8  | M5   | 0.90 |
| PL30-1-6B | 1,800              | 6                            | 59           | 18      | 10      | -       | 126.5   | 17.0          | 42      | 29.5    | 20.0 | 45  | 32.5         | M8  | M5   | 0.90 |
| PL35-1-4B | 1,800              | 4                            | 69           | 22      | 10      | -       | 156.5   | 22.5          | 48      | 35      | 29.5 | 55  | 42           | M10 | G1/8 | 1.26 |
| PL35-1-6B | 2,800              | 6                            | 69           | 22      | 10      | -       | 156.5   | 22.5          | 48      | 35      | 29.5 | 55  | 42           | M10 | G1/8 | 1.26 |
| PL45-1-4B | 2,400              | 4                            | 80           | 28      | 10      | -       | 176.5   | 26.5          | 60      | 42      | 36.5 | 70  | 52           | M10 | G1/8 | 2.30 |
| PL45-1-6B | 4,000              | 6                            | 80           | 28      | 10      | -       | 176.5   | 26.5          | 60      | 42      | 36.5 | 70  | 52           | M10 | G1/8 | 2.30 |
| PL45-2-4B | 2,400              | 4                            | 80           | 28      | 10      | 171.2   | 191.5   | 26.5          | 60      | 42      | 36.5 | 70  | 52           | M10 | G1/8 | 2.30 |
| PL45-2-6B | 4,000              | 6                            | 80           | 28      | 10      | 171.2   | 191.5   | 26.5          | 60      | 42      | 36.5 | 70  | 52           | M10 | G1/8 | 2.30 |
| PL55-1-4B | 3,600              | 4                            | 98           | 34      | 12.5    | -       | 202.5   | 28.0          | 70      | 49      | 38.0 | 80  | 59           | M10 | G1/8 | 3.90 |
| PL55-1-6B | 6,000              | 6                            | 98           | 34      | 12.5    | -       | 202.5   | 28.0          | 70      | 49      | 38.0 | 80  | 59           | M10 | G1/8 | 3.90 |
| PL55-2-4B | 3,600              | 4                            | 98           | 34      | 12.5    | 196.2   | 221.5   | 28.0          | 70      | 49      | 38.0 | 80  | 59           | M10 | G1/8 | 4.10 |
| PL55-2-6B | 6,000              | 6                            | 98           | 34      | 12.5    | 196.2   | 221.5   | 28.0          | 70      | 49      | 38.0 | 80  | 59           | M10 | G1/8 | 4.10 |
| PL65-1-4B | 6,000              | 4                            | 120          | 44      | 15      | -       | 259.5   | 38.0          | 90      | 64      | 48.0 | 100 | 74           | M12 | G1/8 | 5.00 |
| PL65-1-6B | 10,000             | 6                            | 120          | 44      | 15      | -       | 259.5   | 38.0          | 90      | 64      | 48.0 | 100 | 74           | M12 | G1/8 | 5.00 |
| PL65-2-4B | 6,000              | 4                            | 120          | 44      | 15      | 251.5   | 281.5   | 38.0          | 90      | 64      | 48.0 | 100 | 74           | M12 | G1/8 | 5.20 |
| PL65-2-6B | 10,000             | 6                            | 120          | 44      | 15      | 251.5   | 281.5   | 38.0          | 90      | 64      | 48.0 | 100 | 74           | M12 | G1/8 | 5.20 |

<sup>1</sup> The holding forces as shown in the capacity chart were determined on dry rails for roller systems (STAR, INA). Different holding forces may occur for other rails.

## LOCKED PLK

High clamping power for all compact design rail profiles

**Process Clamping for Rail Systems, Compact**  
**Holding forces 300 N to 2,100 N**

Small can clamp perfectly too: The LOCKED-Family PLK clamping elements are more compact than the Series PL components. They also clamp directly onto the respective linear guide, suit all standard rail sizes from 15 mm to 55 mm and profiles from the known suppliers and are extremely reliable and space-saving.

Thanks to the patented spring steel plate system, the LOCKED-Family PLK achieves clamping and holding forces of up to 2,100 N with the shortest reaction times when vented. LOCKED PLK achieve 100 % clamping force due to the steel pads that are used, even on greased rails. The clamping elements represent the maximum holding forces. Whether in the 4 or 6 bar version, they are good for up to 1 million cycles.

LOCKED PLK clamping elements from ACE are primarily used in mechanical engineering and customised machines.

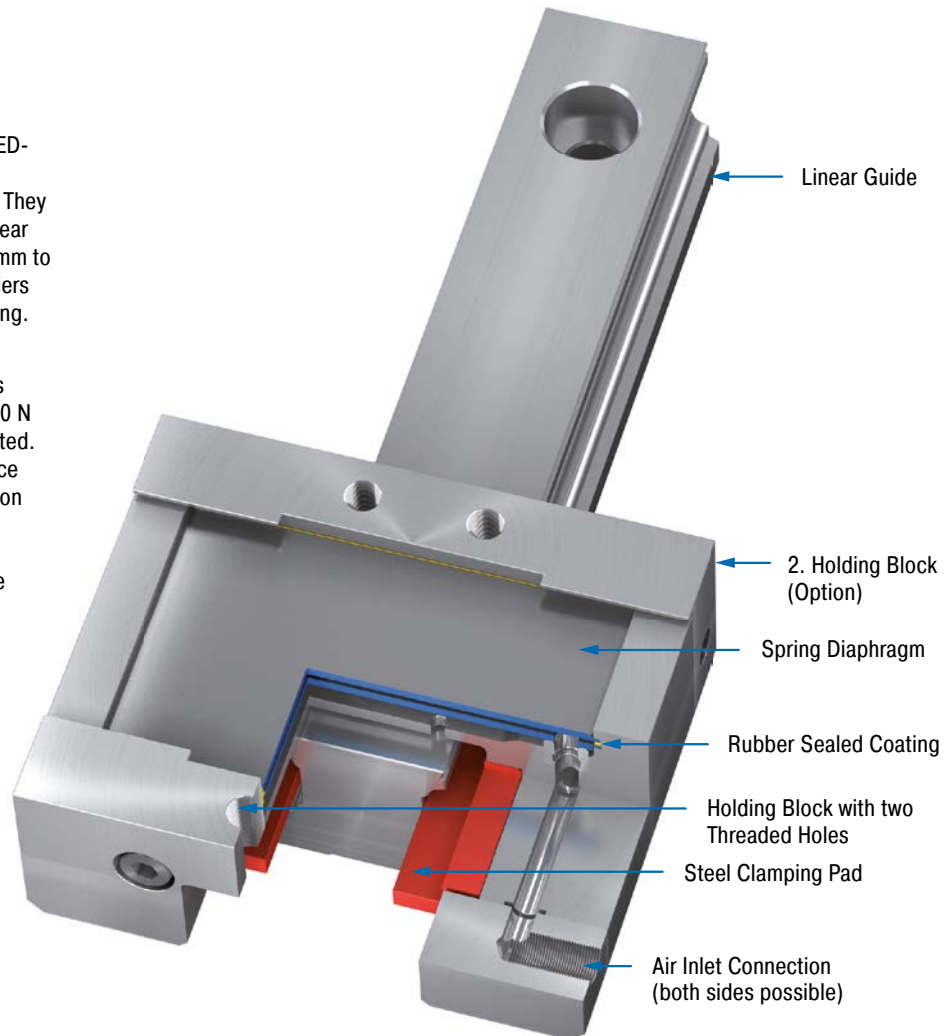

### Technical Data

**Holding forces:** 300 N to 2,100 N

**Rail sizes:** 15 mm to 55 mm

**Clamping cycles:** 1,000,000

**Mounting:** In any position

**Operating pressure:** 4 bar (automotive) or 6 bar

**Material:** Outer body: Tool steel

**Pneumatic medium:** Dried, filtered air

**Operating temperature range:** 15 °C to 45 °C

**Application field:** Tool machines, Transport systems, Feeder installations, Positioning tables, Assembly stations

**Note:** If requested installation drawings of the respective types are provided.

**On request:** Special designs on request.

### PLK

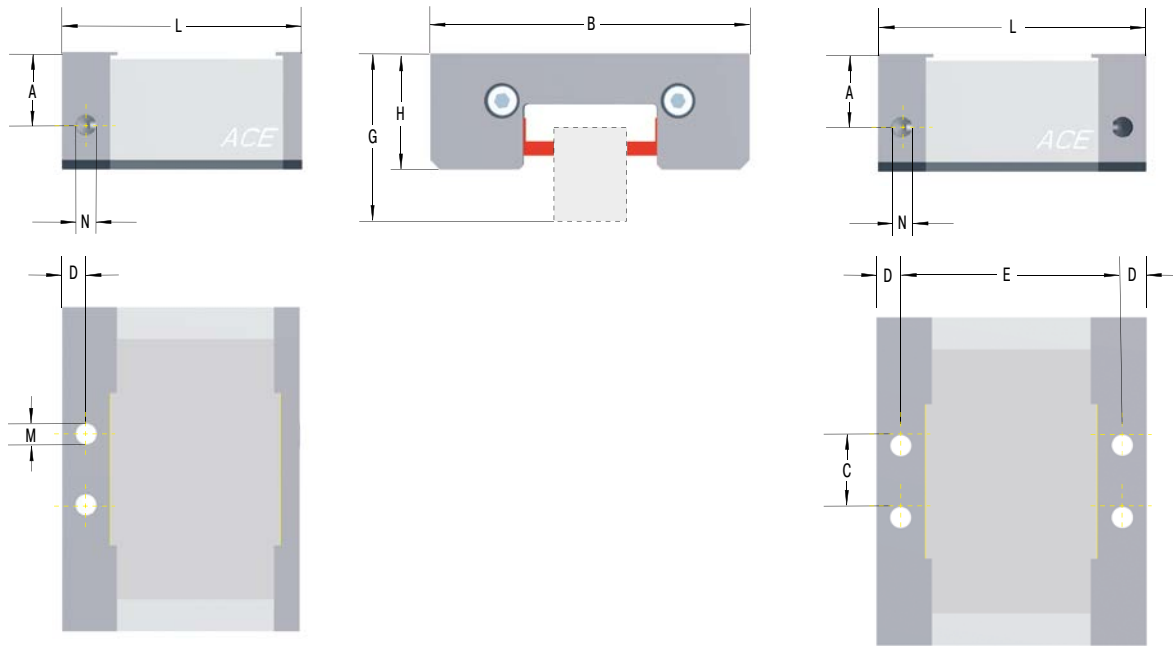

The calculation and selection of the most suitable clamping element should be carried out or be approved by ACE.

### Complete details required when ordering

Operating pressure: 4 bar or 6 bar  
 Number of holding blocks  
 Rail manufacturer, rail type, rail size  
 Carriage type name  
 Number of clamping cycles per hour

### Ordering Example

Linear Process Clamping Compact \_\_\_\_\_  
 Rail Nominal Size 55 mm \_\_\_\_\_  
 Number of Holding Blocks 2 \_\_\_\_\_  
 6B = 6 bar Type \_\_\_\_\_  
 4B = 4 bar Type \_\_\_\_\_  
 Series Number assigned by ACE \_\_\_\_\_

**PLK55-2-6B-X**

### Performance and Dimensions

| TYPES      | Holding force<br>N | Operating<br>pressure<br>bar | Low Carriage |         |         |         |         | High Carriage |         |         | M    | N  | Weight<br>kg |     |      |      |
|------------|--------------------|------------------------------|--------------|---------|---------|---------|---------|---------------|---------|---------|------|----|--------------|-----|------|------|
|            |                    |                              | B<br>mm      | C<br>mm | D<br>mm | E<br>mm | L<br>mm | A<br>mm       | G<br>mm | H<br>mm |      |    |              |     |      |      |
| PLK15-1-4B | 300                | 4                            | 45           | 12      | 5       | -       | 55.5    | 14.0          | 24      | 18      | 14.0 | -  | -            | M5  | M5   | 0.50 |
| PLK15-1-6B | 450                | 6                            | 45           | 12      | 5       | -       | 55.5    | 14.0          | 24      | 18      | 14.0 | -  | -            | M5  | M5   | 0.50 |
| PLK20-1-4B | 430                | 4                            | 54           | 16      | 5       | -       | 55.5    | 16.0          | 30      | 22      | 16.0 | -  | -            | M6  | M5   | 0.60 |
| PLK20-1-6B | 650                | 6                            | 54           | 16      | 5       | -       | 55.5    | 16.0          | 30      | 22      | 16.0 | -  | -            | M6  | M5   | 0.60 |
| PLK25-1-4B | 530                | 4                            | 75           | 16      | 5       | -       | 55.5    | 16.0          | 36      | 25.5    | 16.0 | 40 | 29.5         | M6  | M5   | 0.70 |
| PLK25-1-6B | 800                | 6                            | 75           | 16      | 5       | -       | 55.5    | 16.0          | 36      | 25.5    | 16.0 | 40 | 29.5         | M6  | M5   | 0.70 |
| PLK30-1-4B | 750                | 4                            | 89           | 18      | 8.75    | -       | 67      | 21.0          | 42      | 30      | 21.0 | 45 | 33           | M8  | M5   | 0.90 |
| PLK30-1-6B | 1,150              | 6                            | 89           | 18      | 8.75    | -       | 67      | 21.0          | 42      | 30      | 21.0 | 45 | 33           | M8  | M5   | 0.90 |
| PLK35-1-4B | 820                | 4                            | 96           | 22      | 8.75    | -       | 67      | 21.2          | 48      | 35      | 21.2 | 55 | 42           | M10 | G1/8 | 1.27 |
| PLK35-1-6B | 1,250              | 6                            | 96           | 22      | 8.75    | -       | 67      | 21.2          | 48      | 35      | 21.2 | 55 | 42           | M10 | G1/8 | 1.27 |
| PLK45-1-4B | 950                | 4                            | 116          | 28      | 10      | -       | 80      | 27.5          | 60      | 45      | 27.5 | 70 | 55           | M10 | G1/8 | 2.00 |
| PLK45-1-6B | 1,500              | 6                            | 116          | 28      | 10      | -       | 80      | 27.5          | 60      | 45      | 27.5 | 70 | 55           | M10 | G1/8 | 2.00 |
| PLK45-2-4B | 950                | 4                            | 116          | 28      | 10      | 72      | 92      | 27.5          | 60      | 45      | 27.5 | 70 | 55           | M10 | G1/8 | 2.20 |
| PLK45-2-6B | 1,500              | 6                            | 116          | 28      | 10      | 72      | 92      | 27.5          | 60      | 45      | 27.5 | 70 | 55           | M10 | G1/8 | 2.20 |
| PLK55-1-4B | 1,300              | 4                            | 136          | 34      | 10      | -       | 100     | 30.5          | 70      | 49      | 30.5 | 80 | 59           | M10 | G1/8 | 2.80 |
| PLK55-1-6B | 2,100              | 6                            | 136          | 34      | 10      | -       | 100     | 30.5          | 70      | 49      | 30.5 | 80 | 59           | M10 | G1/8 | 2.80 |
| PLK55-2-4B | 1,300              | 4                            | 136          | 34      | 10      | 92      | 112     | 30.5          | 70      | 49      | 30.5 | 80 | 59           | M10 | G1/8 | 3.00 |
| PLK55-2-6B | 2,100              | 6                            | 136          | 34      | 10      | 92      | 112     | 30.5          | 70      | 49      | 30.5 | 80 | 59           | M10 | G1/8 | 3.00 |

<sup>1</sup> The holding forces as shown in the capacity chart were determined on dry rails for roller systems (STAR, INA). Different holding forces may occur for other rails.



# LOCKED SL

## Combined clamping and braking

### Safety Clamping for Rail Systems Holding forces 540 N to 10,000 N

Always on the safe side: The safety clamping elements LOCKED SL clamp and brake directly on the clear area of guide rails on linear modules with forces of up to 10,000 N. They are individually adjusted to the linear guide being used and are available for all rail sizes from 20 mm to 65 mm and profiles from all renowned manufacturers.

Special brake pads made of low wear sintered metal are used for the additional emergency stop braking functions in the safety clamping elements

LOCKED SL. The SL product family offers optimum static clamping with a service life up to 1 million cycles or up to 500 emergency braking operations. They also offer low system costs in comparison with hydraulic and electric solutions.

Anwender nutzen die LOCKED SL besonders im Maschinen- und Sondermaschinenbau.

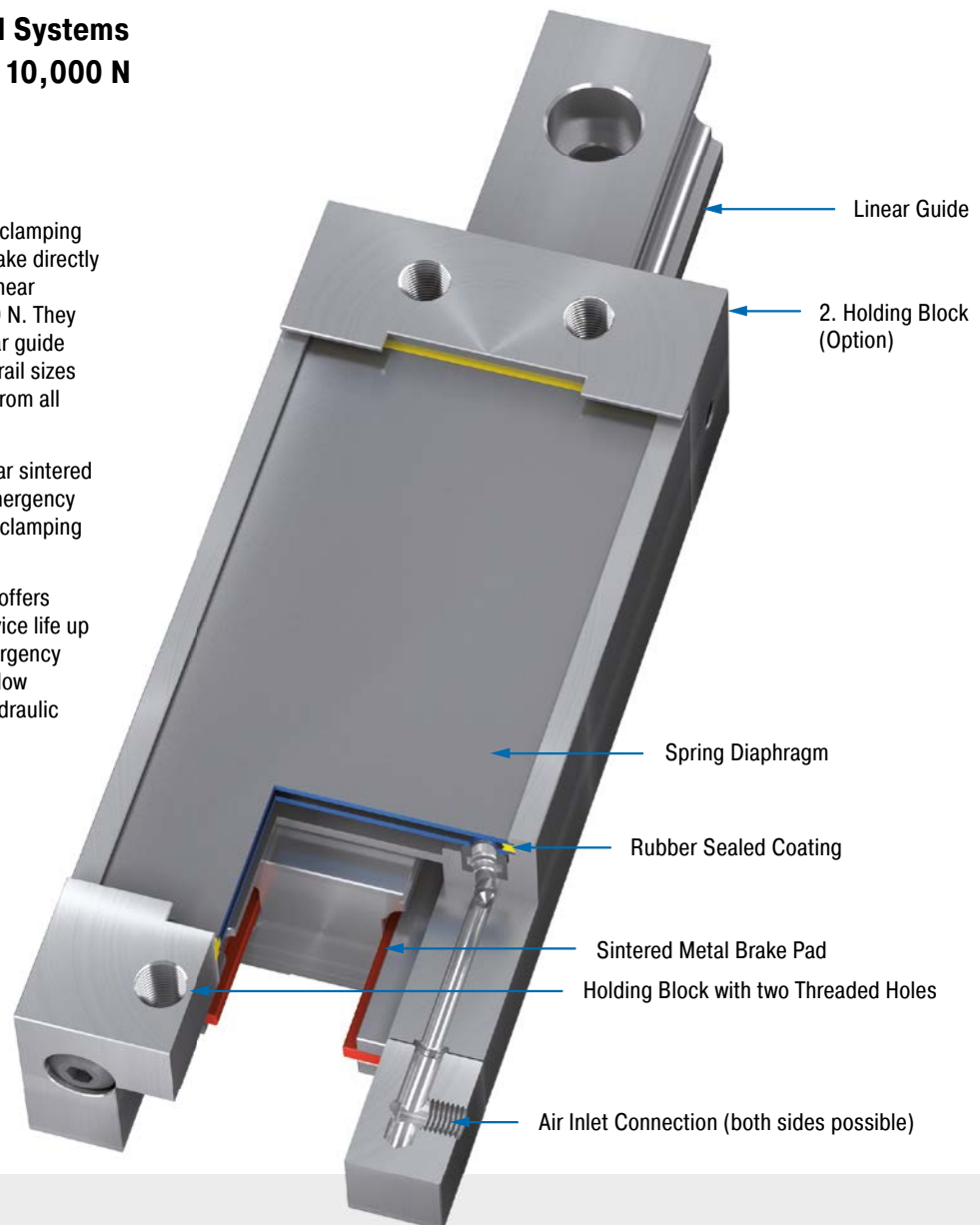

### Technical Data

**Holding forces:** 540 N to 10,000 N

**Rail sizes:** 20 mm to 65 mm

**Clamping cycles/emergency use:** 500

**Clamping cycles:** 1,000,000

**Mounting:** In any position

**Operating pressure:** 4 bar (automotive) or 6 bar

**Material:** Outer body: Tool steel; Brake components: Sintered graphite

**Pneumatic medium:** Dried, filtered air

**Operating temperature range:** 15 °C to 45 °C

**Application field:** Tool machines, Transport systems, Feeder installations, Positioning tables, Assembly stations

**Note:** If requested installation drawings of the respective types are provided.

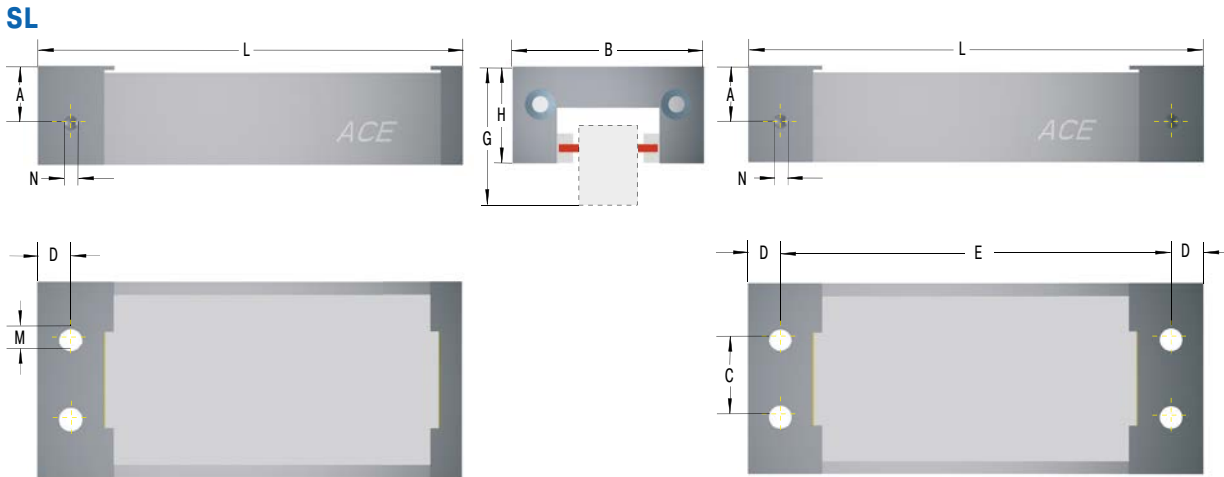

The calculation and selection of the most suitable clamping element should be carried out or be approved by ACE.

### Complete details required when ordering

- Operating pressure: 4 bar or 6 bar
- Number of holding blocks
- Rail manufacturer, rail type, rail size
- Carriage type name
- Number of clamping cycles per hour

### Ordering Example

Linear Safety Clamping **SL55-1-4B-X**  
 Rail Nominal Size 55 mm  
 Number of Holding Blocks 1  
 4B = 4 bar Type  
 6B = 6 bar Type  
 Series Number assigned by ACE

### Performance and Dimensions

| TYPES     | Holding force<br>N | Operating<br>pressure<br>bar | B<br>mm | C<br>mm | D<br>mm | E<br>mm | L<br>mm | Low Carriage |         |         | High Carriage |         |         | M   | N    | Weight<br>kg |
|-----------|--------------------|------------------------------|---------|---------|---------|---------|---------|--------------|---------|---------|---------------|---------|---------|-----|------|--------------|
|           |                    |                              |         |         |         |         |         | A<br>mm      | G<br>mm | H<br>mm | A<br>mm       | G<br>mm | H<br>mm |     |      |              |
| SL20-1-4B | 540                | 4                            | 43      | 12      | 6       | -       | 97.5    | 13.5         | 30      | 19.5    | -             | -       | -       | M5  | M5   | 0.32         |
| SL20-1-6B | 900                | 6                            | 43      | 12      | 6       | -       | 97.5    | 13.5         | 30      | 19.5    | -             | -       | -       | M5  | M5   | 0.32         |
| SL25-1-4B | 780                | 4                            | 47      | 16      | 6       | -       | 117.5   | 15.5         | 36      | 25      | 19.5          | 40      | 29      | M6  | M5   | 0.50         |
| SL25-1-6B | 1,200              | 6                            | 47      | 16      | 6       | -       | 117.5   | 15.5         | 36      | 25      | 19.5          | 40      | 29      | M6  | M5   | 0.50         |
| SL30-1-4B | 1,100              | 4                            | 59      | 18      | 10      | -       | 126.5   | 17.0         | 42      | 29.5    | 20.0          | 45      | 32.5    | M8  | M5   | 0.90         |
| SL30-1-6B | 1,800              | 6                            | 59      | 18      | 10      | -       | 126.5   | 17.0         | 42      | 29.5    | 20.0          | 45      | 32.5    | M8  | M5   | 0.90         |
| SL35-1-4B | 1,800              | 4                            | 69      | 22      | 10      | -       | 156.5   | 22.5         | 48      | 35      | 29.5          | 55      | 42      | M10 | G1/8 | 1.26         |
| SL35-1-6B | 2,800              | 6                            | 69      | 22      | 10      | -       | 156.5   | 22.5         | 48      | 35      | 29.5          | 55      | 42      | M10 | G1/8 | 1.26         |
| SL45-1-4B | 2,400              | 4                            | 80      | 28      | 10      | -       | 176.5   | 26.5         | 60      | 42      | 36.5          | 70      | 52      | M10 | G1/8 | 2.30         |
| SL45-1-6B | 4,000              | 6                            | 80      | 28      | 10      | -       | 176.5   | 26.5         | 60      | 42      | 36.5          | 70      | 52      | M10 | G1/8 | 2.30         |
| SL45-2-4B | 2,400              | 4                            | 80      | 28      | 10      | 171.2   | 191.5   | 26.5         | 60      | 42      | 36.5          | 70      | 52      | M10 | G1/8 | 2.30         |
| SL45-2-6B | 4,000              | 6                            | 80      | 28      | 10      | 171.2   | 191.5   | 26.5         | 60      | 42      | 36.5          | 70      | 52      | M10 | G1/8 | 2.30         |
| SL55-1-4B | 3,600              | 4                            | 98      | 34      | 12.5    | -       | 202.5   | 28.0         | 70      | 49      | 38.0          | 80      | 59      | M10 | G1/8 | 3.90         |
| SL55-1-6B | 6,000              | 6                            | 98      | 34      | 12.5    | -       | 202.5   | 28.0         | 70      | 49      | 38.0          | 80      | 59      | M10 | G1/8 | 3.90         |
| SL55-2-4B | 3,600              | 4                            | 98      | 34      | 12.5    | 196.2   | 221.5   | 28.0         | 70      | 49      | 38.0          | 80      | 59      | M10 | G1/8 | 3.90         |
| SL55-2-6B | 6,000              | 6                            | 98      | 34      | 12.5    | 196.2   | 221.5   | 28.0         | 70      | 49      | 38.0          | 80      | 59      | M10 | G1/8 | 3.90         |
| SL65-1-4B | 6,000              | 4                            | 120     | 44      | 15      | -       | 259.5   | 38.0         | 90      | 64      | 48.0          | 100     | 74      | M12 | G1/8 | 5.00         |
| SL65-1-6B | 10,000             | 6                            | 120     | 44      | 15      | -       | 259.5   | 38.0         | 90      | 64      | 48.0          | 100     | 74      | M12 | G1/8 | 5.00         |
| SL65-2-4B | 6,000              | 4                            | 120     | 44      | 15      | 251.2   | 281.5   | 38.0         | 90      | 64      | 48.0          | 100     | 74      | M12 | G1/8 | 5.20         |
| SL65-2-6B | 10,000             | 6                            | 120     | 44      | 15      | 251.2   | 281.5   | 38.0         | 90      | 64      | 48.0          | 100     | 74      | M12 | G1/8 | 5.20         |

<sup>1</sup> The holding forces as shown in the capacity chart were determined on dry rails for roller systems (STAR, INA). Different holding forces may occur for other rails.

# LOCKED SLK

## Combined compact design clamping and braking

### Safety Clamping for Rail Systems, Compact Holding forces 300 N to 2,100 N

Small can clamp perfectly too: The LOCKED-Family SLK clamping elements are more compact than the Series SL. They also clamp directly onto the respective linear guide, suit all standard rail sizes from 15 mm to 55 mm and profiles from the known suppliers and are extremely reliable and safe.

Thanks to the patented spring steel plate system, the product family SLK achieves clamping and holding forces of up to 2,100 N with the shortest reaction times when vented. Thanks to the sintered metal coatings and the clamping function in emergency stop (e.g. in case of a power failure), this range enables braking directly on the rail. All clamping elements offer the maximum holding and braking forces and achieve up to 1 million clamping cycles or up to a maximum of 500 emergency braking operations in the 4 and 6 bar version.

LOCKED SLK are used in mechanical engineering and customised mechanical engineering.

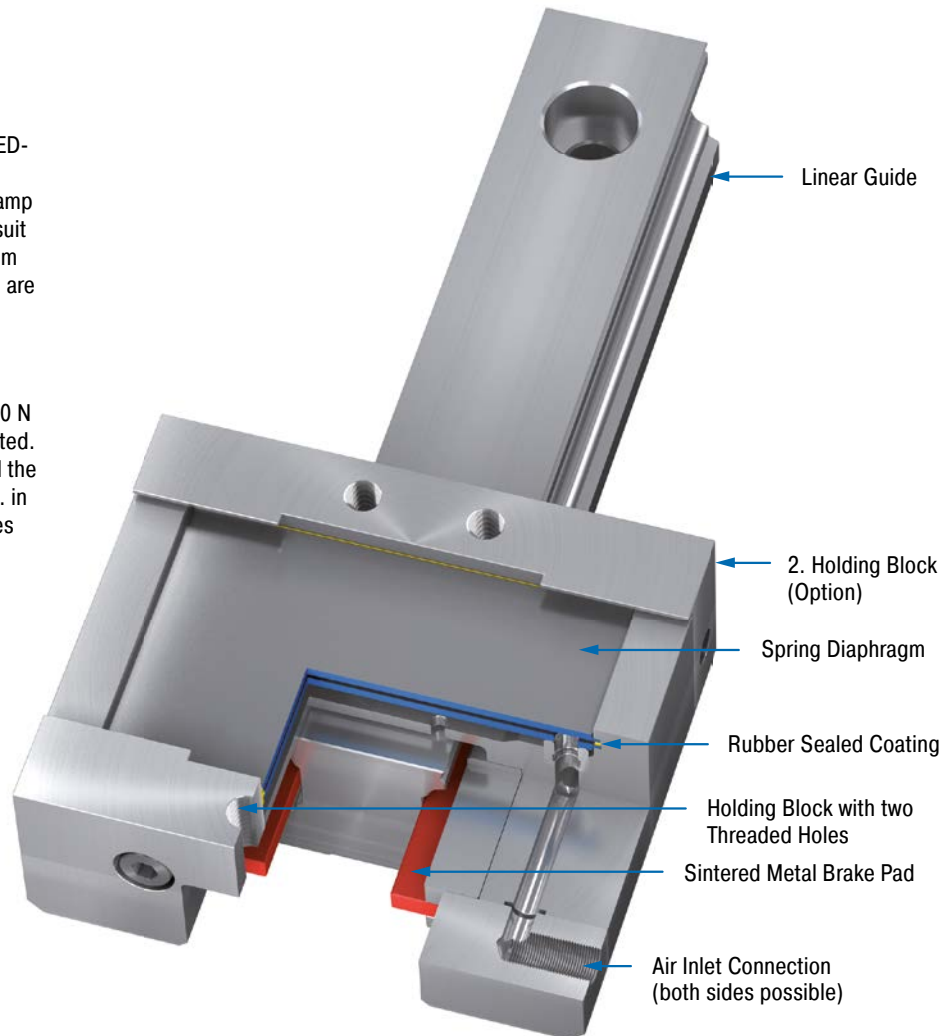

### Technical Data

**Holding forces:** 300 N to 2,100 N

**Rail sizes:** 15 mm to 55 mm

**Clamping cycles/emergency use:** 500

**Clamping cycles:** 1,000,000

**Mounting:** In any position

**Operating pressure:** 4 bar (automotive) or 6 bar

**Material:** Outer body: Tool steel; Brake components: Sintered graphite

**Pneumatic medium:** Dried, filtered air

**Operating temperature range:** 15 °C to 45 °C

**Application field:** Tool machines, Transport systems, Feeder installations, Positioning tables, Assembly stations

**Note:** If requested installation drawings of the respective types are provided.

**On request:** Special designs on request.

### SLK

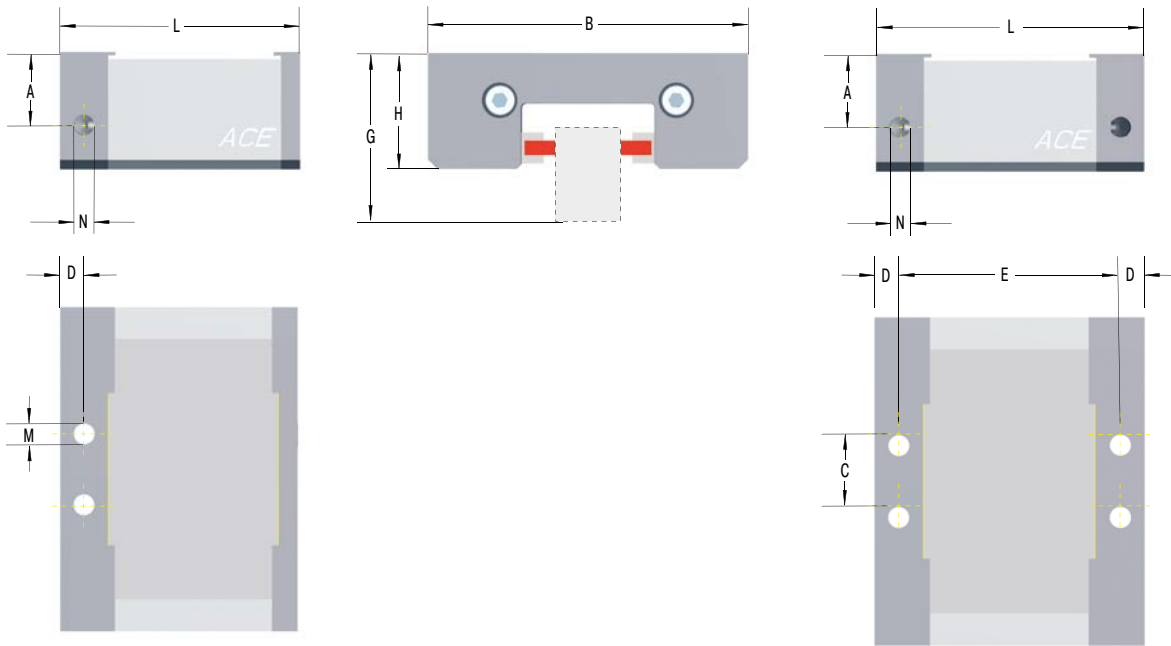

The calculation and selection of the most suitable clamping element should be carried out or be approved by ACE.

### Complete details required when ordering

- Operating pressure: 4 bar or 6 bar
- Number of holding blocks
- Rail manufacturer, rail type, rail size
- Carriage type name
- Number of clamping cycles per hour

### Ordering Example

Linear Safety Clamping Compact \_\_\_\_\_  
 Rail Nominal Size 45 mm \_\_\_\_\_  
 Number of Holding Blocks 1 \_\_\_\_\_  
 4B = 4 bar Type \_\_\_\_\_  
 6B = 6 bar Type \_\_\_\_\_  
 Series Number assigned by ACE \_\_\_\_\_

**SLK45-1-4B-X**

### Performance and Dimensions

| TYPES      | Holding force<br>N | Operating<br>pressure<br>bar | Low Carriage |         |         |         |         | High Carriage |         |         | M    | N  | Weight<br>kg |     |      |      |
|------------|--------------------|------------------------------|--------------|---------|---------|---------|---------|---------------|---------|---------|------|----|--------------|-----|------|------|
|            |                    |                              | B<br>mm      | C<br>mm | D<br>mm | E<br>mm | L<br>mm | A<br>mm       | G<br>mm | H<br>mm |      |    |              |     |      |      |
| SLK15-1-4B | 300                | 4                            | 45           | 12      | 5       | -       | 55.5    | 14.0          | 24      | 18      | 14.0 | -  | -            | M5  | M5   | 0.50 |
| SLK15-1-6B | 450                | 6                            | 45           | 12      | 5       | -       | 55.5    | 14.0          | 24      | 18      | 14.0 | -  | -            | M5  | M5   | 0.50 |
| SLK20-1-4B | 430                | 4                            | 54           | 16      | 5       | -       | 55.5    | 16.0          | 30      | 22      | 16.0 | -  | -            | M6  | M5   | 0.60 |
| SLK20-1-6B | 650                | 6                            | 54           | 16      | 5       | -       | 55.5    | 16.0          | 30      | 22      | 16.0 | -  | -            | M6  | M5   | 0.60 |
| SLK25-1-4B | 530                | 4                            | 75           | 16      | 5       | -       | 55.5    | 16.0          | 36      | 25.5    | 16.0 | 40 | 29.5         | M6  | M5   | 0.70 |
| SLK25-1-6B | 800                | 6                            | 75           | 16      | 5       | -       | 55.5    | 16.0          | 36      | 25.5    | 16.0 | 40 | 29.5         | M6  | M5   | 0.70 |
| SLK30-1-4B | 750                | 4                            | 89           | 18      | 8.75    | -       | 67      | 21.0          | 42      | 30      | 21.0 | 45 | 33           | M8  | M5   | 0.90 |
| SLK30-1-6B | 1,150              | 6                            | 89           | 18      | 8.75    | -       | 67      | 21.0          | 42      | 30      | 21.0 | 45 | 33           | M8  | M5   | 0.90 |
| SLK35-1-4B | 820                | 4                            | 96           | 22      | 8.75    | -       | 67      | 21.2          | 48      | 35      | 21.2 | 55 | 42           | M10 | G1/8 | 1.27 |
| SLK35-1-6B | 1,250              | 6                            | 96           | 22      | 8.75    | -       | 67      | 21.2          | 48      | 35      | 21.2 | 55 | 42           | M10 | G1/8 | 1.27 |
| SLK45-1-4B | 950                | 4                            | 116          | 28      | 10      | -       | 80      | 27.5          | 60      | 45      | 27.5 | 70 | 55           | M10 | G1/8 | 2.00 |
| SLK45-1-6B | 1,500              | 6                            | 116          | 28      | 10      | -       | 80      | 27.5          | 60      | 45      | 27.5 | 70 | 55           | M10 | G1/8 | 2.00 |
| SLK45-2-4B | 950                | 4                            | 116          | 28      | 10      | 72      | 92      | 27.5          | 60      | 45      | 27.5 | 70 | 55           | M10 | G1/8 | 2.20 |
| SLK45-2-6B | 1,500              | 6                            | 116          | 28      | 10      | 72      | 92      | 27.5          | 60      | 45      | 27.5 | 70 | 55           | M10 | G1/8 | 2.20 |
| SLK55-1-4B | 1,300              | 4                            | 136          | 34      | 10      | -       | 100     | 30.5          | 70      | 49      | 30.5 | 80 | 59           | M10 | G1/8 | 2.80 |
| SLK55-1-6B | 2,100              | 6                            | 136          | 34      | 10      | -       | 100     | 30.5          | 70      | 49      | 30.5 | 80 | 59           | M10 | G1/8 | 2.80 |
| SLK55-2-4B | 1,300              | 4                            | 136          | 34      | 10      | 92      | 112     | 30.5          | 70      | 49      | 30.5 | 80 | 59           | M10 | G1/8 | 3.00 |
| SLK55-2-6B | 2,100              | 6                            | 136          | 34      | 10      | 92      | 112     | 30.5          | 70      | 49      | 30.5 | 80 | 59           | M10 | G1/8 | 3.00 |

<sup>1</sup> The holding forces as shown in the capacity chart were determined on dry rails for roller systems (STAR, INA). Different holding forces may occur for other rails.

# LOCKED LZ-P

## Certified safety clamping

### Rail Clamping for Z-Axes

**Holding forces 1,500 N to 2,500 N**

Innovative and BG certified: The pneumatic clamping elements LOCKED LZ-P have been specially designed for safe, reliable clamping on the vertical or Z-axes. The wedge principle makes sure that the gravity loaded axis does not drop. The brake wedges are pushed on both sides against the flat parallel surfaces of the guide rail in case of a loss of pressure.

Initially developed for Bosch Rexroth rails in sizes 15 mm and 25 mm, a test certificate from the trade association was awarded after extensive tests on these clamping elements. Further certifications from other rail manufacturers and sizes are prepared and can be implemented within the shortest time. Users achieve holding forces of up to 2,500 N.

Pneumatic clamping elements LOCKED LZ-P are used in all sectors of modern mechanical engineering and customised machine tools.

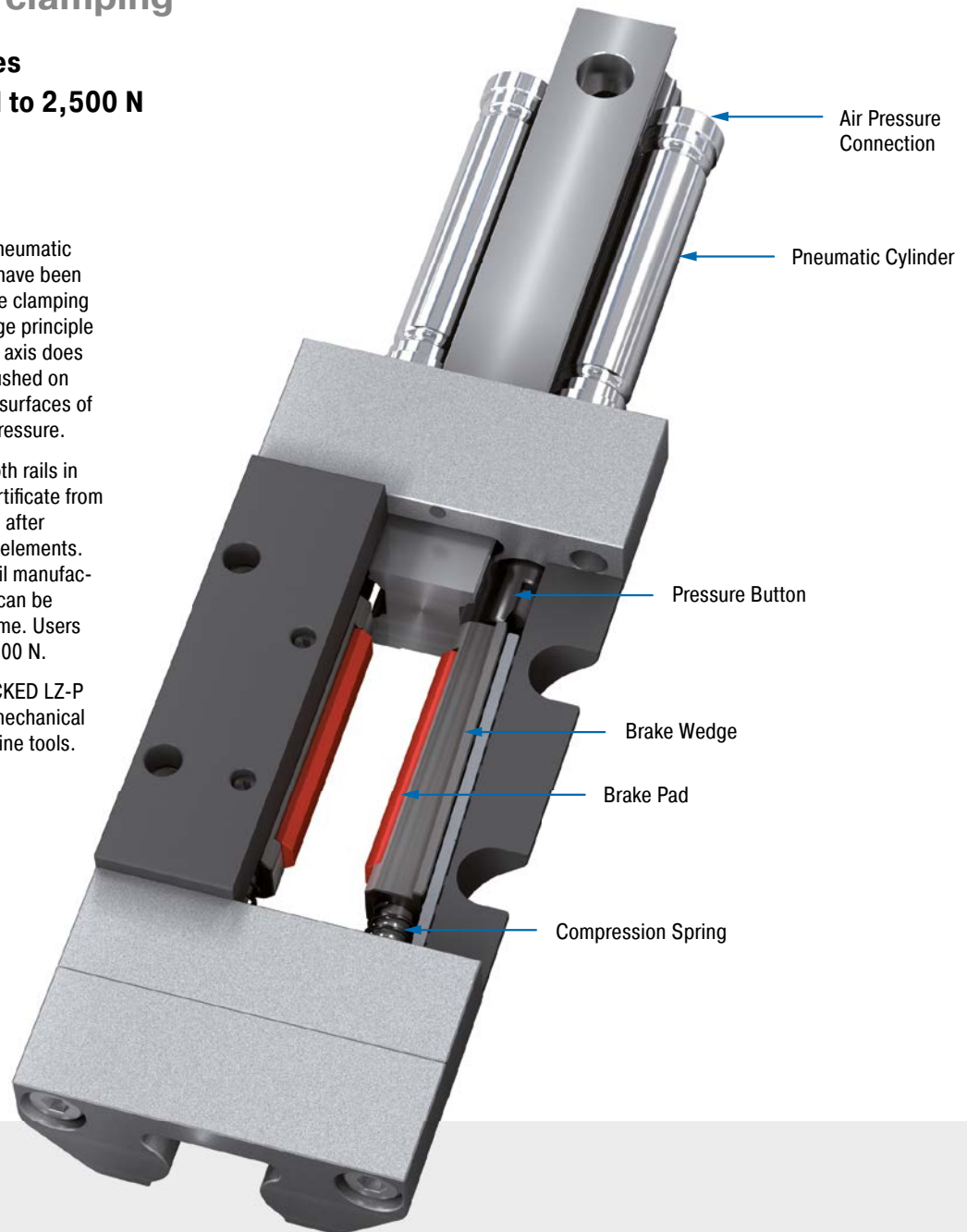

### Technical Data

**Holding forces:** 1,500 N to 2,500 N

**Rail sizes:** 15 mm and 25 mm Bosch Rexroth

**Clamping cycles:** 1,000,000

**Mounting:** Vertical

**Effective direction:** Z-axes toward gravity

**Operating pressure:** 4.8 bar to 8 bar

**Material:** Outer body: Tool steel; Brake components: Steel

**Pneumatic medium:** Dried, filtered air

**Operating temperature range:** 0 °C to 60 °C

**Application field:** Z-axes, Vertical conveyor systems, Jacking applications

### LZ-P

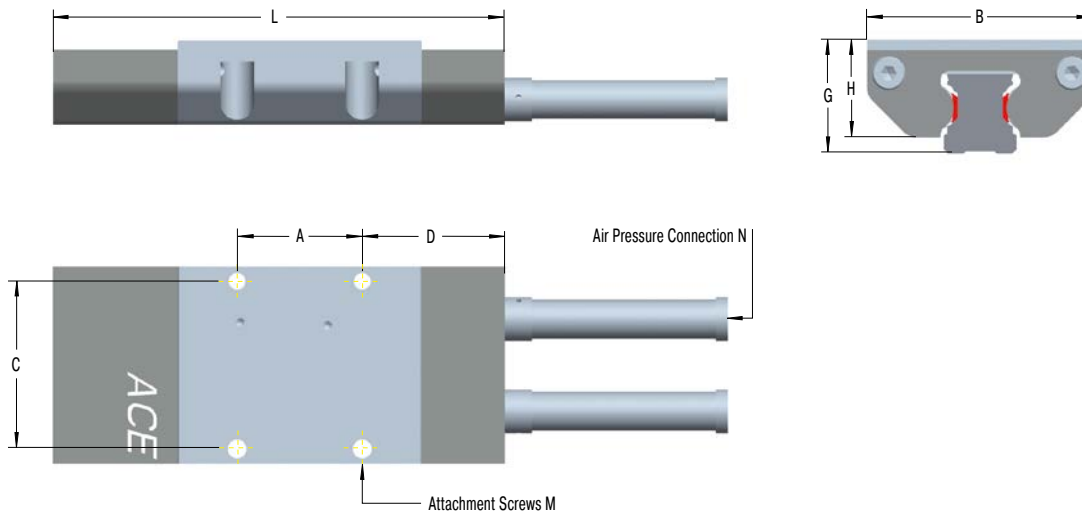

The calculation and selection of the most suitable clamping element should be carried out or be approved by ACE.

### Ordering Example

Process Clamping Z-Axis \_\_\_\_\_ **LZ-P15-X**  
 Rail Nominal Size 15 mm \_\_\_\_\_  
 Series Number assigned by ACE \_\_\_\_\_

### Performance and Dimensions

| TYPES    | Holding force<br>N | A<br>mm | B<br>mm | C<br>mm | D<br>mm | G<br>mm | H<br>mm | L<br>mm | M  | N  | Weight<br>kg |
|----------|--------------------|---------|---------|---------|---------|---------|---------|---------|----|----|--------------|
| LZ-P15-X | 1,500              | 30      | 47      | 40      | 34      | 24      | 20      | 108.5   | M4 | M3 | 0.40         |
| LZ-P25-X | 2,500              | 30      | 70      | 56      | 70      | 36      | 30      | 170.0   | M6 | M5 | 1.30         |



## LOCKED PN

### Rod clamping with maximum clamping force

#### Pneumatic Rod Clamping

**Holding forces 1,400 N to 36,000 N**

**Holding torques 15 Nm to 720 Nm**

Immediate clamping in case of loss of pneumatics: Suitable for rods with diameters of 20 mm to 40 mm, the clamping elements LOCKED PN absorb the forces axially and rotationally. With holding forces of up to 36,000 N, they reach or exceed the levels of hydraulic clamps. The system costs are however lower.

Alongside clamping in both directions of motion, the LOCKED-PN also surprises with its compact design. They need less installation space and enable short rod lengths. Many users appreciate the modular system. It allows several segments to be stacked so that the necessary clamping force can be attained for every application.

The areas of application for the ACE product family LOCKED PN are mechanical engineering and machine tools.

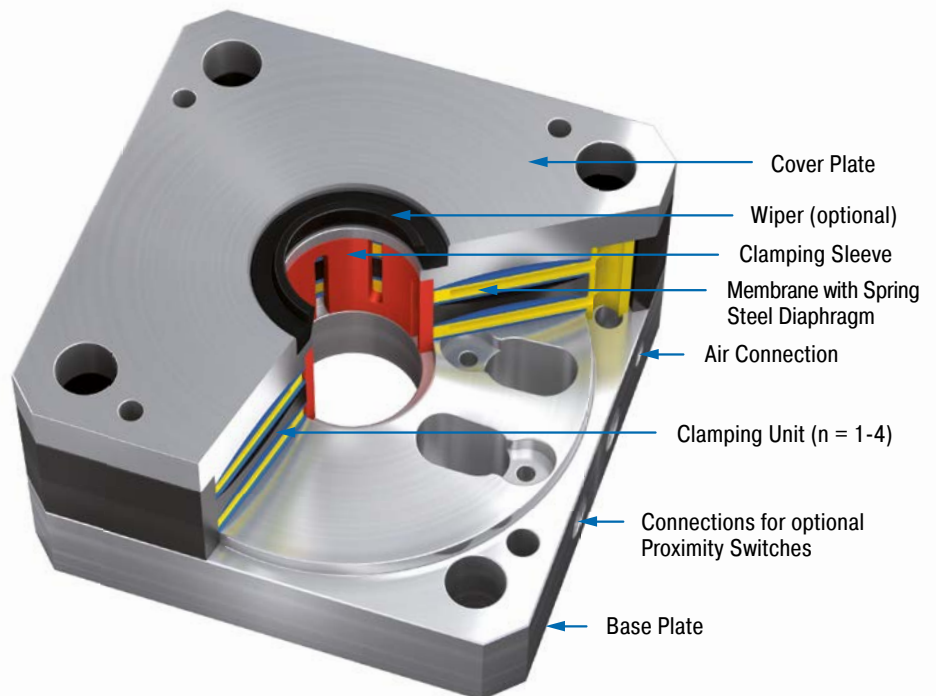

#### Technical Data

**Holding torques:** 15 Nm to 720 Nm

**Holding forces:** 1,400 N to 36,000 N

**Rod diameter:** Ø 20 mm to Ø 40 mm

**Clamping cycles:** 1,000,000

**Mounting:** In any position

**Operating pressure:** 4 bar (automotive) or 6 bar

**Material:** Outer body: Tool steel

**Pneumatic medium:** Dried, filtered air

**Operating temperature range:** 10 °C to 45 °C

**Application field:** Jacking systems, Light presses, Punching/stamping machines, Stacking units

**Note:** When mounting, use hardened piston rod.

**On request:** Special designs as for example special diameters and accessories available on request. Versions matching to ISO pneumatic cylinders including base plates coordinated to the dimensions of the flange sizes of standard cylinders according to ISO 15552 are also available.

### PN

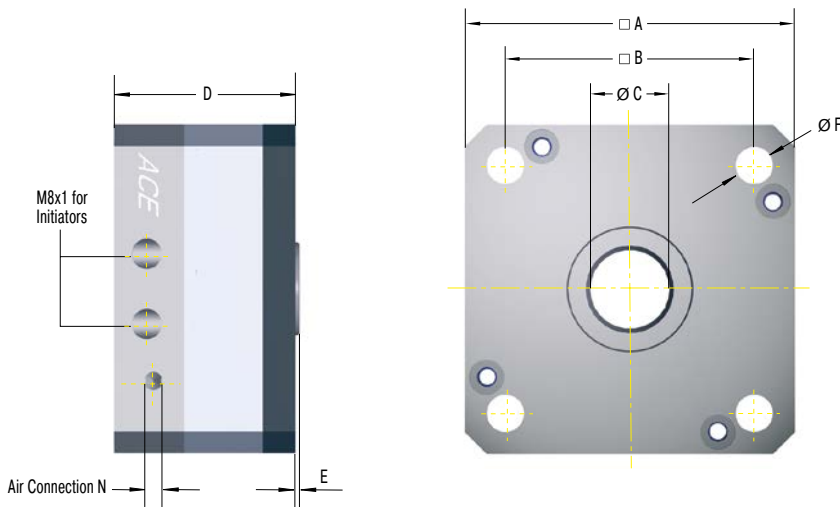

The calculation and selection of the most suitable clamping element should be carried out or be approved by ACE.

### Complete details required when ordering

Operating pressure: 4 bar or 6 bar

### Ordering Example

Rod Clamping Standard Model \_\_\_\_\_ **PN80-25-3-4B**  
 ISO Cylinder Nominal Diameter 80 mm \_\_\_\_\_  
 Rod Diameter 25 mm \_\_\_\_\_  
 Number of Clamping Units 3 \_\_\_\_\_  
 6B = 6 bar Type \_\_\_\_\_  
 4B = 4 bar Type \_\_\_\_\_

### Performance and Dimensions

| TYPES         | <sup>1</sup> Holding force<br>N | Holding torque<br>Nm | Operating pressure<br>bar | A<br>mm | B<br>mm | C<br>mm | D<br>mm | E<br>mm | F<br>mm | N    | Weight<br>kg |
|---------------|---------------------------------|----------------------|---------------------------|---------|---------|---------|---------|---------|---------|------|--------------|
| PN63-20-1-4B  | 1,400                           | 15                   | 4                         | 75      | 56.5    | 20      | 41.5    | 2.1     | 8.5     | M5   | 0.70         |
| PN63-20-1-6B  | 2,000                           | 20                   | 6                         | 75      | 56.5    | 20      | 41.5    | 2.1     | 8.5     | M5   | 0.70         |
| PN63-20-2-4B  | 2,520                           | 25                   | 4                         | 75      | 56.5    | 20      | 59.5    | 2.1     | 8.5     | M5   | 1.13         |
| PN63-20-2-6B  | 3,600                           | 35                   | 6                         | 75      | 56.5    | 20      | 59.5    | 2.1     | 8.5     | M5   | 1.13         |
| PN63-20-3-4B  | 3,780                           | 35                   | 4                         | 75      | 56.5    | 20      | 77.5    | 2.1     | 8.5     | M5   | 1.56         |
| PN63-20-3-6B  | 5,400                           | 50                   | 6                         | 75      | 56.5    | 20      | 77.5    | 2.1     | 8.5     | M5   | 1.56         |
| PN80-25-1-4B  | 2,100                           | 25                   | 4                         | 96      | 72      | 25      | 43.5    | 2.14    | 10.5    | G1/8 | 1.30         |
| PN80-25-1-6B  | 3,000                           | 35                   | 6                         | 96      | 72      | 25      | 43.5    | 2.14    | 10.5    | G1/8 | 1.30         |
| PN80-25-2-4B  | 3,780                           | 40                   | 4                         | 96      | 72      | 25      | 63.5    | 2.14    | 10.5    | G1/8 | 2.20         |
| PN80-25-2-6B  | 5,400                           | 60                   | 6                         | 96      | 72      | 25      | 63.5    | 2.14    | 10.5    | G1/8 | 2.20         |
| PN80-25-3-4B  | 5,670                           | 65                   | 4                         | 96      | 72      | 25      | 83.5    | 2.14    | 10.5    | G1/8 | 3.10         |
| PN80-25-3-6B  | 8,100                           | 95                   | 6                         | 96      | 72      | 25      | 83.5    | 2.14    | 10.5    | G1/8 | 3.10         |
| PN125-40-1-4B | 7,000                           | 140                  | 4                         | 145     | 110     | 40      | 51.6    | 3       | 13      | G1/8 | 3.65         |
| PN125-40-1-6B | 10,000                          | 200                  | 6                         | 145     | 110     | 40      | 51.6    | 3       | 13      | G1/8 | 3.65         |
| PN125-40-2-4B | 12,600                          | 250                  | 4                         | 145     | 110     | 40      | 75.2    | 3       | 13      | G1/8 | 5.85         |
| PN125-40-2-6B | 18,000                          | 360                  | 6                         | 145     | 110     | 40      | 75.2    | 3       | 13      | G1/8 | 5.85         |
| PN125-40-3-4B | 18,900                          | 375                  | 4                         | 145     | 110     | 40      | 98.8    | 3       | 13      | G1/8 | 8.05         |
| PN125-40-3-6B | 27,000                          | 540                  | 6                         | 145     | 110     | 40      | 98.8    | 3       | 13      | G1/8 | 8.05         |
| PN125-40-4-4B | 25,200                          | 500                  | 4                         | 145     | 110     | 40      | 122.4   | 3       | 13      | G1/8 | 10.25        |
| PN125-40-4-6B | 36,000                          | 720                  | 6                         | 145     | 110     | 40      | 122.4   | 3       | 13      | G1/8 | 10.25        |

<sup>1</sup> The listed holding forces are reached under optimum conditions. We recommend a safety factor of > 10 %. Please note that surface, material and cleanliness of the rod as well as wear and tear and the use of rod wipers lead to different holding forces. Test the clamping needed for series production or safety applications in its specific application environment and measure the actual values.

## LOCKED PRK

### Rod clamping with maximum clamping force in a compact size

#### Pneumatic Rod Clamping, Compact Holding forces 700 N to 5,000 N Holding torques 7 Nm to 100 Nm

Compact and safe: when space becomes restricted, the compact LOCKED PRK clamping elements come into their own. As pneumatic rod clamping with low heights of 28 mm to 34 mm, they provide clamping forces of up to 5,000 N.

Clamping is carried out by a diaphragm spring-plate system and is released when compressed air is applied. Clamping elements from the LOCKED PRK product family absorb the forces on rods with diameters between 20 mm and 40 mm both axially and rotationally. The function makes them suitable for use as static clamping without pressure, because the failure or drop of pneumatic pressure triggers immediate clamping. High clamping forces with low system costs compared with hydraulic and electric solutions make these clamping elements particularly interesting.

LOCKED PRK models are used in mechanical engineering and customised machine tools.

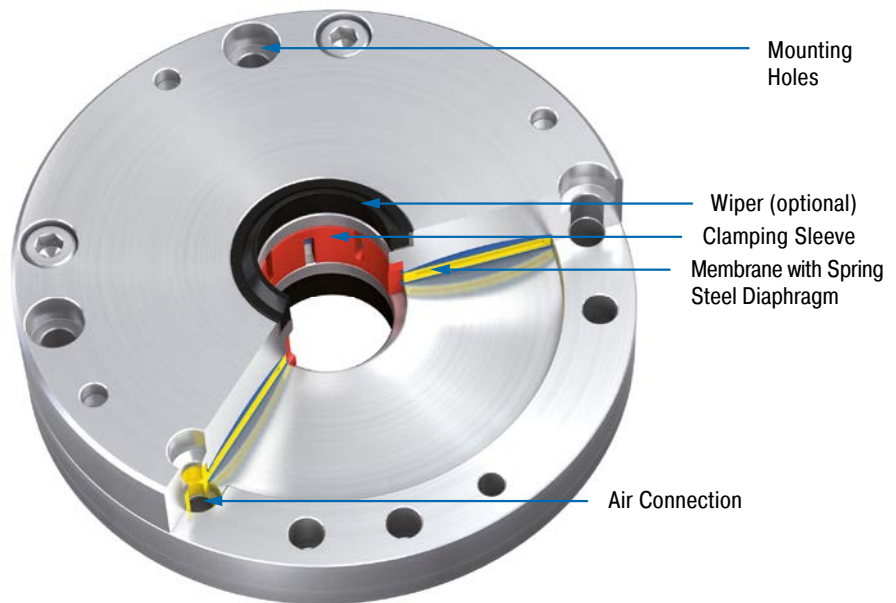

### Technical Data

**Holding torques:** 7 Nm to 100 Nm

**Holding forces:** 700 N to 5,000 N

**Rod diameter:** Ø 20 mm to Ø 40 mm

**Clamping cycles:** 1,000,000

**Mounting:** In any position

**Operating pressure:** 4 bar (automotive) or 6 bar

**Material:** Outer body: Tool steel

**Pneumatic medium:** Dried, filtered air

**Operating temperature range:** 10 °C to 45 °C

**Application field:** Jacking systems, Light presses, Punching/stamping machines, Stacking units

**Note:** When mounting, use hardened piston rod.

**On request:** Special designs as for example special diameters and accessories available on request. Versions matching to ISO pneumatic cylinders including base plates coordinated to the dimensions of the flange sizes of standard cylinders according to ISO 15552 are also available.

### PRK

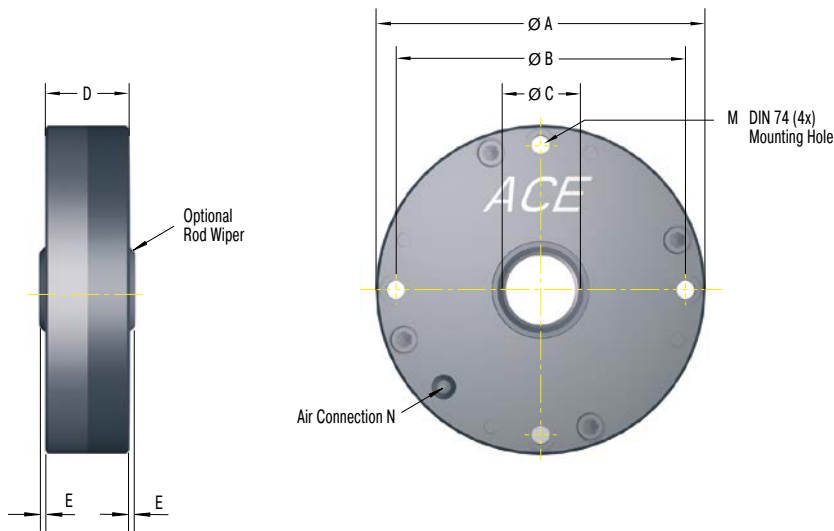

The calculation and selection of the most suitable clamping element should be carried out or be approved by ACE.

### Complete details required when ordering

Operating pressure: 4 bar or 6 bar

### Ordering Example

Rod Clamping Compact PRK80-25-6B  
 ISO Cylinder Nominal Diameter 80 mm  
 Rod Diameter 25 mm  
 6B = 6 bar Type  
 4B = 4 bar Type

### Performance and Dimensions

| TYPES        | <sup>1</sup> Holding force<br>N | Holding torque<br>Nm | Operating pressure<br>bar | A<br>mm | B<br>mm | C<br>mm | D<br>mm | E<br>mm | M  | N    | Weight<br>kg |
|--------------|---------------------------------|----------------------|---------------------------|---------|---------|---------|---------|---------|----|------|--------------|
| PRK63-20-4B  | 700                             | 7                    | 4                         | 92      | 80      | 20      | 28      | 2.1     | M5 | G1/8 | 1.15         |
| PRK63-20-6B  | 1,000                           | 10                   | 6                         | 92      | 80      | 20      | 28      | 2.1     | M5 | G1/8 | 1.15         |
| PRK80-25-4B  | 1,050                           | 12                   | 4                         | 118     | 104     | 25      | 28.6    | 2.14    | M6 | G1/8 | 2.10         |
| PRK80-25-6B  | 1,500                           | 17                   | 6                         | 118     | 104     | 25      | 28.6    | 2.14    | M6 | G1/8 | 2.10         |
| PRK125-40-4B | 3,500                           | 70                   | 4                         | 168     | 152     | 40      | 28.6    | 3       | M6 | G1/8 | 4.90         |
| PRK125-40-6B | 5,000                           | 100                  | 6                         | 168     | 152     | 40      | 28.6    | 3       | M6 | G1/8 | 4.90         |

<sup>1</sup> The listed holding forces are reached under optimum conditions. We recommend a safety factor of > 10 %. Please note that surface, material and cleanliness of the rod as well as wear and tear and the use of rod wipers lead to different holding forces. Test the clamping needed for series production or safety applications in its specific application environment and measure the actual values.

## LOCKED R

### Strong holding force on the shaft

#### Pneumatic Rotational Clamping Holding torques 42 Nm to 4,680 Nm

Direct clamping on the shaft: Rotation motions are prevented by the ACE models LOCKED R. Their clamping elements are available for shaft diameters of 50 mm to 340 mm and ensure maximum holding forces.

The clamp is immediately applied by the diaphragm and spring-plate system when pressure is lost. Pneumatic quick-switch valves reduce the reaction times. The costs are low in comparison with hydraulic clamping systems. Their performance is, however, achieved or exceeded despite the compact and easy to assemble design. Special versions for YRT bearings as well as active clamping elements are additionally available. ACE recommends the use of the optional shaft flange as wear protection. The clamping force can be increased considerably by the use of the additional air function.

Models from the LOCKED R product family are used in mechanical engineering and customised machine tools.

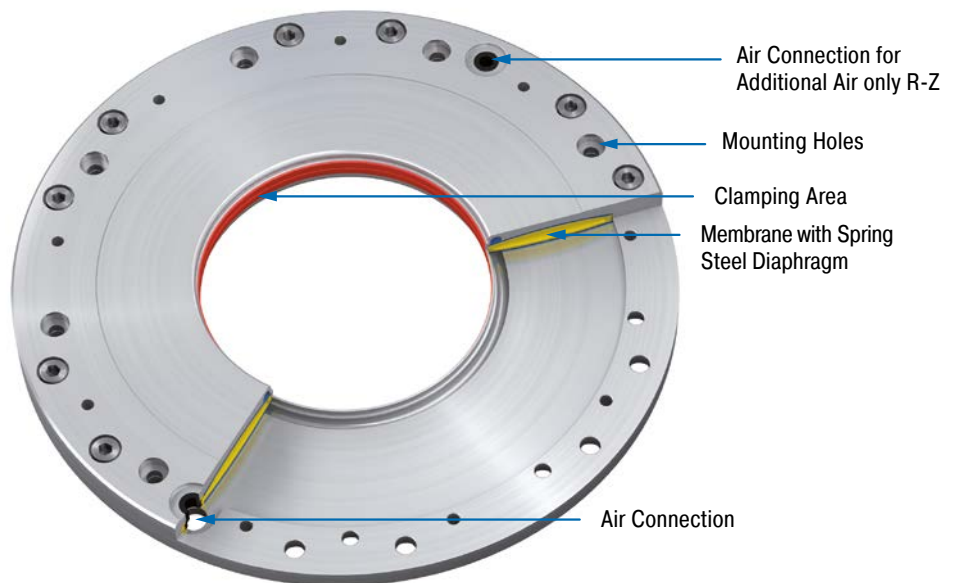

#### Technical Data

**Holding torques:** 42 Nm to 4,680 Nm

**Shaft diameter:** Ø 50 mm to Ø 340 mm

**Clamping cycles:** 1,000,000

**Mounting:** In any position

**Operating pressure:** 4 bar (automotive) or 6 bar

**Material:** Outer body: Hardened fine-grain structural steel, inner bore ground

**Pneumatic medium:** Dried, filtered air

**Operating temperature range:** 10 °C to 45 °C

**Application field:** Drive shafts, Torque motors, Conveyor systems

**Note:** If requested installation drawings of the respective types are provided.

**On request:** Special designs and customised solutions e.g. YRT bearing up to Ø 460 mm and shaft flange available on request.

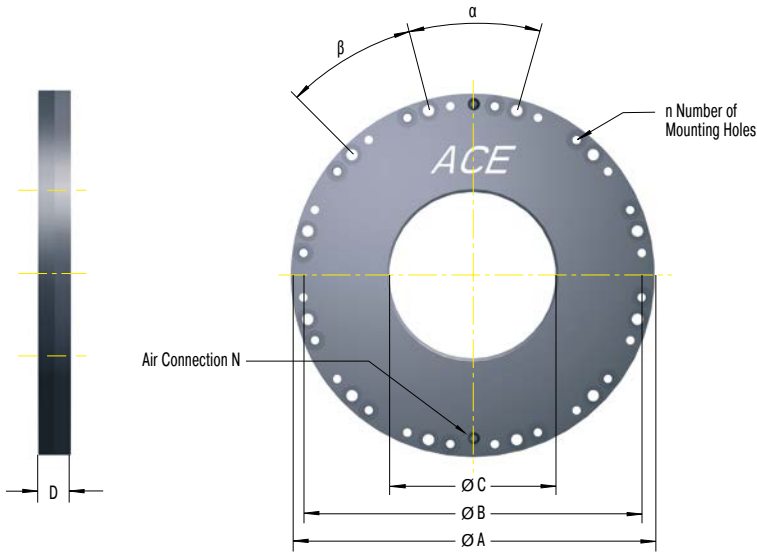
**R**

The calculation and selection of the most suitable clamping element should be carried out or be approved by ACE.

### Complete details required when ordering

Operating pressure: 4 bar or 6 bar

### Ordering Example

Rotational Clamping **R80-6B**  
 Shaft Nominal Diameter 80 mm  
 6B = 6 bar Type  
 4B = 4 bar Type

### Performance and Dimensions

| TYPES   | Holding torque<br>Nm | Operating pressure<br>bar | A<br>mm | B<br>mm | C opened<br>mm | Shaft Diameter<br>mm | D<br>mm | N    | n  | $\alpha$<br>° | $\beta$<br>° | Weight<br>kg |
|---------|----------------------|---------------------------|---------|---------|----------------|----------------------|---------|------|----|---------------|--------------|--------------|
| R50-4B  | 42                   | 4                         | 145     | 134     | 50+0.03/+0.05  | 50-0.01/-0.025       | 15      | M5   | 8  | 45            | 45           | 1.7          |
| R50-6B  | 60                   | 6                         | 145     | 134     | 50+0.03/+0.05  | 50-0.01/-0.025       | 15      | M5   | 8  | 45            | 45           | 1.7          |
| R60-4B  | 59                   | 4                         | 155     | 144     | 60+0.03/+0.05  | 60-0.01/-0.025       | 15      | M5   | 8  | 45            | 45           | 1.9          |
| R60-6B  | 84                   | 6                         | 155     | 144     | 60+0.03/+0.05  | 60-0.01/-0.025       | 15      | M5   | 8  | 45            | 45           | 1.9          |
| R70-4B  | 80                   | 4                         | 165     | 154     | 70+0.03/+0.05  | 70-0.01/-0.025       | 15      | M5   | 12 | 30            | 30           | 2.1          |
| R70-6B  | 114                  | 6                         | 165     | 154     | 70+0.03/+0.05  | 70-0.01/-0.025       | 15      | M5   | 12 | 30            | 30           | 2.1          |
| R80-4B  | 105                  | 4                         | 175     | 164     | 80+0.03/+0.05  | 80-0.01/-0.025       | 15      | M5   | 12 | 30            | 30           | 2.3          |
| R80-6B  | 150                  | 6                         | 175     | 164     | 80+0.03/+0.05  | 80-0.01/-0.025       | 15      | M5   | 12 | 30            | 30           | 2.3          |
| R90-4B  | 132                  | 4                         | 185     | 174     | 90+0.03/+0.05  | 90-0.01/-0.025       | 15      | M5   | 12 | 30            | 30           | 2.5          |
| R90-6B  | 189                  | 6                         | 185     | 174     | 90+0.03/+0.05  | 90-0.01/-0.025       | 15      | M5   | 12 | 30            | 30           | 2.5          |
| R100-4B | 168                  | 4                         | 228     | 210     | 100+0.04/+0.06 | 100-0.01/-0.025      | 16      | G1/8 | 12 | 40            | 20           | 4.1          |
| R100-6B | 240                  | 6                         | 228     | 210     | 100+0.04/+0.06 | 100-0.01/-0.025      | 16      | G1/8 | 12 | 40            | 20           | 4.1          |
| R120-4B | 235                  | 4                         | 248     | 230     | 120+0.04/+0.06 | 120-0.01/-0.025      | 16      | G1/8 | 12 | 40            | 20           | 4.6          |
| R120-6B | 336                  | 6                         | 248     | 230     | 120+0.04/+0.06 | 120-0.01/-0.025      | 16      | G1/8 | 12 | 40            | 20           | 4.6          |
| R140-4B | 319                  | 4                         | 268     | 250     | 140+0.04/+0.06 | 140-0.01/-0.025      | 16      | G1/8 | 12 | 40            | 20           | 5.1          |
| R140-6B | 456                  | 6                         | 268     | 250     | 140+0.04/+0.06 | 140-0.01/-0.025      | 16      | G1/8 | 12 | 40            | 20           | 5.1          |
| R160-4B | 420                  | 4                         | 288     | 270     | 160+0.04/+0.06 | 160-0.01/-0.025      | 16      | G1/8 | 12 | 40            | 20           | 5.6          |
| R160-6B | 600                  | 6                         | 288     | 270     | 160+0.04/+0.06 | 160-0.01/-0.025      | 16      | G1/8 | 12 | 40            | 20           | 5.6          |
| R180-4B | 525                  | 4                         | 308     | 290     | 180+0.04/+0.06 | 180-0.01/-0.025      | 20      | G1/8 | 16 | 30            | 15           | 7.7          |
| R180-6B | 750                  | 6                         | 308     | 290     | 180+0.04/+0.06 | 180-0.01/-0.025      | 20      | G1/8 | 16 | 30            | 15           | 7.7          |
| R200-4B | 651                  | 4                         | 328     | 310     | 200+0.05/+0.07 | 200-0.01/-0.03       | 20      | G1/8 | 16 | 30            | 15           | 8.3          |
| R200-6B | 930                  | 6                         | 328     | 310     | 200+0.05/+0.07 | 200-0.01/-0.03       | 20      | G1/8 | 16 | 30            | 15           | 8.3          |
| R220-4B | 777                  | 4                         | 348     | 330     | 220+0.05/+0.07 | 220-0.01/-0.03       | 20      | G1/8 | 16 | 30            | 15           | 8.9          |
| R220-6B | 1,110                | 6                         | 348     | 330     | 220+0.05/+0.07 | 220-0.01/-0.03       | 20      | G1/8 | 16 | 30            | 15           | 8.9          |
| R240-4B | 945                  | 4                         | 368     | 350     | 240+0.05/+0.07 | 240-0.01/-0.03       | 20      | G1/8 | 24 | 20            | 10           | 9.5          |
| R240-6B | 1,350                | 6                         | 368     | 350     | 240+0.05/+0.07 | 240-0.01/-0.03       | 20      | G1/8 | 24 | 20            | 10           | 9.5          |
| R260-4B | 1,092                | 4                         | 388     | 370     | 260+0.05/+0.07 | 260-0.01/-0.03       | 22      | G1/8 | 24 | 20            | 10           | 11.2         |
| R260-6B | 1,560                | 6                         | 388     | 370     | 260+0.05/+0.07 | 260-0.01/-0.03       | 22      | G1/8 | 24 | 20            | 10           | 11.2         |
| R280-4B | 1,260                | 4                         | 408     | 390     | 280+0.05/+0.07 | 280-0.01/-0.03       | 22      | G1/8 | 24 | 20            | 10           | 11.9         |
| R280-6B | 1,800                | 6                         | 408     | 390     | 280+0.05/+0.07 | 280-0.01/-0.03       | 22      | G1/8 | 24 | 20            | 10           | 11.9         |
| R300-4B | 1,470                | 4                         | 428     | 410     | 300+0.05/+0.07 | 300-0.01/-0.03       | 22      | G1/8 | 24 | 20            | 10           | 12.6         |
| R300-6B | 2,100                | 6                         | 428     | 410     | 300+0.05/+0.07 | 300-0.01/-0.03       | 22      | G1/8 | 24 | 20            | 10           | 12.6         |
| R320-4B | 1,638                | 4                         | 448     | 430     | 320+0.05/+0.07 | 320-0.01/-0.03       | 22      | G1/8 | 24 | 20            | 10           | 13.1         |
| R320-6B | 2,340                | 6                         | 448     | 430     | 320+0.05/+0.07 | 320-0.01/-0.03       | 22      | G1/8 | 24 | 20            | 10           | 13.1         |
| R340-4B | 1,806                | 4                         | 468     | 450     | 340+0.05/+0.07 | 340-0.01/-0.03       | 22      | G1/8 | 24 | 20            | 10           | 14.0         |
| R340-6B | 2,580                | 6                         | 468     | 450     | 340+0.05/+0.07 | 340-0.01/-0.03       | 22      | G1/8 | 24 | 20            | 10           | 14.0         |



R-Z

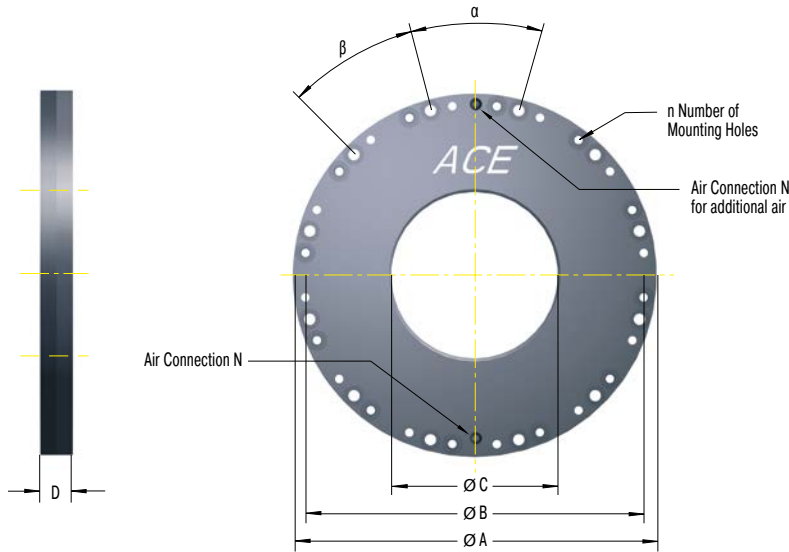

The calculation and selection of the most suitable clamping element should be carried out or be approved by ACE.

Complete details required when ordering

Operating pressure: 4 bar or 6 bar

Ordering Example

Rotational Clamping R80-Z-6B  
 Shaft Nominal Diameter 80 mm  
 Z = Increased Force with Additional Air  
 6B = 6 bar Type  
 4B = 4 bar Type

Performance and Dimensions

| TYPES     | Holding torque<br>Nm | Operating pressure<br>bar | A<br>mm | B<br>mm | C opened<br>mm | Shaft Diameter<br>mm | D<br>mm | N    | n  | $\alpha$<br>° | $\beta$<br>° | Weight<br>kg |
|-----------|----------------------|---------------------------|---------|---------|----------------|----------------------|---------|------|----|---------------|--------------|--------------|
| R50-Z-4B  | 76                   | 4                         | 145     | 134     | 50+0.03/+0.05  | 50-0.01/-0.025       | 15      | M5   | 8  | 45            | 45           | 1.7          |
| R50-Z-6B  | 108                  | 6                         | 145     | 134     | 50+0.03/+0.05  | 50-0.01/-0.025       | 15      | M5   | 8  | 45            | 45           | 1.7          |
| R60-Z-4B  | 107                  | 4                         | 155     | 144     | 60+0.03/+0.05  | 60-0.01/-0.025       | 15      | M5   | 8  | 45            | 45           | 1.9          |
| R60-Z-6B  | 153                  | 6                         | 155     | 144     | 60+0.03/+0.05  | 60-0.01/-0.025       | 15      | M5   | 8  | 45            | 45           | 1.9          |
| R70-Z-4B  | 147                  | 4                         | 165     | 154     | 70+0.03/+0.05  | 70-0.01/-0.025       | 15      | M5   | 12 | 30            | 30           | 2.1          |
| R70-Z-6B  | 210                  | 6                         | 165     | 154     | 70+0.03/+0.05  | 70-0.01/-0.025       | 15      | M5   | 12 | 30            | 30           | 2.1          |
| R80-Z-4B  | 189                  | 4                         | 175     | 164     | 80+0.03/+0.05  | 80-0.01/-0.025       | 15      | M5   | 12 | 30            | 30           | 2.3          |
| R80-Z-6B  | 270                  | 6                         | 175     | 164     | 80+0.03/+0.05  | 80-0.01/-0.025       | 15      | M5   | 12 | 30            | 30           | 2.3          |
| R90-Z-4B  | 239                  | 4                         | 185     | 174     | 90+0.03/+0.05  | 90-0.01/-0.025       | 15      | M5   | 12 | 30            | 30           | 2.5          |
| R90-Z-6B  | 342                  | 6                         | 185     | 174     | 90+0.03/+0.05  | 90-0.01/-0.025       | 15      | M5   | 12 | 30            | 30           | 2.5          |
| R100-Z-4B | 294                  | 4                         | 228     | 210     | 100+0.04/+0.06 | 100-0.01/-0.025      | 16      | G1/8 | 12 | 40            | 20           | 4.1          |
| R100-Z-6B | 420                  | 6                         | 228     | 210     | 100+0.04/+0.06 | 100-0.01/-0.025      | 16      | G1/8 | 12 | 40            | 20           | 4.1          |
| R120-Z-4B | 420                  | 4                         | 248     | 230     | 120+0.04/+0.06 | 120-0.01/-0.025      | 16      | G1/8 | 12 | 40            | 20           | 4.6          |
| R120-Z-6B | 600                  | 6                         | 248     | 230     | 120+0.04/+0.06 | 120-0.01/-0.025      | 16      | G1/8 | 12 | 40            | 20           | 4.6          |
| R140-Z-4B | 588                  | 4                         | 268     | 250     | 140+0.04/+0.06 | 140-0.01/-0.025      | 16      | G1/8 | 12 | 40            | 20           | 5.1          |
| R140-Z-6B | 840                  | 6                         | 268     | 250     | 140+0.04/+0.06 | 140-0.01/-0.025      | 16      | G1/8 | 12 | 40            | 20           | 5.1          |
| R160-Z-4B | 756                  | 4                         | 288     | 270     | 160+0.04/+0.06 | 160-0.01/-0.025      | 16      | G1/8 | 12 | 40            | 20           | 5.6          |
| R160-Z-6B | 1,080                | 6                         | 288     | 270     | 160+0.04/+0.06 | 160-0.01/-0.025      | 16      | G1/8 | 12 | 40            | 20           | 5.6          |
| R180-Z-4B | 966                  | 4                         | 308     | 290     | 180+0.04/+0.06 | 180-0.01/-0.025      | 20      | G1/8 | 16 | 30            | 15           | 7.7          |
| R180-Z-6B | 1,380                | 6                         | 308     | 290     | 180+0.04/+0.06 | 180-0.01/-0.025      | 20      | G1/8 | 16 | 30            | 15           | 7.7          |
| R200-Z-4B | 1,176                | 4                         | 328     | 310     | 200+0.05/+0.07 | 200-0.01/-0.03       | 20      | G1/8 | 16 | 30            | 15           | 8.3          |
| R200-Z-6B | 1,680                | 6                         | 328     | 310     | 200+0.05/+0.07 | 200-0.01/-0.03       | 20      | G1/8 | 16 | 30            | 15           | 8.3          |
| R220-Z-4B | 1,428                | 4                         | 348     | 330     | 220+0.05/+0.07 | 220-0.01/-0.03       | 20      | G1/8 | 16 | 30            | 15           | 8.9          |
| R220-Z-6B | 2,040                | 6                         | 348     | 330     | 220+0.05/+0.07 | 220-0.01/-0.03       | 20      | G1/8 | 16 | 30            | 15           | 8.9          |
| R240-Z-4B | 1,680                | 4                         | 368     | 350     | 240+0.05/+0.07 | 240-0.01/-0.03       | 20      | G1/8 | 24 | 20            | 10           | 8.9          |
| R240-Z-6B | 2,400                | 6                         | 368     | 350     | 240+0.05/+0.07 | 240-0.01/-0.03       | 20      | G1/8 | 24 | 20            | 10           | 8.9          |
| R260-Z-4B | 1,974                | 4                         | 388     | 370     | 260+0.05/+0.07 | 260-0.01/-0.03       | 22      | G1/8 | 24 | 20            | 10           | 11.2         |
| R260-Z-6B | 2,820                | 6                         | 388     | 370     | 260+0.05/+0.07 | 260-0.01/-0.03       | 22      | G1/8 | 24 | 20            | 10           | 11.2         |
| R280-Z-4B | 2,268                | 4                         | 408     | 390     | 280+0.05/+0.07 | 280-0.01/-0.03       | 22      | G1/8 | 24 | 20            | 10           | 11.9         |
| R280-Z-6B | 3,240                | 6                         | 408     | 390     | 280+0.05/+0.07 | 280-0.01/-0.03       | 22      | G1/8 | 24 | 20            | 10           | 11.9         |
| R300-Z-4B | 2,604                | 4                         | 428     | 410     | 300+0.05/+0.07 | 300-0.01/-0.03       | 22      | G1/8 | 24 | 20            | 10           | 12.6         |
| R300-Z-6B | 3,720                | 6                         | 428     | 410     | 300+0.05/+0.07 | 300-0.01/-0.03       | 22      | G1/8 | 24 | 20            | 10           | 12.6         |
| R320-Z-4B | 2,940                | 4                         | 448     | 430     | 320+0.05/+0.07 | 320-0.01/-0.03       | 22      | G1/8 | 24 | 20            | 10           | 13.1         |
| R320-Z-6B | 4,200                | 6                         | 448     | 430     | 320+0.05/+0.07 | 320-0.01/-0.03       | 22      | G1/8 | 24 | 20            | 10           | 13.1         |
| R340-Z-4B | 3,276                | 4                         | 468     | 450     | 340+0.05/+0.07 | 340-0.01/-0.03       | 22      | G1/8 | 24 | 20            | 10           | 14.0         |
| R340-Z-6B | 4,680                | 6                         | 468     | 450     | 340+0.05/+0.07 | 340-0.01/-0.03       | 22      | G1/8 | 24 | 20            | 10           | 14.0         |

Issue 07.2017 – Specifications subject to change

# Application Examples

## SL Special LOCKED SL elements for emergency stops

In order to secure the processing position of a special lathe in both the horizontal and the vertical axis, ACE LOCKED elements of the type SL35-1-6B are installed. They have the further advantage of preventing slippage through the vertical axis in the case of a malfunction. The products used in the SL-series not only have the correct track width and offer very high process clamping forces of up to 10,000 N, but can also apply the same force as an emergency-stop braking function. This is due to the specially integrated brake linings made of low-wear sintered metal.



ACE clamping and safety elements maintain a rock-solid hold on the axes in special lathes and secure the predetermined positions both horizontally and vertically  
RASOMA Werkzeugmaschinen GmbH, 04720 Döbeln, Germany

## SLK Secure rail clamping

ACE clamping elements secure machines in the tyre industry. The goods accumulator/compensator of a material dispenser carries meandering, coiled, highly tear resistant material strips, which are fed at high speed to a tyre-manufacturing machine. To prevent damaging the machine, innovative type SLK25-1-6B clamping elements are employed.



Secure material accumulator

**PN**  
**Clamping elements as a variable stop**

ACE clamping elements are inserted, as a variable stop, during a joining process for the production of drilling tools. They meet the requirements for a precise positioning of the workpiece head and an adaptation of the length tolerance of up to 3 mm, ideally. ACE was awarded the contract because the clamping element is attached on a bar and its PN LOCKED series is specifically designed for this purpose. For clamping on linear guides, rails, axles and shafts, ACE offers a great range of high-performance models.

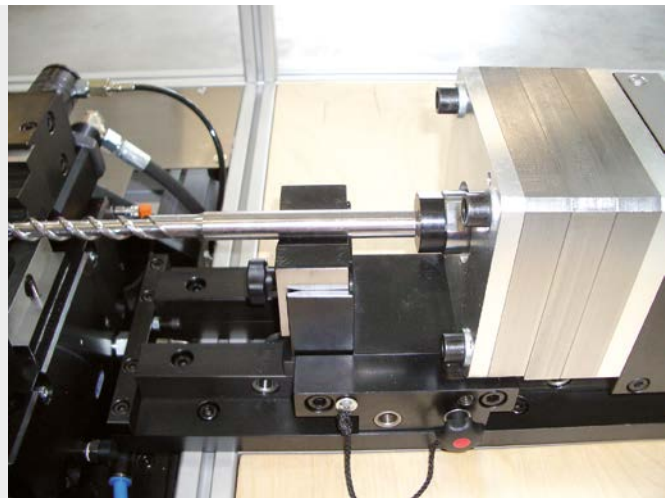

ACE clamping elements assist in the production of drilling tools: the LOCKED-P system clamps and at the same time absorbs the opposing forces of the joining process without difficulty  
GRAF automation GmbH, 88214 Ravensburg, Germany

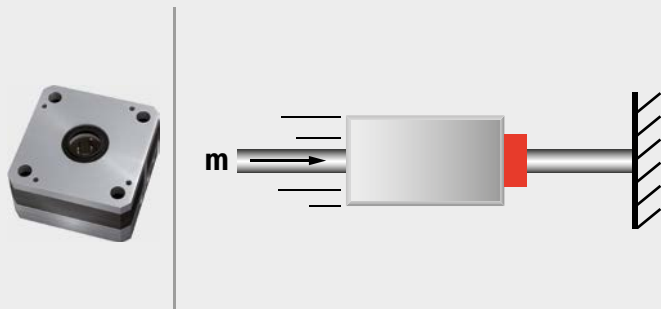

**PN**  
**Secure rod clamping**

Pneumatic rod clamping allows hydraulic presses to be used for any application. With the help of hydraulic presses, cut ceramic parts are manufactured during the week. So that the rods of the upper and lower stamping plate do not sag when the press is at a standstill over the weekend or during holidays and therefore have to be setup again on the next working day, PN80-25-2-6B type rod clamps are used.

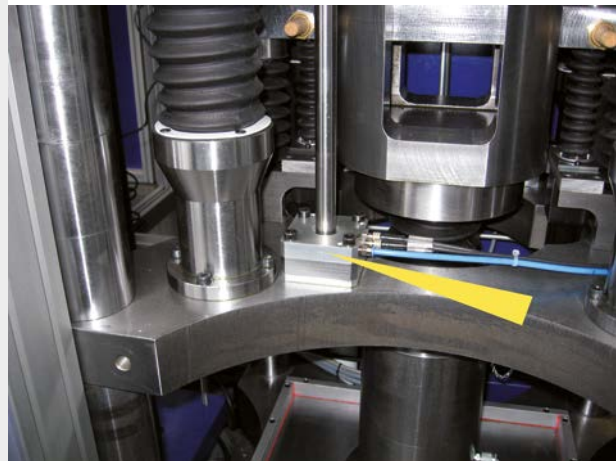

Pneumatic rod clamping allows hydraulic presses to be used for any application  
KOMAGE Gellner Maschinenfabrik KG, 54427 Kell am See, Germany





# ACE Expertise Compact

## Lectures, training courses and a new demonstration vehicle

### Free and Convenient in your Premises

**Whether in the training vehicle or through lectures: we have a lot to tell. Images, tests and concrete products at your location convey information much more quickly and plausibly than speech or written materials.**

In our free specialised lectures we clearly demonstrate the function and mode of operation of the damping elements. Fast, compact and completely tailored to suit you. ACE presentations include video material, a lot of application images, drop tester and a pneumatic demonstration unit along with original "live" products.

We illuminate kinetic energies and the impact on production processes, design and mode of operation of shock absorbers, we compare techniques, calculate, perform tests and show typical applications.

### Even more Compact: Training in the ACE Demonstration Vehicle

In 60 minutes, everything about automation control, motion control, vibration control and ACE safety products. Right at your premises on the parking lot.

Learn how you can increase your production, go easy on your machines, reduce noise and vibrations, simplify designs and save costs.

**Ideal for smaller groups of about 8 people.**





# Fax Request

## Our free and fast service

Do you need the new main catalogue? Are you interested in ACE lectures and presentations?  
Or a training course in the ACE demonstration vehicle with field representatives of your choice?

We offer compact, tailored presentation packages. These illustrate the function and mode of operation of the ACE products – quickly and easily. At our place or yours!

Please also use our contact form at [www.ace-ace.com](http://www.ace-ace.com)

### Yes. We are interested in

- the new ACE catalogue
- a training in the demonstration vehicle
- product presentations in our premises
- a lecture at our site
- technical assistance at our site

### Topic

- Automation Control
- Motion Control
- Vibration Control
- Safety Products

### Your contact information

|                 |  |
|-----------------|--|
| Company         |  |
| Name            |  |
| Function        |  |
| Department      |  |
| Address         |  |
| ZIP Code / City |  |
| Telephone       |  |
| Fax             |  |
| E-Mail          |  |
| Internet        |  |

**Please copy, complete and fax to +49 (0)2173 - 9226-89**



in Countries without ACE Facility

**ARGENTINA**

CAMOZZI NEUMATICA S.A.  
Prof. Dr. Pedro Chutro 3048  
1437 Buenos Aires, Argentina  
T +54 11 49110816  
F +54 11 49124191  
www.camozzi.com.ar

**AUSTRIA**

ACE STOSSDÄMPFER GMBH  
Albert-Einstein-Straße 15, 40764 Langenfeld, Germany  
T +49 2173-9226-4000  
F +49 2173-9226-29  
www.ace-ace.de  
(distributors on request)

**BELARUS**

BIBUS (BY) COOO  
8th Per. Ilyicha 13a, office 2.1  
246013 Gomel, Belarus  
T +375 232 29 31 39  
F +375 232 39 59 02  
www.bibus.by  
(not distributor for gas springs and HB dampers)

**Gas spring & HB damper specialists:**

TECHVITASBEL LLC  
F. Skaryny str. 15B-3  
220114 Minsk, Belarus  
T +375 17 396 63 83  
F +375 17 396 63 82  
www.techvitas.by  
(not distributor for shock absorbers, TUBUS, SLAB)

**BELGIUM**

ACE STOSSDÄMPFER GMBH  
Albert-Einstein-Straße 15, 40764 Langenfeld, Germany  
T +32 11-960736  
F +32 11-960737  
www.ace-ace.com  
(distributors on request)

**BOSNIA AND HERZEGOVINA**

BIBUS DOO  
Karadordeva, 76311 Dvorovi – Bijeljina  
Bosnia and Herzegovina  
T +387 55 423 444  
F +387 55 423 444  
www.bibus.ba  
(not distributor for gas springs and HB dampers)

**For gas springs & HB dampers:**

ACE STOSSDÄMPFER GMBH  
Albert-Einstein-Straße 15, 40764 Langenfeld, Germany  
T +49 2173-9226-4100  
F +49 2173-9226-89  
www.ace-ace.com

**BRAZIL**

OBR EQUIPAMENTOS  
INDUSTRIAIS LTDA.  
Rua Florianópolis, 431, Mooca-São Paulo – SP.  
CEP 03185-050, Brazil  
T +55 11-2067 3698 / 0800704 3698  
www.obr.com.br

**BULGARIA**

BIBUS BULGARIA LTD.  
Tzvetan Lazarov Blv. 2, floor 2, 1574 Sofia, Bulgaria  
T +359 2 971 98 08  
F +359 2 927 32 64  
www.bibus.bg  
(not distributor for gas springs and HB dampers)

**For gas springs & HB dampers:**

ACE STOSSDÄMPFER GMBH  
Albert-Einstein-Straße 15, 40764 Langenfeld, Germany  
T +49 2173-9226-4100  
F +49 2173-9226-89  
www.ace-ace.com

**CHILE**

TAYLOR AUTOMATIZACION S.A.  
Santiago De Urióna 1854, Quinta Normal  
8500000 - Santiago, Chile  
T +56 2 2555 1516  
F +56 2 2544 1965  
www.taylorsa.cl

**CROATIA**

BIBUS ZAGREB D.O.O.  
Anina 91, 10000 Zagreb, Croatia  
T +385 1 3818 004  
F +385 1 3818 005  
www.bibus.hr  
(not distributor for gas springs and HB dampers)

**For gas springs & HB dampers:**

ACE STOSSDÄMPFER GMBH  
Albert-Einstein-Straße 15, 40764 Langenfeld, Germany  
T +49 2173-9226-4100  
F +49 2173-9226-89  
www.ace-ace.com

**CZECH REPUBLIC**

BIBUS S.R.O.  
Videnska 125, 639 27 Brno, Czech Republic  
T +420 547 125 300  
F +420 547 125 310  
www.bibus.cz  
(not distributor for gas springs and HB dampers)

**Gas spring & HB damper specialists:**

MN-SYSTEMS, S.R.O.  
Na Honech I/5538, 760 05 Zlín, Czech Republic  
T +420 734 200 172  
F +420 246 013 937  
www.mnsystems.cz

**DENMARK**

AVN TEKNIK A/S  
Dalager 1, 2605 Broendby, Denmark  
T +45 70 20 04 11  
F +45 43 24 55 00  
www.avn.dk

**ESTONIA**

TECHVITAS OÜ  
Peterburi tee 81-510, Tallinn 11415, Estonia  
T +372 5670 0702  
www.techvitas.ee

**FINLAND**

NESTEPAINE OY  
Makituvantie 11, 01510 Vantaa, Finland  
T +358 20 765 165  
F +358 20 765 7666  
www.nestepaine.fi

**MOVETEC OY**

Hannuksentie 1, 02270 Espoo, Finland  
T +358 9 5259 230  
F +358 9 5259 2333  
www.movetec.fi

**FRANCE**

BIBUS FRANCE  
ZA du Chapotin, 233 rue des Frères Voisin  
69970 Chaponnay, France  
T +33 4 78 96 80 00  
F +33 4 78 96 80 01  
www.bibusfrance.fr  
(not distributor for gas springs and HB dampers)

**For gas springs & HB dampers:**

ACE STOSSDÄMPFER GMBH  
Albert-Einstein-Straße 15, 40764 Langenfeld, Germany  
T +49 2173-9226-4100  
F +49 2173-9226-89  
www.ace-ace.com

**GREECE**

PNEUMATEC INDUSTRIAL  
AUTOMATION SYSTEMS  
91 Spirou Patsi Street, Athens 11855, Greece  
T +302 1 03412101 / 3413930  
F +302 1 03413930

**HUNGARY**

BIBUS KFT.  
Almáskert út 9, 2220 Vecsés, Hungary  
T +36 29 557 763  
F +36 29 557 777  
www.bibus.hu  
(not distributor for gas springs and HB dampers)

**Gas spring & HB damper specialists:**

DUNA CONSULTING KFT.  
Gábor Áron u. 18, 2013 Pomáz, Hungary  
T +36 1 433 4700, +36-30 26 36 576  
F +36 1 264 8900  
www.acegazrugo.hu

**INDIA**

SHREEJI MARKETING CORPORATION  
2& 3, 1st Floor, Pride Plaza, Mumbai-Pune Road  
Pimpri, Pune - 411018, India  
T +91 20 2742 0897  
F +91 20 2742 0997  
www.shreejimt.com

**IRELAND**

IRISH PNEUMATIC SERVICES LTD.  
5A M7 Business Park  
Newhall, Naas, Co. Kildare, Ireland  
T +353 45-872590  
F +353 45-872595  
www.irishpneumaticservices.com

**ISRAEL**

ILAN & GAVISH AUTOMATION SERVICE LTD.  
26, Shenkar Street, Qiryat-arie 49513  
PO Box 10118, 49001 Petah-Tiqva, Israel  
T +972 39 22 18 24  
F +972 39 24 07 61  
www.ilan-gavish.co.il

**ITALY**

R.T.I. S.R.L.  
Via Chambery 93/107V, 10142 Torino, Italy  
T +39 011-70 00 53 / 70 02 32  
F +39 011-70 01 41  
www.rti-to.it

**JORDAN**

ATAFAWOK TRADING EST.  
PO Box 921797, Amman 11192, Jordan  
T +962 64 02 38 73  
F +962 65 92 63 25

**LATVIA**

TECHVITAS SIA  
38 Daugavas Street, Marupe  
2167 Marupes nov., Latvia  
T +371 27 530 003  
F +371 29 847 378  
www.techvitas.lv

**LITHUANIA**  
**TECHVITAS UAB**

Dubysos g. 66A, 94107 Klaipeda, Lithuania  
T +370 46 355 494  
F +370 46 355 493  
www.techvitas.lt

**LUXEMBOURG**
**ACE STOSSDÄMPFER GMBH**

Albert-Einstein-Straße 15, 40764 Langenfeld, Germany  
T +32 11-960736  
F +32 11-960737  
www.ace-ace.com  
(distributors on request)

**NETHERLANDS**
**ACE STOSSDÄMPFER GMBH**

Albert-Einstein-Straße 15, 40764 Langenfeld, Germany  
T +31 165-714455  
F +31 165-714456  
www.ace-ace.com  
(distributors on request)

**NORWAY**
**ACE STOSSDÄMPFER GMBH**

Albert-Einstein-Straße 15, 40764 Langenfeld, Germany  
T +49 2173-9226-4100  
F +49 2173-9226-89  
www.ace-ace.com

**HYDNET AB**

Turebergsvagen 5, 191 47 Sollentuna, Sweden  
T +46 8 59 470 470  
F +46 8 59 470 479  
www.hydnet.se

**PAKISTAN**
**JJ HYDRAULIC PNEUMATIC**

SYSTEMS (PVT) LTD.  
41 # Old Ralli Building, Talpur Road,  
Off, I I Chundrigar Road, Karachi – 74000, Pakistan  
Dir no. 0092 0333 2229606  
T +92 21 32426486 / 32426516  
F +92 21 32416807

**POLAND**
**BIBUS MENOS SP. Z.O.O.**

ul. Spadochroniarzy 18, 80-298 Gdańsk, Poland  
T +48 58 660 95 70  
F +48 58 661 71 32  
www.bibusmenos.pl  
(not distributor for gas springs and HB dampers)

**Gas spring & HB damper specialists:**

F.H.U. ELMATIC S.C.  
ul. Marii Skłodowskiej - Curie 73 A  
87-100 Toruń, Poland  
T / F +48 56 659 16 81  
T +48 56 659 15 49, +48-56 653 98 10  
www.elmatic.com.pl

**PORTUGAL**
**AIRCONTROL INDUSTRIAL S.L.**

Alameda Fernao Lopes 31A, Torre 2 - Miraflores  
1495-136 Alges (Lisboa), Portugal  
T +351 21 410 13 57  
F +351 21 410 56 08  
www.aircontrol.es

**BIBUS PORTUGAL LDA**

Centro Empresarial AAA, Rua Ponte da Pedra, 240 – C4  
4470-108 Gueifães - Maia, Portugal  
T +351 22 906 50 50  
F +351 22 906 50 53  
www.bibus.pt  
(not distributor for gas springs and HB dampers)

**ROMANIA**
**BIBUS SES S.R.L.**

134/1 Calea Lugojului, 307200 Ghiroda, Timis, Romania  
T +40 356 446 500  
F +40 356 446 660  
www.bibus.ro  
(not distributor for gas springs and HB dampers)

**Gas spring & HB damper specialists:**

D.C. COMPANY S.R.L.  
Dragos Voda nr. 43, 300351 Timisoara, Romania  
T +40 722 145 213  
F +40 356 800 513  
www.ewarehouse.ro

**RUSSIA**
**BIBUS O.O.O.**

Str Zemskaja 94, 198205 St. Petersburg, Russia  
T/F +7 812 309 41 51  
T +7 800 100 14 52  
www.bibus.ru  
(not distributor for gas springs and HB dampers)

**Gas spring & HB damper specialists:**

TEHINNOVATION O.O.O.  
Krasnodonskaya street 19, building 2, office 17  
109386 Moscow, Russia  
T +7 495 222 06 01  
F +7 499 786 42 56  
www.tehinnovation.ru

**SERBIA**
**BIBUS DOO**

Karadordeva, 76311 Dvorovi – Bijeljina  
Bosnia and Herzegovina  
T +387 55 423 444  
F +387 55 423 444  
www.bibus.ba  
(not distributor for gas springs and HB dampers)

**For gas springs & HB dampers:**

ACE STOSSDÄMPFER GMBH  
Albert-Einstein-Straße 15, 40764 Langenfeld, Germany  
T +49 2173-9226-4100  
F +49 2173-9226-89  
www.ace-ace.com

**SLOVAKIA**
**BIBUS SK S.R.O.**

Trnavska cesta, 94901 Nitra, Slovakia  
T +421 37 77 77 950  
F +421 37 77 77 969  
www.bibus.sk  
(not distributor for gas springs and HB dampers)

**Gas spring & HB damper specialists:**

PNEUTRADE S.R.O.  
Rybárska 8, 949 01 Nitra, Slovakia  
T +421 37 65 24 338  
F +421 37 65 55 933  
www.pneutrade.sk

**SLOVENIA**
**INOTEH D.O.O.**

K Zeleznici 7, 2345 Bistrica ob Dravi, Slovenia  
T +386 (0)2 665 1131  
F +386 (0)2 665 2081  
www.inoteh.si  
(not distributor for gas springs and HB dampers)

**For gas springs & HB dampers:**

ACE STOSSDÄMPFER GMBH  
Albert-Einstein-Straße 15, 40764 Langenfeld, Germany  
T +49 2173-9226-4100  
F +49 2173-9226-89  
www.ace-ace.com

**SOUTH AFRICA**
**PNEUMARK CONTROLS**

94A Crompton Street, Pinetown 3610, South Africa  
T +27 31 701 0421  
F +27 86 551 2026  
www.pneumark.co.za

**SPAIN**
**AIRCONTROL INDUSTRIAL S.L.**

Paseo Sarroeta 4  
20014 Donostia-San Sebastian, Spain  
T +34 943 44 50 80  
F +34 943 44 51 53  
www.aircontrol.es

**BIBUS SPAIN S.L.**

Poligono Industrial Porto do Molle  
Rua do Aroncal, Vial C – Nave 4A  
36350 Nigran (Pontevedra), Spain  
T +34 986 24 72 86  
F +34 986 20 92 47  
www.bibus.es  
(not distributor for gas springs and HB dampers)

**SWEDEN**
**HYDNET AB**

Turebergsvagen 5, 191 47 Sollentuna, Sweden  
T +46 8 59 470 470  
F +46 8 59 470 479  
www.hydnet.se

**SWITZERLAND**
**BIBUS AG**

Allmendstrasse 26, 8320 Fehraltorf, Switzerland  
T +41 44-877 50 11  
F +41 44-877 58 51  
www.bibus.ch  
(not distributor for gas springs and HB dampers)

**For gas springs & HB dampers:**

ACE STOSSDÄMPFER GMBH  
Albert-Einstein-Straße 15, 40764 Langenfeld, Germany  
T +49 2173-9226-4100  
F +49 2173-9226-89  
www.ace-ace.com

**TURKEY**
**BIBUS OTOMASYON SAN. VE TIC.LTD.STI.**

Ziya Gökalp Mh. Bedrettin Dalan Bulv.  
VIP Plaza No:43-44 İkitelli  
Bağaçşehir / İstanbul, Turkey  
T +90-212 293 82 00  
F +90-212 249 88 34  
www.bibus.com.tr  
(not distributor for gas springs and HB dampers)

**Gas spring & HB damper specialists:**

POVVER PNÖMATİK A.S.  
Necatibey Cad. No:44 Kat:2  
34425 Karaköy/İstanbul, Turkey  
T +90 212 293 88 70  
F +90 212 293 68 77  
www.powerpnomatik.com

**UKRAINE**
**BIBUS UKRAINE TOV**

1B, Kyivs'ka Str., Tarasivka  
08161 Kyiv region, Ukraine  
T +38 (044) 545 44 04  
F +38 (044) 545 54 83  
www.bibus.ua  
(not distributor for gas springs and HB dampers)

**Gas spring & HB damper specialists:**

TECHVITAS LLC  
Pyrohivskiy shliakh St 28, 03680 Kyiv, Ukraine  
T +38 (050) 800 77 98 und +38 (044) 503-01-51  
www.techvitas.com.ua

## ACE Germany

The shortest way to the perfect shock absorber



### ACE Stoßdämpfer GmbH

PO Box 1510  
40740 Langenfeld

Albert-Einstein-Straße 15  
40764 Langenfeld

Germany

T +49 (0)2173 - 9226-4100

F +49 (0)2173 - 9226-89



[info@ace-int.eu](mailto:info@ace-int.eu)

[www.ace-ace.com](http://www.ace-ace.com)

## Global but always near

### International ACE Sales Locations



GREAT BRITAIN  
**ACE Fabreeka UK**

Unit 404 Easter Park, Haydock Lane  
Haydock, WA11 9TH, U.K.

T +44 (0)1942 - 727 440

F +44 (0)1942 - 717 273

[www.ace-controls.co.uk](http://www.ace-controls.co.uk)



JAPAN  
**ACE Controls Japan L.L.C.**

City Center Bldg. II 2fl  
3-1-42, Chigasaki-minami, Tsuzuki-ku  
Yokohama, 224-0037, Japan

T +81 (0)45 - 945-0123

F +81 (0)45 - 945-0122

[www.acecontrols.co.jp](http://www.acecontrols.co.jp)

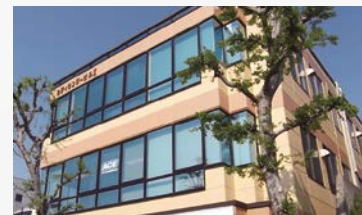

P.R. CHINA  
**ACE Controls**

No. 8 Longxiang Road, Wujin National High-tech Industrial Zone,  
Changzhou, Jiangsu Province, CN-213164, P. R. China

T +86 (0)519 - 8622-3520

F +86 (0)519 - 8622-3550

[www.ace-ace.cn](http://www.ace-ace.cn)



USA  
**ACE Controls International Inc.**

23425 Industrial Park Dr., Farmington Hills  
Michigan 48335, USA

T +1 248 - 476-0213

F +1 248 - 476-2470

[www.acecontrols.com](http://www.acecontrols.com)

